



## 100mW STEREO HEADPHONE AMPLIFIER WITH STANDBY MODE

- OPERATING FROM  $V_{CC}=2V$  to 5.5V
- **STANDBY MODE ACTIVE LOW** (TS486) or HIGH (TS487)
- **OUTPUT POWER:** 102mW @5V, 38mW @3.3V into 16Ω with 0.1% THD+N max (1kHz)
- **LOW CURRENT CONSUMPTION:** 2.5mA max
- High Signal-to-Noise ratio: 103dB(A) at 5V
- High Crosstalk immunity: 83dB (F=1kHz)
- **PSRR:** 58 dB (F=1kHz), inputs grounded
- ON/OFF click reduction circuitry
- Unity-Gain Stable
- **SHORT CIRCUIT LIMITATION**
- Available in SO8, MiniSO8 & DFN 3x3mm

### DESCRIPTION

The TS486/7 is a dual audio power amplifier capable of driving, in single-ended mode, either a 16 or a 32Ω stereo headset.

Capable of descending to low voltages, it delivers up to 90mW per channel (into 16Ω loads) of continuous average power with 0.3% THD+N in the audio bandwidth from a 5V power supply.

An externally-controlled standby mode reduces the supply current to 10nA (typ.). The unity gain stable TS486/7 can be configured by external gain-setting resistors or used in a fixed gain version.

### APPLICATIONS

- Headphone Amplifier
- Mobile phone, PDA, computer motherboard
- High end TV, portable audio player

### ORDER CODE

Part Number	Temperature Range: I	Package			Gain	Marking
		D	S	Q		
TS486	-40, +85°C	•			external	TS486I
TS487		•			external	TS487I
TS486			•	•	external	K86A
TS486-1		tba	tba		x1/0dB	K86B
TS486-2		tba	tba		x2/6dB	K86C
TS486-4		tba	tba		x4/12dB	K86D
TS487		•	•		external	K87A
TS487-1		tba	tba		x1/0dB	K87B
TS487-2		tba	tba		x2/6dB	K87C
TS487-4		tba	tba		x4/12dB	K87D

MiniSO & DFN only available in Tape & Reel with T suffix, SO is available in Tube (D) and in Tape & Reel (DT)

### PIN CONNECTIONS (top view)

**TS486IDT: SO8, TS486IST, TS486-1IST, TS486-2IST, TS486-4IST: MiniSO8**

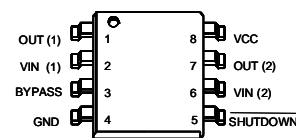

**TS486-IQT, TS486-1IQT, TS486-2IQT, TS486-4IQT: DFN8**

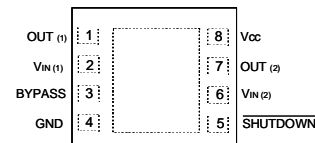

**TS487IDT: SO8, TS487IST, TS487-1IST, TS487-2IST, TS487-4IST: MiniSO8**

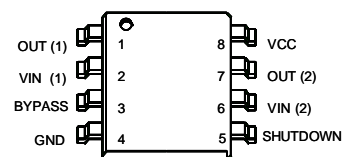

**TS487-IQT, TS487-1IQT, TS487-2IQT, TS487-4IQT: DFN8**

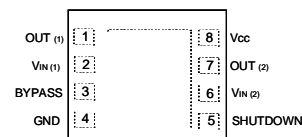

**ABSOLUTE MAXIMUM RATINGS**

Symbol	Parameter	Value	Unit
V <sub>CC</sub>	Supply voltage <sup>1)</sup>	6	V
V <sub>i</sub>	Input Voltage	-0.3v to V <sub>CC</sub> +0.3v	V
T <sub>stg</sub>	Storage Temperature	-65 to +150	°C
T <sub>j</sub>	Maximum Junction Temperature	150	°C
R <sub>thja</sub>	Thermal Resistance Junction to Ambient SO8 MiniSO8 DFN8	175 215 70	°C/W
Pd	Power Dissipation <sup>2)</sup> SO8 MiniSO8 DFN8	0.71 0.58 1.79	W
ESD	Human Body Model (pin to pin): TS486, TS487 <sup>3)</sup>	1.5	kV
ESD	Machine Model - 220pF - 240pF (pin to pin)	100	V
Latch-up	Latch-up Immunity (All pins)	200	mA
	Lead Temperature (soldering, 10sec)	250	°C
	Output Short-Circuit to V <sub>cc</sub> or GND	continuous <sup>4)</sup>	

1. All voltage values are measured with respect to the ground pin.
2. Pd has been calculated with Tamb = 25°C, Tjunction = 150°C.
3. TS487 stands 1.5KV on all pins except standby pin which stands 1KV.
4. Attention must be paid to continuous power dissipation (V<sub>DD</sub> x 300mA). Exposure of the IC to a short circuit for an extended time period is dramatically reducing product life expectancy.

**OPERATING CONDITIONS**

Symbol	Parameter	Value	Unit
V <sub>CC</sub>	Supply Voltage	2 to 5.5	V
R <sub>L</sub>	Load Resistor	≥ 16	Ω
T <sub>oper</sub>	Operating Free Air Temperature Range	-40 to + 85	°C
C <sub>L</sub>	Load Capacitor R <sub>L</sub> = 16 to 100Ω R <sub>L</sub> > 100Ω	400 100	pF
V <sub>STB</sub>	Standby Voltage Input TS486 ACTIVE / TS487 in STANDBY TS486 in STANDBY / TS487 ACTIVE	1.5 ≤ V <sub>STB</sub> ≤ V <sub>CC</sub> GND ≤ V <sub>STB</sub> ≤ 0.4 <sup>1)</sup>	V
R <sub>THJA</sub>	Thermal Resistance Junction to Ambient SO8 MiniSO8 DFN8 <sup>2)</sup>	150 190 41	°C/W

1. The minimum current consumption (I<sub>STANDBY</sub>) is guaranteed at GND (TS486) or V<sub>CC</sub> (TS487) for the whole temperature range.
2. When mounted on a 4-layer PCB.

**FIXED GAIN VERSION SPECIFIC ELECTRICAL CHARACTERISTICS**

V<sub>CC</sub> from +5V to +2V, GND = 0V, T<sub>amb</sub> = 25°C (unless otherwise specified)

Symbol	Parameter	Min.	Typ.	Max.	Unit
R <sub>IN 1,2</sub>	Input Resistance <sup>1)</sup>		20		kΩ
G	Gain value for Gain TS486/TS487-1 Gain value for Gain TS486/TS487-2 Gain value for Gain TS486/TS487-4		0dB 6dB 12dB		dB

1. See figure 30 to establish the value of C<sub>in</sub> vs. -3dB cut off frequency.

**APPLICATION COMPONENTS INFORMATION**

Components	Functional Description
R <sub>IN1,2</sub>	Inverting input resistor which sets the closed loop gain in conjunction with R <sub>FEED</sub> . This resistor also forms a high pass filter with C <sub>IN</sub> ( $f_c = 1 / (2 \times \text{Pi} \times R_{IN} \times C_{IN})$ ). <b>Not needed in fixed gain versions.</b>
C <sub>IN1,2</sub>	Input coupling capacitor which blocks the DC voltage at the amplifier's input terminal.
R <sub>FEED1,2</sub>	Feedback resistor which sets the closed loop gain in conjunction with R <sub>IN</sub> . $A_v = \text{Closed Loop Gain} = -R_{FEED}/R_{IN}$ . <b>Not needed in fixed gain versions.</b>
C <sub>S</sub>	Supply Bypass capacitor which provides power supply filtering.
C <sub>B</sub>	Bypass capacitor which provides half supply filtering.
C <sub>OUT1,2</sub>	Output coupling capacitor which blocks the DC voltage at the load input terminal. This capacitor also forms a high pass filter with R <sub>L</sub> ( $f_c = 1 / (2 \times \text{Pi} \times R_L \times C_{OUT})$ ).

**TYPICAL APPLICATION SCHEMATICS**

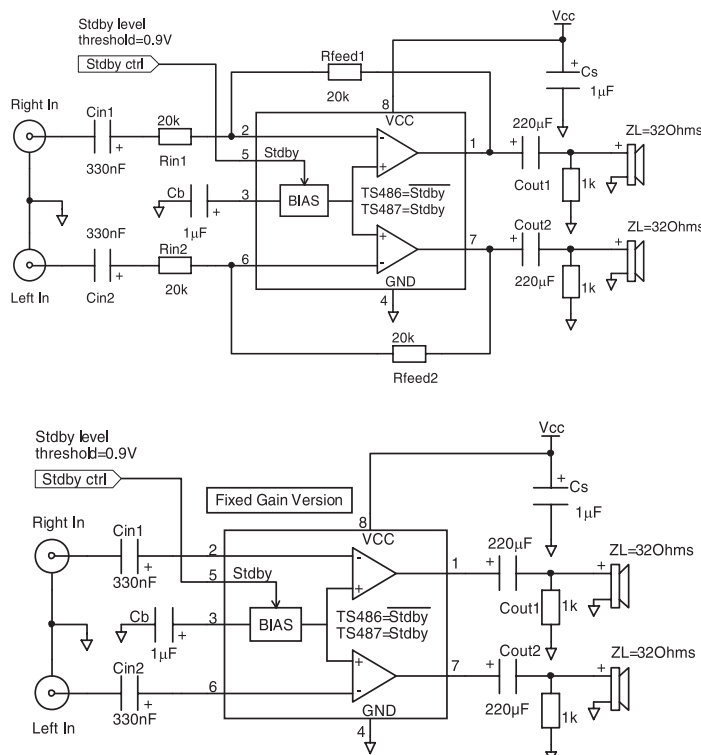

**ELECTRICAL CHARACTERISTICS**
 $V_{CC} = +5V$ ,  $GND = 0V$ ,  $T_{amb} = 25^{\circ}C$  (unless otherwise specified)

Symbol	Parameter	Min.	Typ.	Max.	Unit
$I_{CC}$	Supply Current No input signal, no load		1.8	2.5	mA
$I_{STANDBY}$	Standby Current No input signal, $V_{STANDBY}=GND$ for TS486, $R_L=32\Omega$ No input signal, $V_{STANDBY}=V_{CC}$ for TS487, $R_L=32\Omega$		10	1000	nA
$V_{IO}$	Input Offset Voltage ( $V_{ICM} = V_{CC}/2$ )		1		mV
$I_{IB}$	Input Bias Current ( $V_{ICM} = V_{CC}/2$ ) <sup>1)</sup>		90	200	nA
$P_O$	Output Power THD+N = 0.1% Max, F = 1kHz, $R_L = 32\Omega$ THD+N = 1% Max, F = 1kHz, $R_L = 32\Omega$ THD+N = 0.1% Max, F = 1kHz, $R_L = 16\Omega$ THD+N = 1% Max, F = 1kHz, $R_L = 16\Omega$	60 95	64 65 102 108		mW
THD + N	Total Harmonic Distortion + Noise ( $A_v=-1$ ) $R_L = 32\Omega$ , $P_{out} = 60mW$ , $20Hz \leq F \leq 20kHz$ $R_L = 16\Omega$ , $P_{out} = 90mW$ , $20Hz \leq F \leq 20kHz$		0.3 0.3		%
PSRR	Power Supply Rejection Ratio, inputs grounded <sup>2)</sup> ( $A_v=-1$ ), $R_L \geq 16\Omega$ , $C_B=1\mu F$ , F = 1kHz, $V_{ripple} = 200mV_{pp}$	53	58		dB
$I_O$	Max Output Current THD + N $\leq 1\%$ , $R_L = 16\Omega$ connected between out and $V_{CC}/2$	106	115		mA
$V_O$	Output Swing $V_{OL} : R_L = 32\Omega$ $V_{OH} : R_L = 32\Omega$ $V_{OL} : R_L = 16\Omega$ $V_{OH} : R_L = 16\Omega$	4.45 4.2	0.45 4.52 0.6 4.35	0.5 0.7	V
SNR	Signal-to-Noise Ratio (A weighted, $A_v=-1$ ) <sup>2)</sup> ( $R_L = 32\Omega$ , THD + N < 0.4%, $20Hz \leq F \leq 20kHz$ )	80	103		dB
Crosstalk	Channel Separation, $R_L = 32\Omega$ , $A_v=-1$ F = 1kHz F = 20Hz to 20kHz Channel Separation, $R_L = 16\Omega$ , $A_v=-1$ F = 1kHz F = 20Hz to 20kHz		83 79 80 72		dB
$C_I$	Input Capacitance		1		pF
GBP	Gain Bandwidth Product ( $R_L = 32\Omega$ )		1.1		MHz
SR	Slew Rate, Unity Gain Inverting ( $R_L = 16\Omega$ )		0.4		V/ $\mu s$

1. Only for external gain version.

2. Guaranteed by design and evaluation.

## ELECTRICAL CHARACTERISTICS

$V_{CC} = +3.3V$ ,  $GND = 0V$ ,  $T_{amb} = 25^{\circ}C$  (unless otherwise specified) <sup>1)</sup>

Symbol	Parameter	Min.	Typ.	Max.	Unit
$I_{CC}$	Supply Current No input signal, no load		1.8	2.5	mA
$I_{STANDBY}$	Standby Current No input signal, $V_{STANDBY}=GND$ for TS486, $R_L=32\Omega$ No input signal, $V_{STANDBY}=V_{CC}$ for TS487, $R_L=32\Omega$		10	1000	nA
$V_{IO}$	Input Offset Voltage ( $V_{ICM} = V_{CC}/2$ )		1		mV
$I_{IB}$	Input Bias Current ( $V_{ICM} = V_{CC}/2$ ) <sup>2)</sup>		90	200	nA
$P_O$	Output Power THD+N = 0.1% Max, $F = 1kHz$ , $R_L = 32\Omega$ THD+N = 1% Max, $F = 1kHz$ , $R_L = 32\Omega$ THD+N = 0.1% Max, $F = 1kHz$ , $R_L = 16\Omega$ THD+N = 1% Max, $F = 1kHz$ , $R_L = 16\Omega$	23 36	26 28 38 42		mW
THD + N	Total Harmonic Distortion + Noise ( $A_v=-1$ ) $R_L = 32\Omega$ , $P_{out} = 16mW$ , $20Hz \leq F \leq 20kHz$ $R_L = 16\Omega$ , $P_{out} = 35mW$ , $20Hz \leq F \leq 20kHz$		0.3 0.3		%
PSRR	Power Supply Rejection Ratio, inputs grounded <sup>3)</sup> ( $A_v=-1$ ), $R_L \geq 16\Omega$ , $C_B=1\mu F$ , $F = 1kHz$ , $V_{ripple} = 200mV_{pp}$	53	58		dB
$I_O$	Max Output Current THD + N $\leq 1\%$ , $R_L = 16\Omega$ connected between out and $V_{CC}/2$	64	75		mA
$V_O$	Output Swing $V_{OL} : R_L = 32\Omega$ $V_{OH} : R_L = 32\Omega$ $V_{OL} : R_L = 16\Omega$ $V_{OH} : R_L = 16\Omega$	2.85 2.68	0.3 3 0.45 2.85	0.38 0.52	V
SNR	Signal-to-Noise Ratio (A weighted, $A_v=-1$ ) <sup>3)</sup> ( $R_L = 32\Omega$ , THD + N < 0.4%, $20Hz \leq F \leq 20kHz$ )	80	98		dB
Crosstalk	Channel Separation, $R_L = 32\Omega$ , $A_v=-1$ $F = 1kHz$ $F = 20Hz$ to $20kHz$ Channel Separation, $R_L = 16\Omega$ , $A_v=-1$ $F = 1kHz$ $F = 20Hz$ to $20kHz$		80 76 77 69		dB
$C_I$	Input Capacitance		1		pF
GBP	Gain Bandwidth Product ( $R_L = 32\Omega$ )		1.1		MHz
SR	Slew Rate, Unity Gain Inverting ( $R_L = 16\Omega$ )		0.4		V/ $\mu s$

1. All electrical values are guaranteed with correlation measurements at 2V and 5V.

2. Only for external gain version.

3. Guaranteed by design and evaluation.

**ELECTRICAL CHARACTERISTICS**
 $V_{CC} = +2.5V$ ,  $GND = 0V$ ,  $T_{amb} = 25^{\circ}C$  (unless otherwise specified)<sup>1)</sup>

Symbol	Parameter	Min.	Typ.	Max.	Unit
$I_{CC}$	Supply Current No input signal, no load		1.7	2.5	mA
$I_{STANDBY}$	Standby Current No input signal, $V_{STANDBY}=GND$ for TS486, $R_L=32\Omega$ No input signal, $V_{STANDBY}=V_{CC}$ for TS487, $R_L=32\Omega$		10	1000	nA
$V_{IO}$	Input Offset Voltage ( $V_{ICM} = V_{CC}/2$ )		1		mV
$I_{IB}$	Input Bias Current ( $V_{ICM} = V_{CC}/2$ ) <sup>2)</sup>		90	200	nA
$P_O$	Output Power THD+N = 0.1% Max, F = 1kHz, $R_L = 32\Omega$ THD+N = 1% Max, F = 1kHz, $R_L = 32\Omega$ THD+N = 0.1% Max, F = 1kHz, $R_L = 16\Omega$ THD+N = 1% Max, F = 1kHz, $R_L = 16\Omega$	12.5 17.5	13 14 21 22		mW
THD + N	Total Harmonic Distortion + Noise ( $A_v=-1$ ) $R_L = 32\Omega$ , $P_{out} = 10mW$ , $20Hz \leq F \leq 20kHz$ $R_L = 16\Omega$ , $P_{out} = 16mW$ , $20Hz \leq F \leq 20kHz$		0.3 0.3		%
PSRR	Power Supply Rejection Ratio, inputs grounded <sup>3)</sup> ( $A_v=-1$ ), $R_L \geq 16\Omega$ , $C_B=1\mu F$ , F = 1kHz, Vripple = 200mVpp	53	58		dB
$I_O$	Max Output Current THD +N $\leq 1\%$ , $R_L = 16\Omega$ connected between out and $V_{CC}/2$	45	56		mA
$V_O$	Output Swing $V_{OL} : R_L = 32\Omega$ $V_{OH} : R_L = 32\Omega$ $V_{OL} : R_L = 16\Omega$ $V_{OH} : R_L = 16\Omega$	2.14 1.97	0.25 2.25 0.35 2.15	0.32 0.45	V
SNR	Signal-to-Noise Ratio (A weighted, $A_v=-1$ ) <sup>3)</sup> ( $R_L = 32\Omega$ , THD +N < 0.4%, $20Hz \leq F \leq 20kHz$ )	80	95		dB
Crosstalk	Channel Separation, $R_L = 32\Omega$ , $A_v=-1$ F = 1kHz F = 20Hz to 20kHz Channel Separation, $R_L = 16\Omega$ , $A_v=-1$ F = 1kHz F = 20Hz to 20kHz		80 76 77 69		dB
$C_I$	Input Capacitance		1		pF
GBP	Gain Bandwidth Product ( $R_L = 32\Omega$ )		1.1		MHz
SR	Slew Rate, Unity Gain Inverting ( $R_L = 16\Omega$ )		0.4		V/ $\mu s$

1. All electrical values are guaranteed with correlation measurements at 2V and 5V.

2. Only for external gain version.

3. Guaranteed by design and evaluation.

**ELECTRICAL CHARACTERISTICS**

$V_{CC} = +2V$ ,  $GND = 0V$ ,  $T_{amb} = 25^{\circ}C$  (unless otherwise specified)

Symbol	Parameter	Min.	Typ.	Max.	Unit
$I_{CC}$	Supply Current No input signal, no load		1.7	2.5	mA
$I_{STANDBY}$	Standby Current No input signal, $V_{STANDBY}=GND$ for TS486, $R_L=32\Omega$ No input signal, $V_{STANDBY}=V_{CC}$ for TS487, $R_L=32\Omega$		10	1000	nA
$V_{IO}$	Input Offset Voltage ( $V_{ICM} = V_{CC}/2$ )		1		mV
$I_{IB}$	Input Bias Current ( $V_{ICM} = V_{CC}/2$ ) <sup>1)</sup>		90	200	nA
$P_O$	Output Power THD+N = 0.1% Max, F = 1kHz, $R_L = 32\Omega$ THD+N = 1% Max, F = 1kHz, $R_L = 32\Omega$ THD+N = 0.3% Max, F = 1kHz, $R_L = 16\Omega$ THD+N = 1% Max, F = 1kHz, $R_L = 16\Omega$	7 9.5	8 9 12 13		mW
THD + N	Total Harmonic Distortion + Noise ( $A_v=-1$ ) $R_L = 32\Omega$ , $P_{out} = 6.5mW$ , $20Hz \leq F \leq 20kHz$ $R_L = 16\Omega$ , $P_{out} = 8mW$ , $20Hz \leq F \leq 20kHz$		0.3 0.3		%
PSRR	Power Supply Rejection Ratio, inputs grounded <sup>2)</sup> ( $A_v=-1$ ), $R_L \geq 16\Omega$ , $C_B=1\mu F$ , F = 1kHz, $V_{ripple} = 200mV_{pp}$	52	57		dB
$I_O$	Max Output Current THD + N $\leq 1\%$ , $R_L = 16\Omega$ connected between out and $V_{CC}/2$	33	41		mA
$V_O$	Output Swing $V_{OL} : R_L = 32\Omega$ $V_{OH} : R_L = 32\Omega$ $V_{OL} : R_L = 16\Omega$ $V_{OH} : R_L = 16\Omega$	1.67 1.53	0.24 1.73 0.33 1.63	0.29 0.41	V
SNR	Signal-to-Noise Ratio (A weighted, $A_v=-1$ ) <sup>2)</sup> ( $R_L = 32\Omega$ , THD + N < 0.4%, $20Hz \leq F \leq 20kHz$ )	80	93		dB
Crosstalk	Channel Separation, $R_L = 32\Omega$ , $A_v=-1$ F = 1kHz F = 20Hz to 20kHz Channel Separation, $R_L = 16\Omega$ , $A_v=-1$ F = 1kHz F = 20Hz to 20kHz		80 76 77 69		dB
$C_I$	Input Capacitance		1		pF
GBP	Gain Bandwidth Product ( $R_L = 32\Omega$ )		1.1		MHz
SR	Slew Rate, Unity Gain Inverting ( $R_L = 16\Omega$ )		0.4		V/ $\mu s$

1. Only for external gain version.

2. Guaranteed by design and evaluation.

Index of Graphs

Description	Figure	Page
<b>Common Curves</b>		
Open Loop Gain and Phase vs Frequency	1 to 10	9 to 10
Current Consumption vs Power Supply Voltage	11	10
Current Consumption vs Standby Voltage	12 to 17	10 to 11
Output Power vs Power Supply Voltage	18 to 19	11 to 12
Output Power vs Load Resistor	20 to 23	12
Power Dissipation vs Output Power	24 to 27	12 to 13
Power Derating vs Ambient Temperature	28	13
Output Voltage Swing vs Supply Voltage	29	13
Low Frequency Cut Off vs Input Capacitor for fixed gain versions	30	13
<b>Curves With 0dB Gain Setting (<math>A_v=-1</math>)</b>		
THD + N vs Output Power	31 to 39	14 to 15
THD + N vs Frequency	40 to 42	15
Crosstalk vs Frequency	43 to 48	16
Signal to Noise Ratio vs Power Supply Voltage	49 to 50	17
PSRR vs Frequency	51 to 56	17 to 18
<b>Curves With 6dB Gain Setting (<math>A_v=-2</math>)</b>		
THD + N vs Output Power	57 to 65	19 to 20
THD + N vs Frequency	66 to 68	20
Crosstalk vs Frequency	69 to 72	21
Signal to Noise Ratio vs Power Supply Voltage	73 to 74	21
PSRR vs Frequency	75 to 79	22
<b>Curves With 12dB Gain Setting (<math>A_v=-4</math>)</b>		
THD + N vs Output Power	80 to 88	22 to 24
THD + N vs Frequency	89 to 91	24
Crosstalk vs Frequency	92 to 95	24
Signal to Noise Ratio vs Power Supply Voltage	96 to 97	25
PSRR vs Frequency	98 to 102	26



**Fig. 1: Open Loop Gain and Phase vs Frequency**

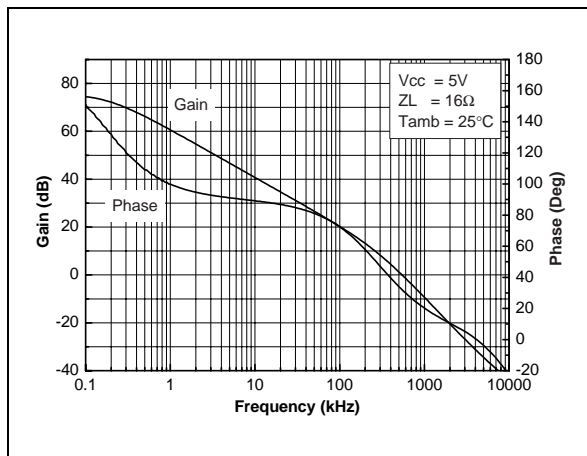

**Fig. 2: Open Loop Gain and Phase vs Frequency**

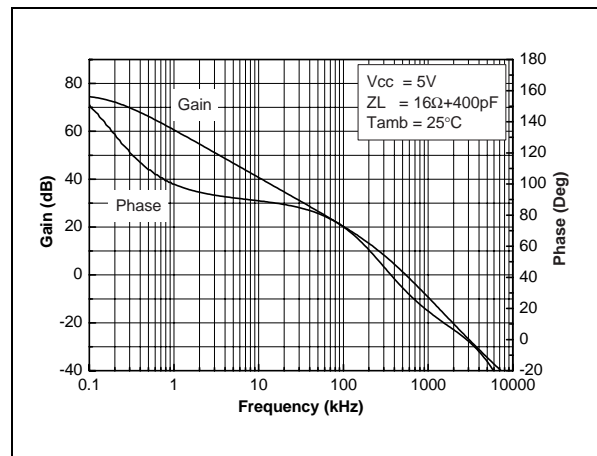

**Fig. 3: Open Loop Gain and Phase vs Frequency**

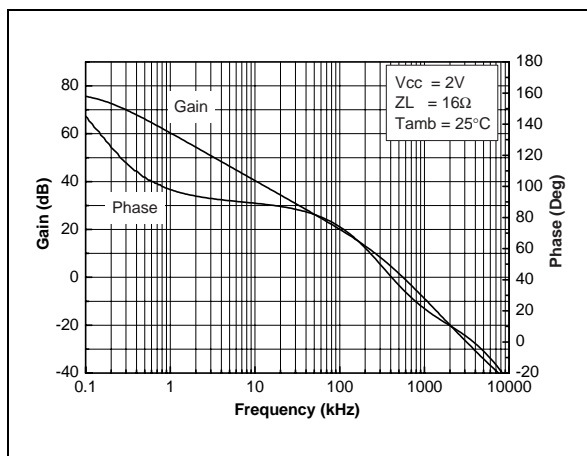

**Fig. 4: Open Loop Gain and Phase vs Frequency**

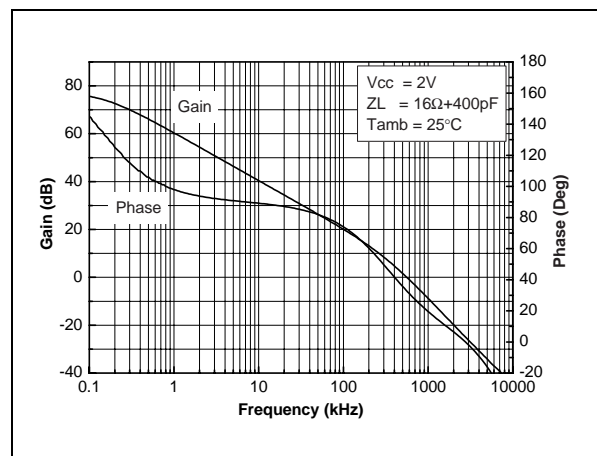

**Fig. 5: Open Loop Gain and Phase vs Frequency**

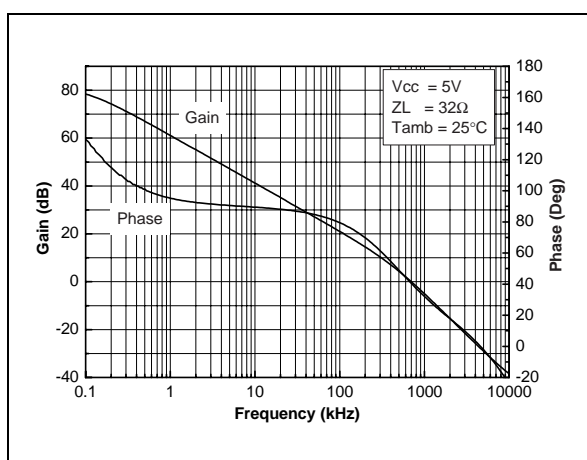

**Fig. 6: Open Loop Gain and Phase vs Frequency**

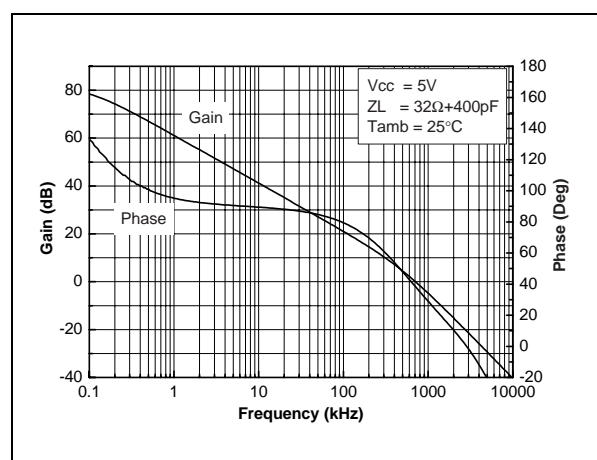

**Fig. 7: Open Loop Gain and Phase vs Frequency**

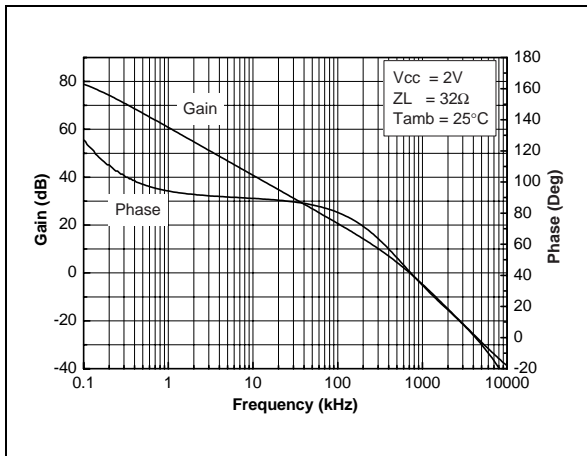

**Fig. 8: Open Loop Gain and Phase vs Frequency**

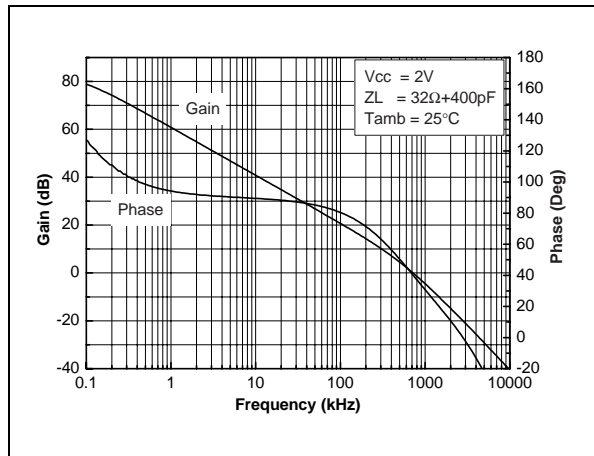

**Fig. 9: Open Loop Gain and Phase vs Frequency**

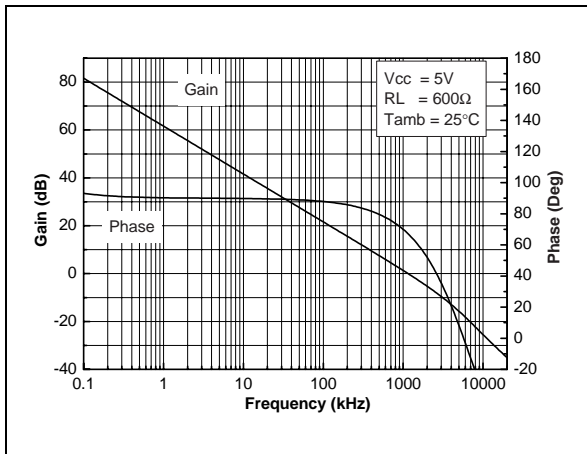

**Fig. 10: Open Loop Gain and Phase vs Frequency**

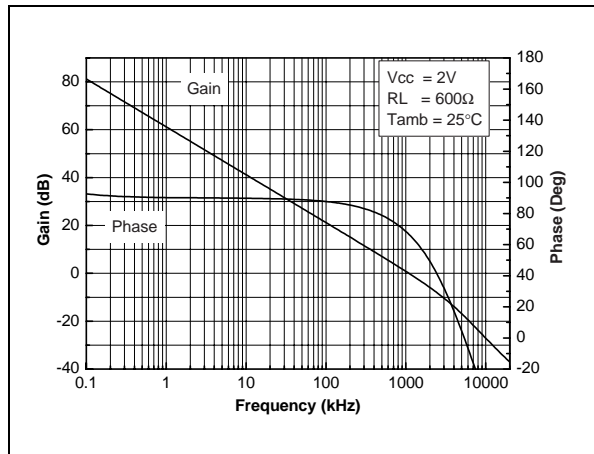

**Fig. 11: Current Consumption vs Power Supply Voltage**

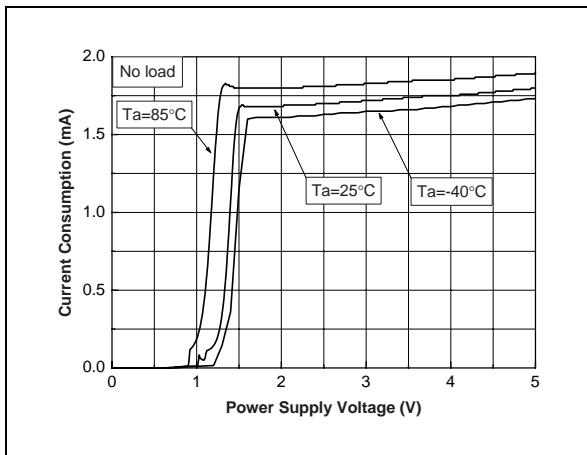

**Fig. 12: Current Consumption vs Standby Voltage**

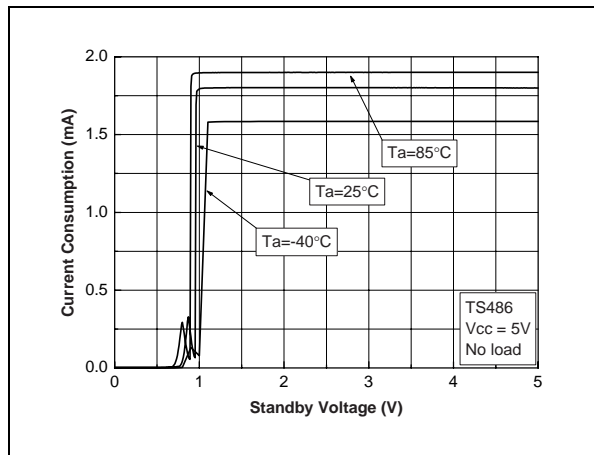

**Fig. 13: Current Consumption vs Standby Voltage**

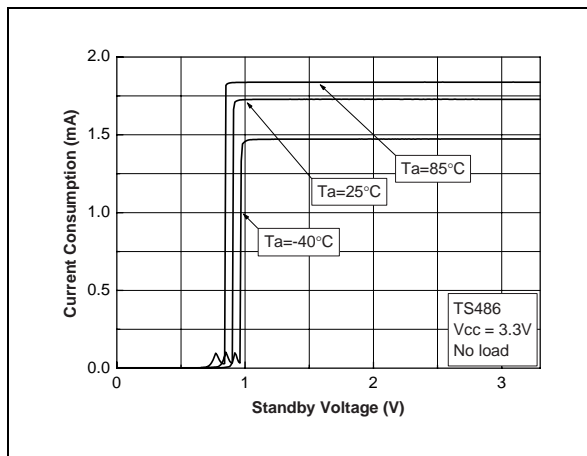

**Fig. 14: Current Consumption vs Standby Voltage**

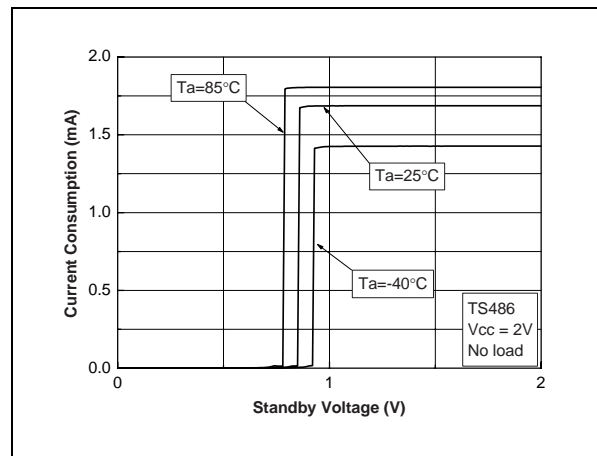

**Fig. 15: Current Consumption vs Standby Voltage**

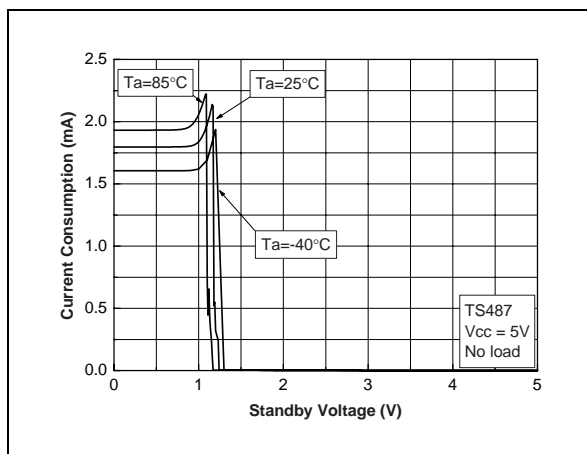

**Fig. 16: Current Consumption vs Standby Voltage**

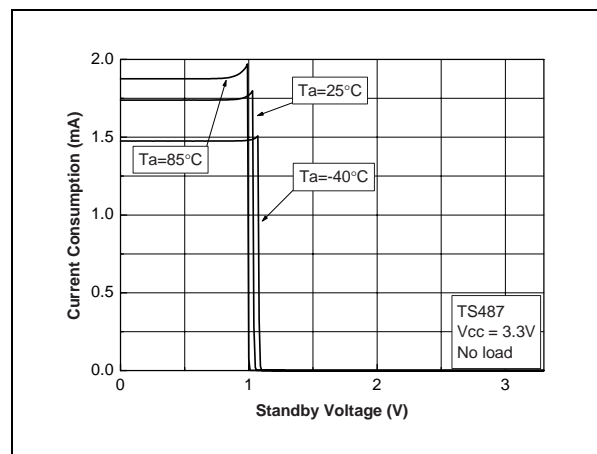

**Fig. 17: Current Consumption vs Standby Voltage**

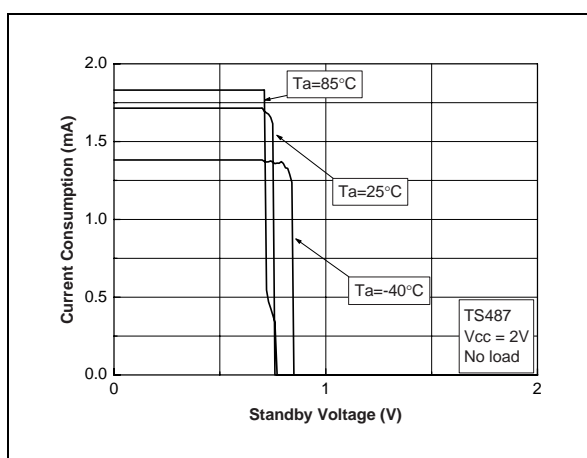

**Fig. 18: Output Power vs Power Supply Voltage**

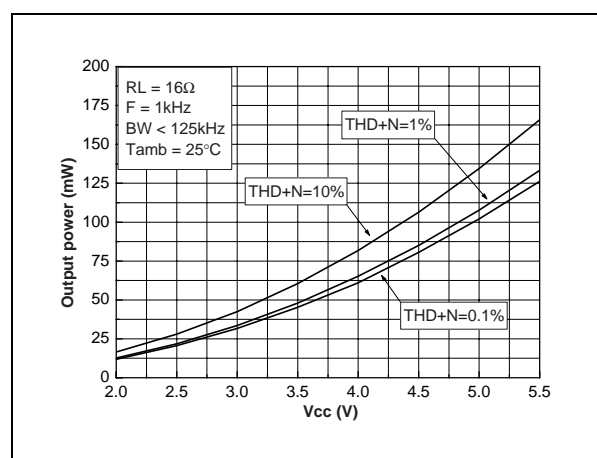

Fig. 19: Output Power vs Power Supply Voltage

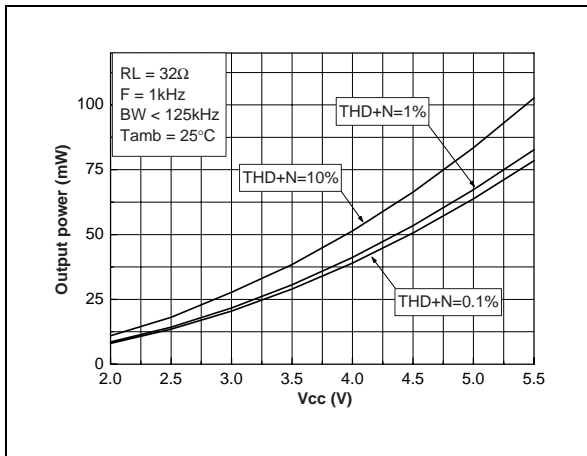

Fig. 20: Output Power vs Load Resistor

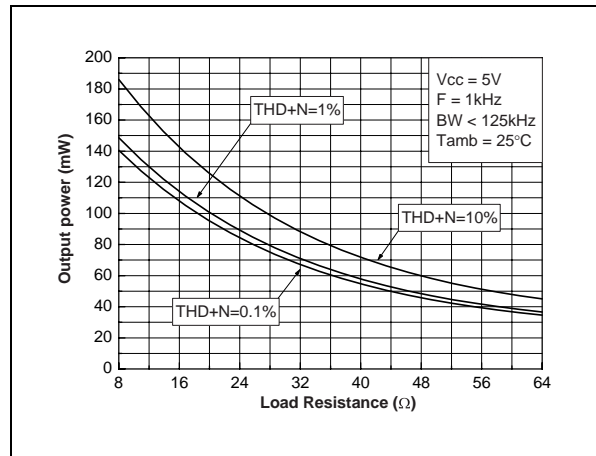

Fig. 21: Output Power vs Load Resistor

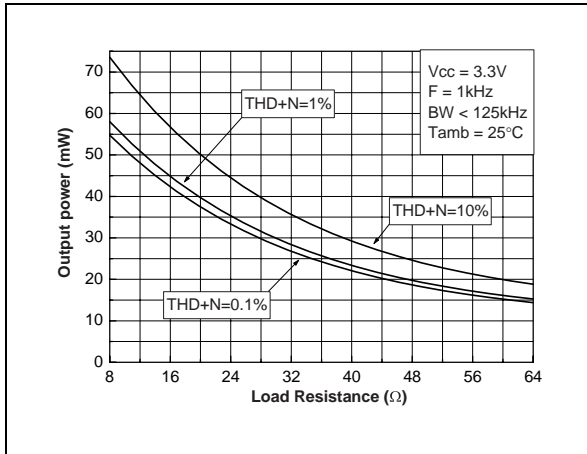

Fig. 22: Output Power vs Load Resistor

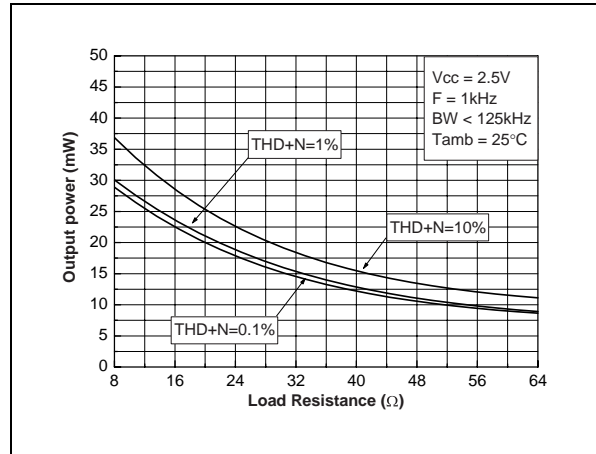

Fig. 23: Output Power vs Load Resistor

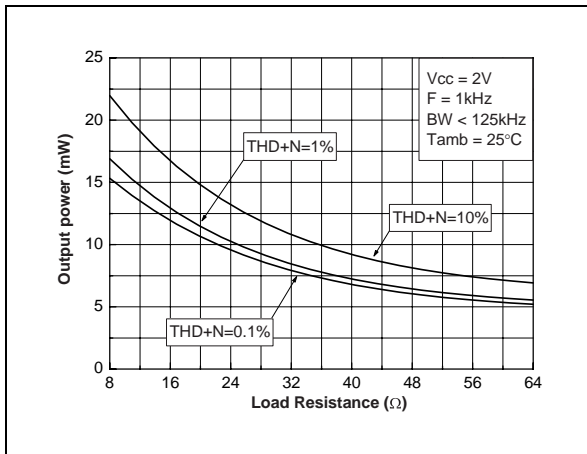

Fig. 24: Power Dissipation vs Output Power

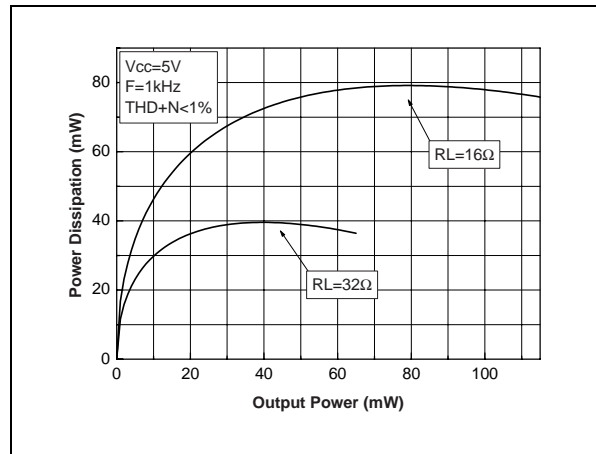

Fig. 25: Power Dissipation vs Output Power

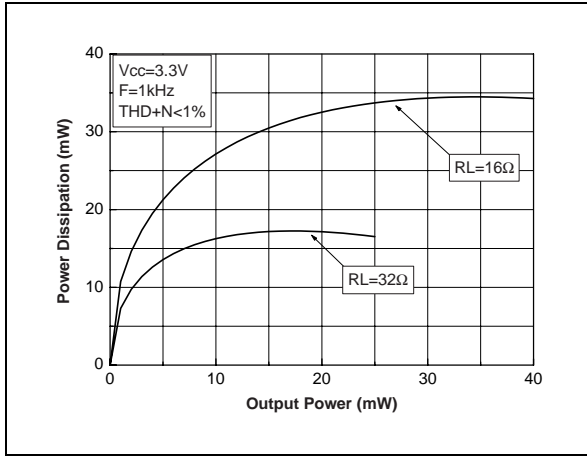

Fig. 26: Power Dissipation vs Output Power

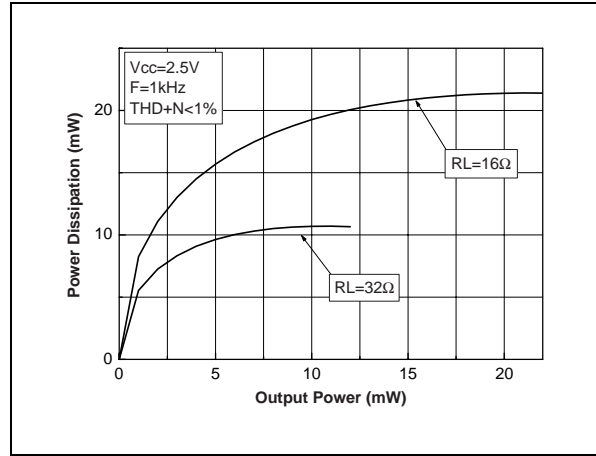

Fig. 27: Power Dissipation vs Output Power

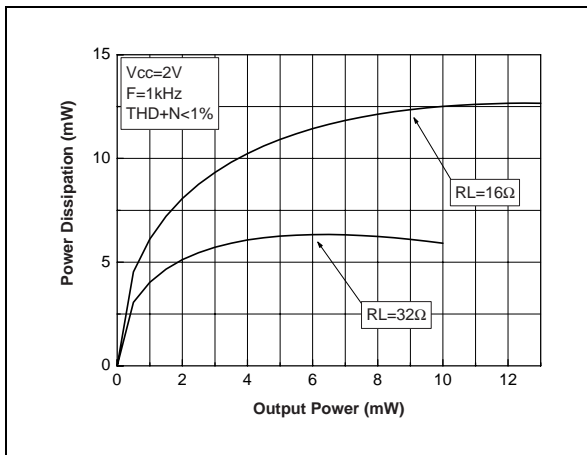

Fig. 28: Power Derating vs Ambient Temperature

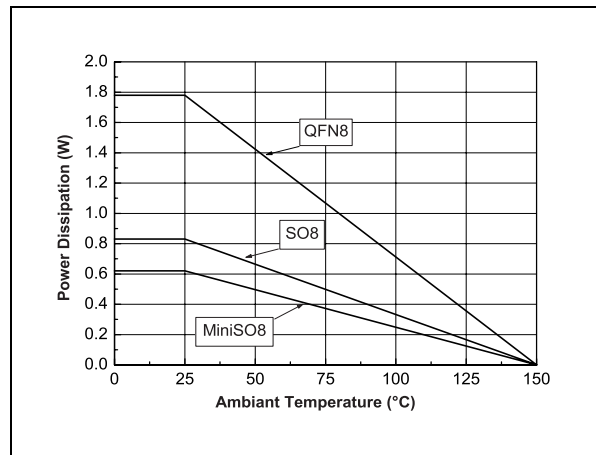

Fig. 29: Output Voltage Swing vs Power Supply Voltage

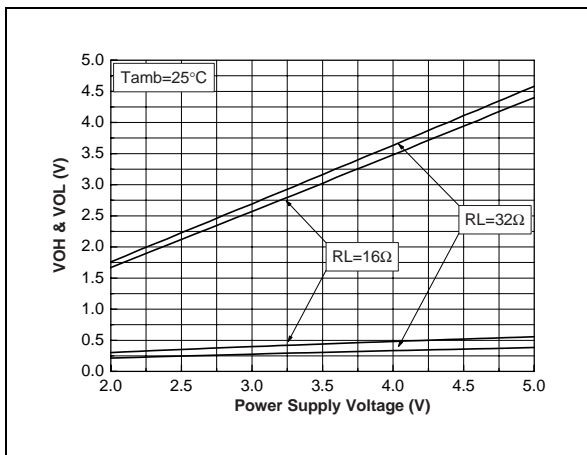

Fig. 30: Low Frequency Cut Off vs Input Capacitor for fixed gain versions.

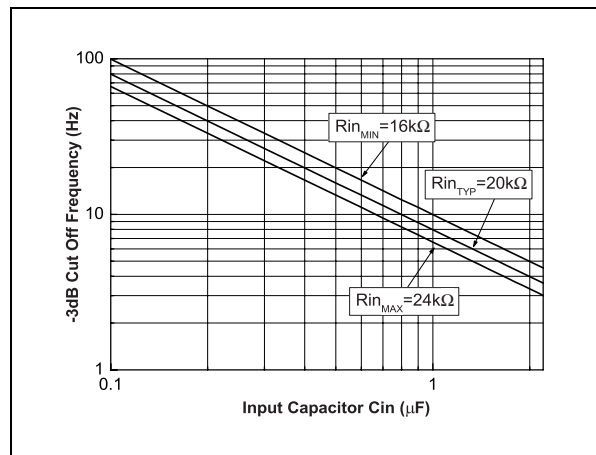

Fig. 31: THD + N vs Output Power

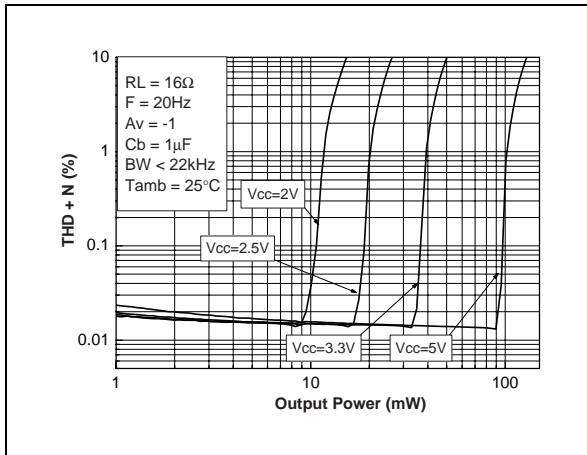

Fig. 32: THD + N vs Output Power

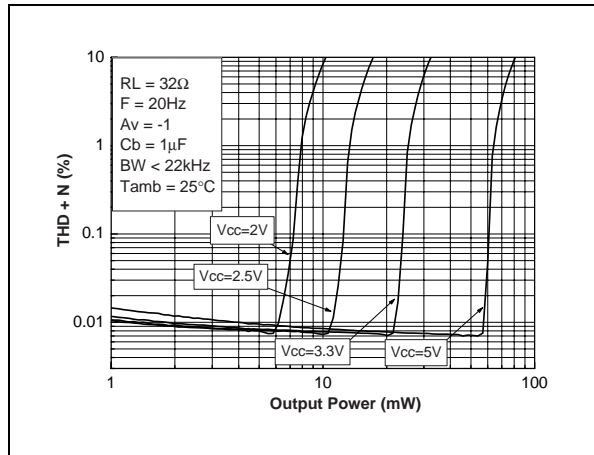

Fig. 33: THD + N vs Output Power

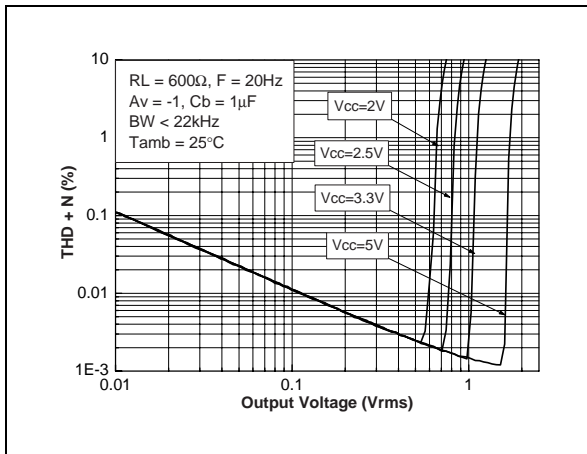

Fig. 34: THD + N vs Output Power

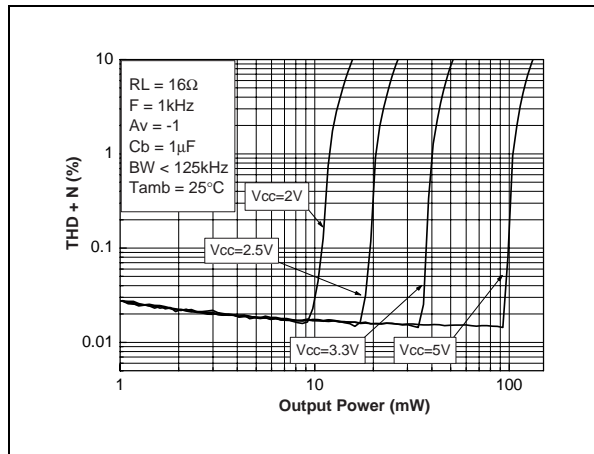

Fig. 35: THD + N vs Output Power

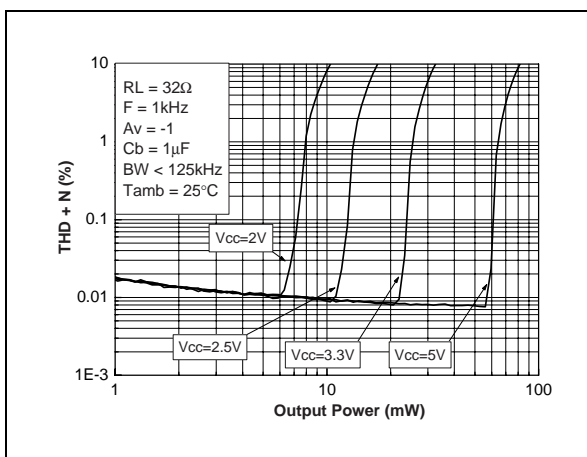

Fig. 36: THD + N vs Output Power

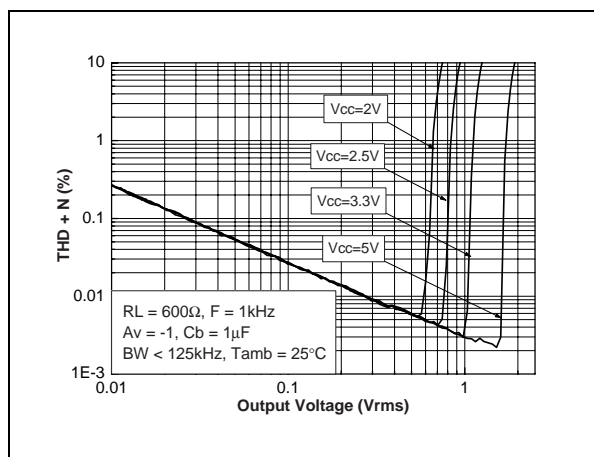

Fig. 37: THD + N vs Output Power

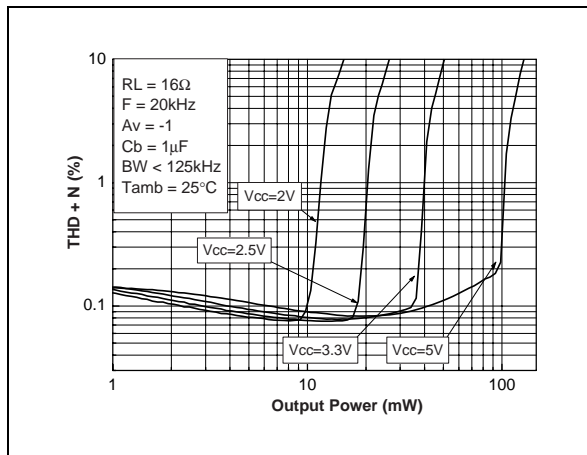

Fig. 38: THD + N vs Output Power

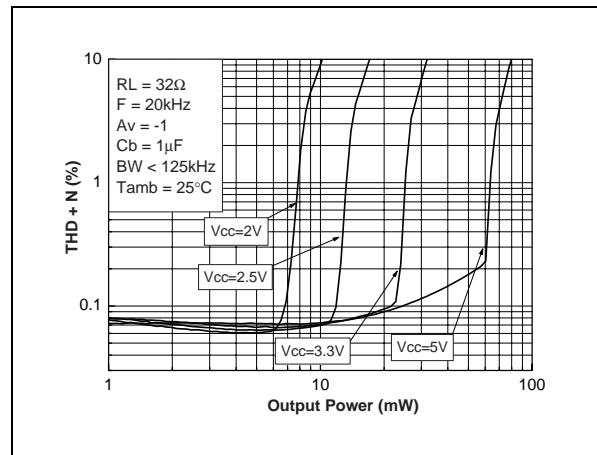

Fig. 39: THD + N vs Output Power

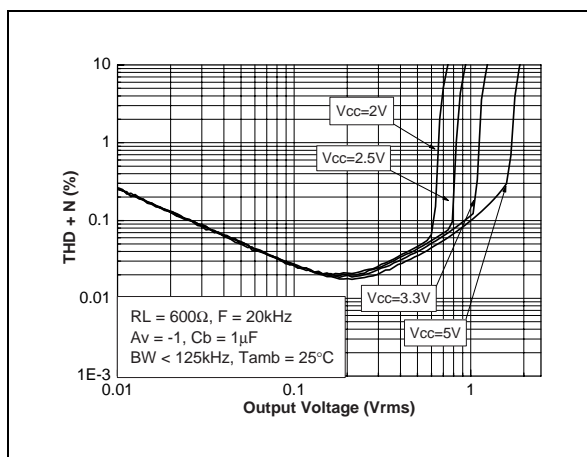

Fig. 40: THD + N vs Frequency

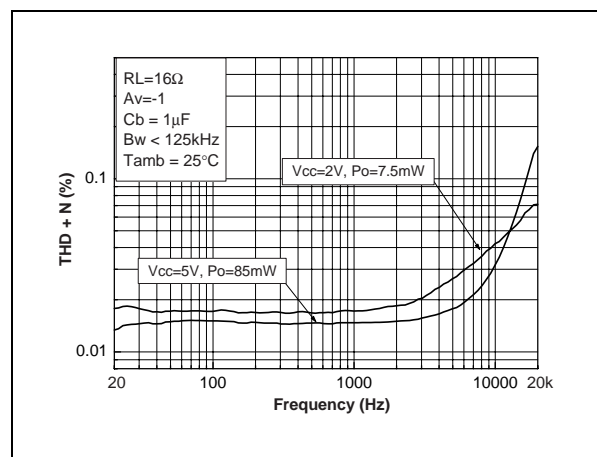

Fig. 41: THD + N vs Frequency

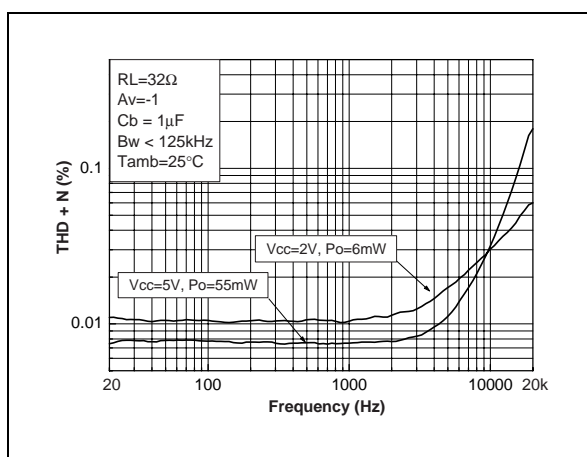

Fig. 42: THD + N vs Frequency

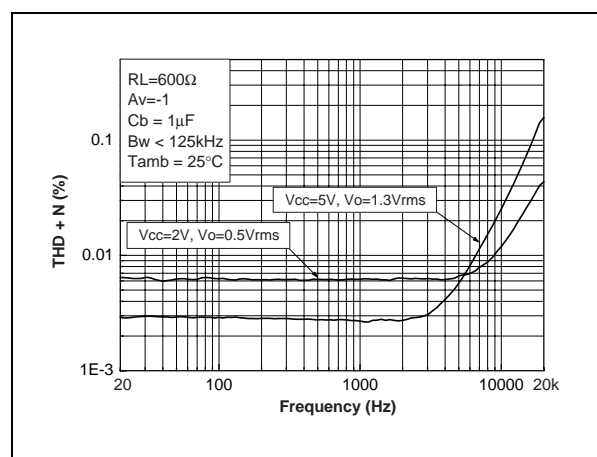

Fig. 43: Crosstalk vs Frequency

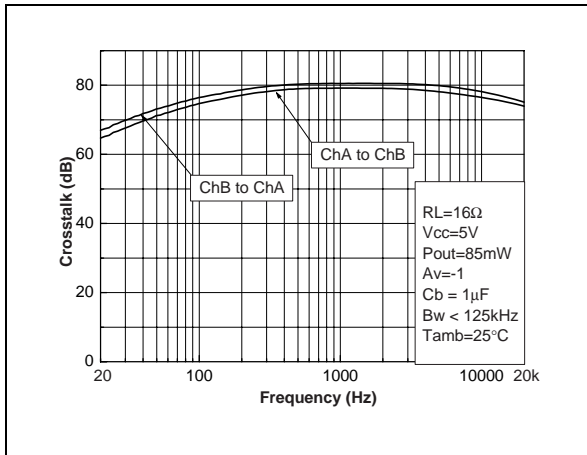

Fig. 44: Crosstalk vs Frequency

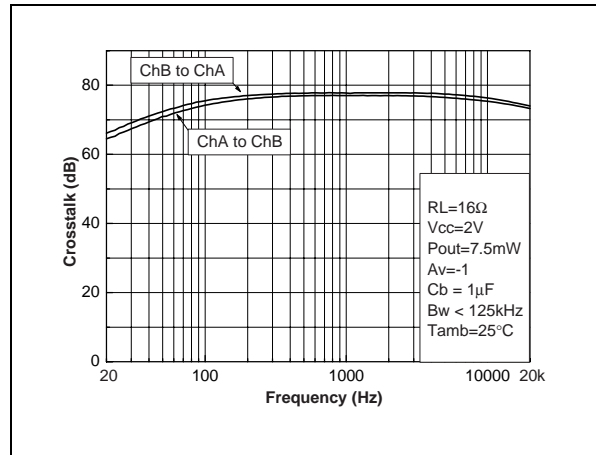

Fig. 45: Crosstalk vs Frequency

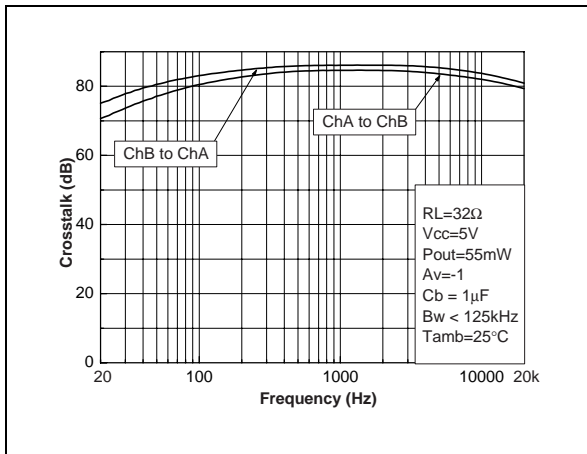

Fig. 46: Crosstalk vs Frequency

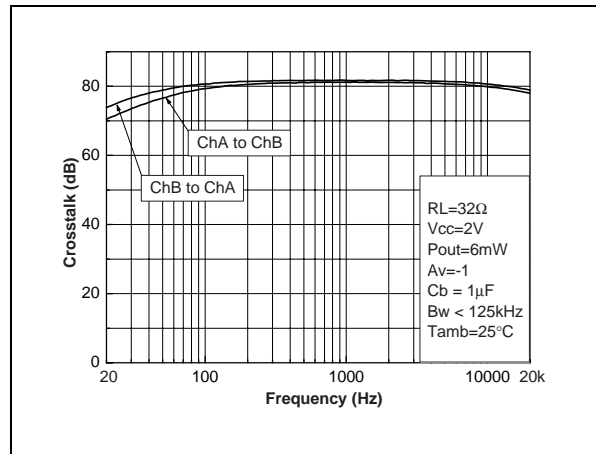

Fig. 47: Crosstalk vs Frequency

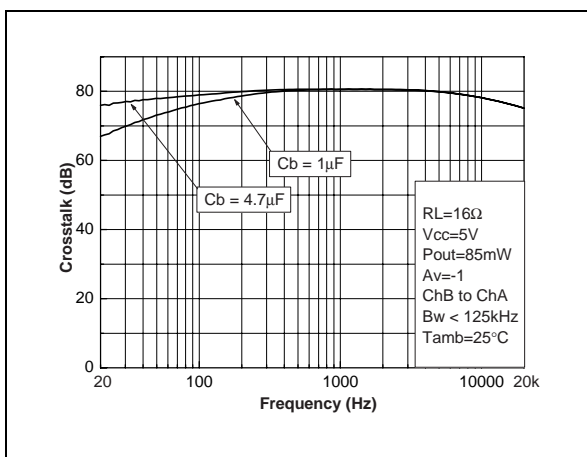
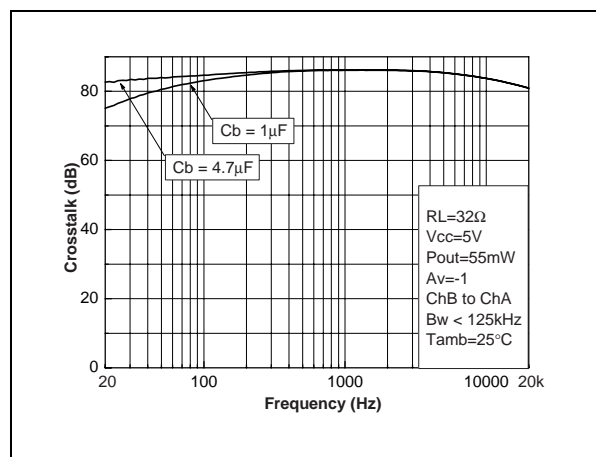
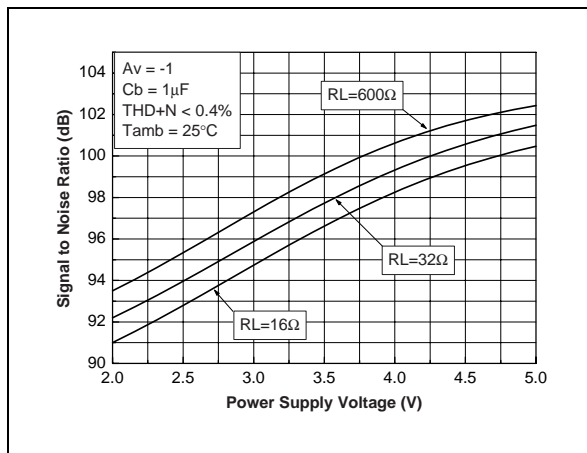

Fig. 48: Crosstalk vs Frequency

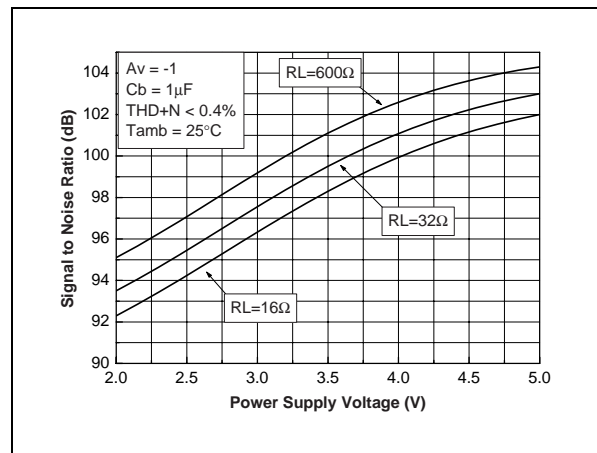



**Fig. 49: Signal to Noise Ratio vs Power Supply Voltage with Unweighted Filter (20Hz to 20kHz)**



**Fig. 50: Signal to Noise Ratio vs Power Supply Voltage with Weighted Filter Type A**



**Fig. 51: PSRR vs Power Supply Voltage**

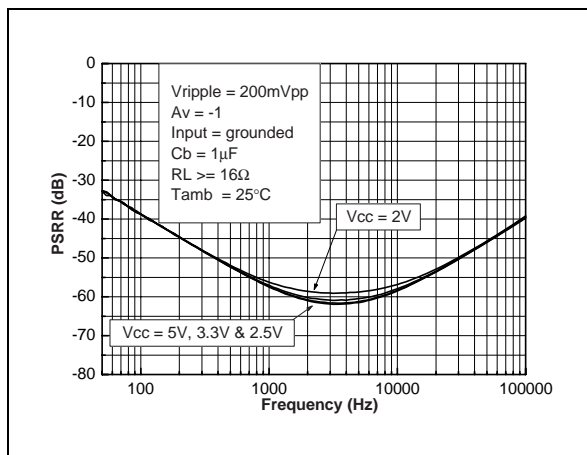

**Fig. 52: PSRR vs Bypass Capacitor**

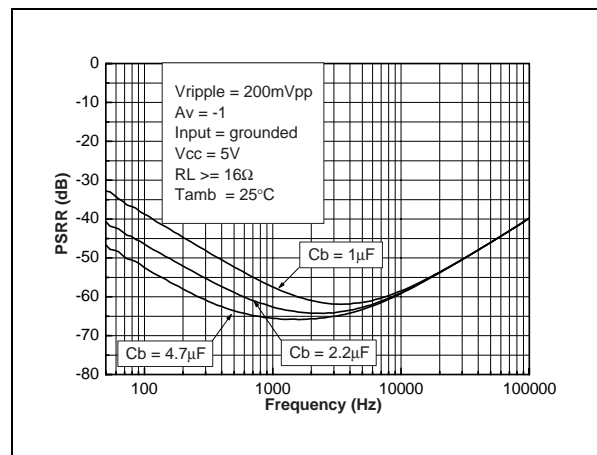

**Fig. 53: PSRR vs Input Capacitor**

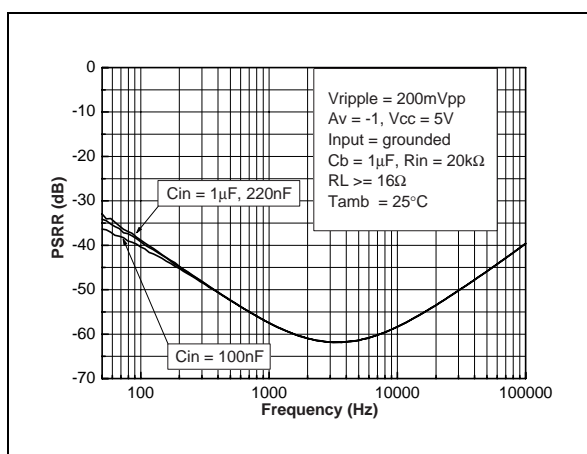

**Fig. 54: PSRR vs Output Capacitor**

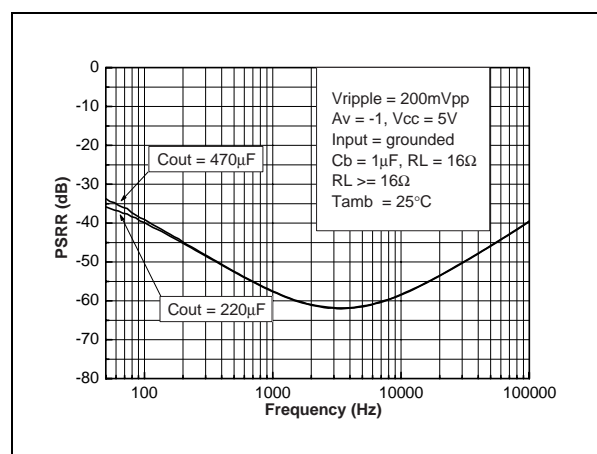

Fig. 55: PSRR vs Output Capacitor

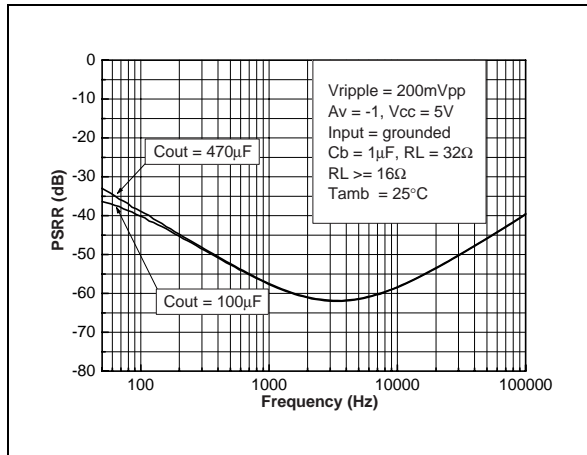

Fig. 56: PSRR vs Power Supply Voltage

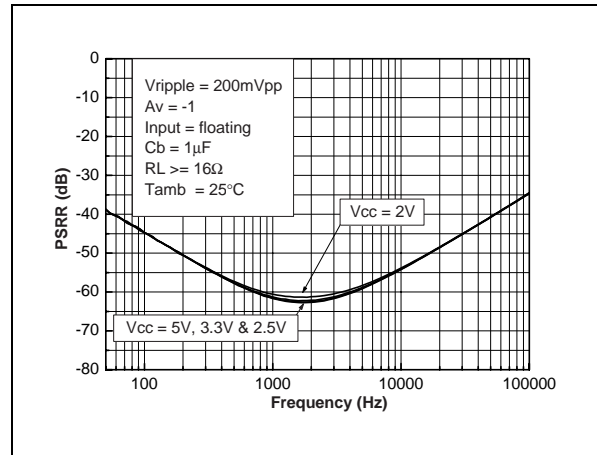

Fig. 57: THD + N vs Output Power

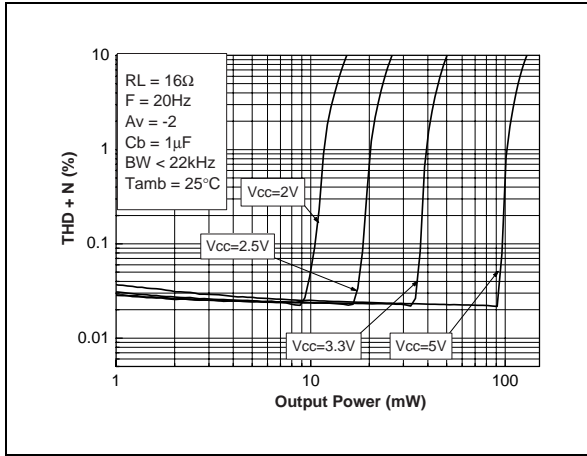

Fig. 58: THD + N vs Output Power

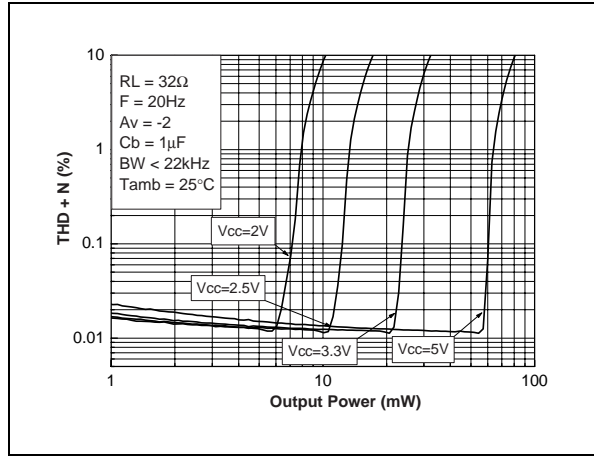

Fig. 59: THD + N vs Output Power

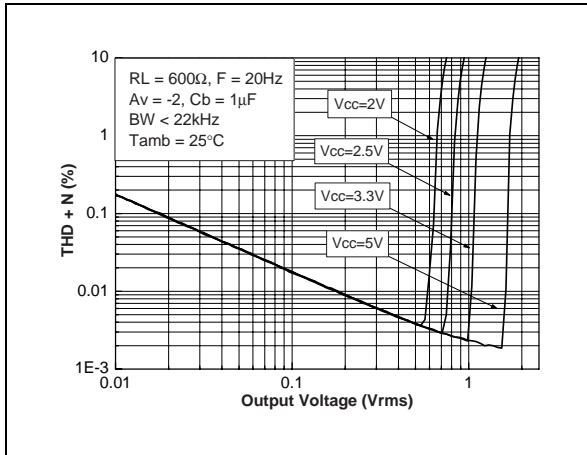

Fig. 60: THD + N vs Output Power

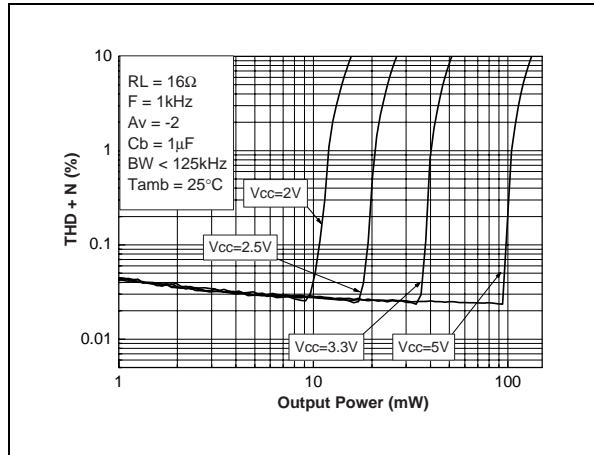

Fig. 61: THD + N vs Output Power

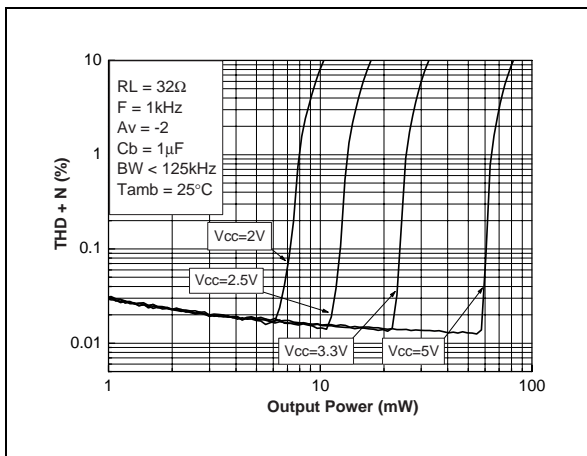

Fig. 62: THD + N vs Output Power

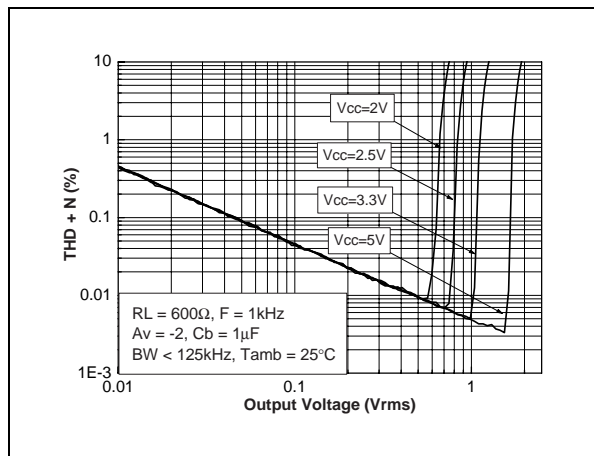

Fig. 63: THD + N vs Output Power

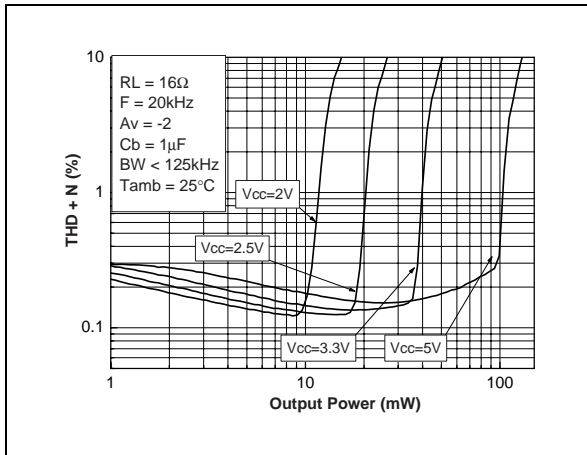

Fig. 64: THD + N vs Output Power

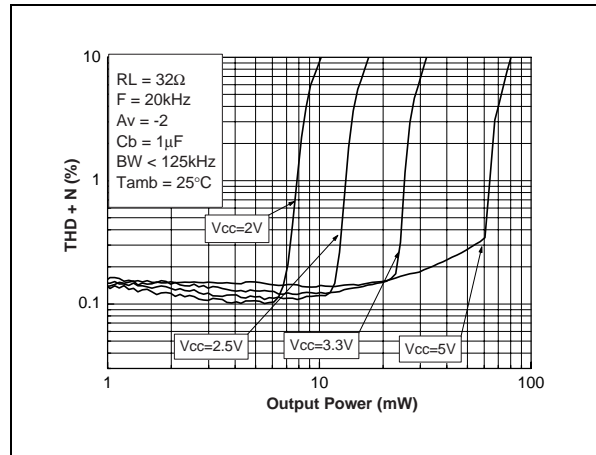

Fig. 65: THD + N vs Output Power

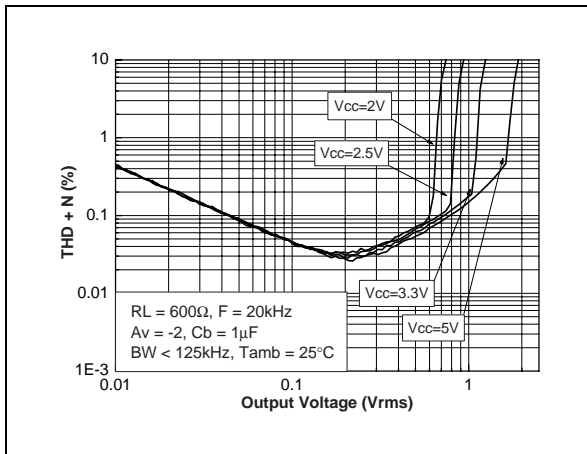

Fig. 66: THD + N vs Frequency

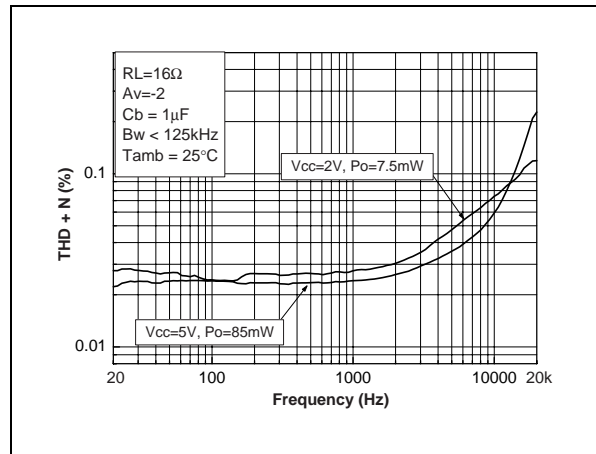

Fig. 67: THD + N vs Frequency

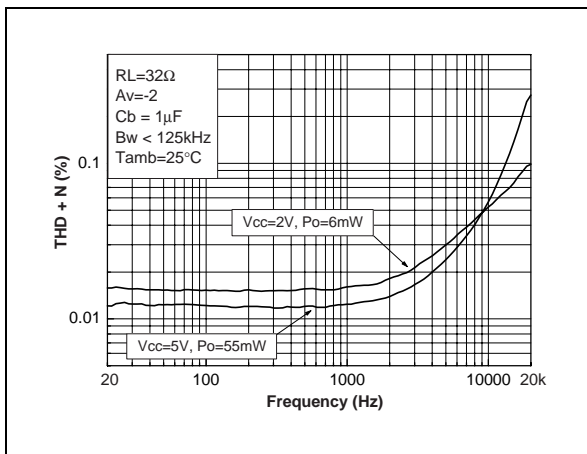

Fig. 68: THD + N vs Frequency

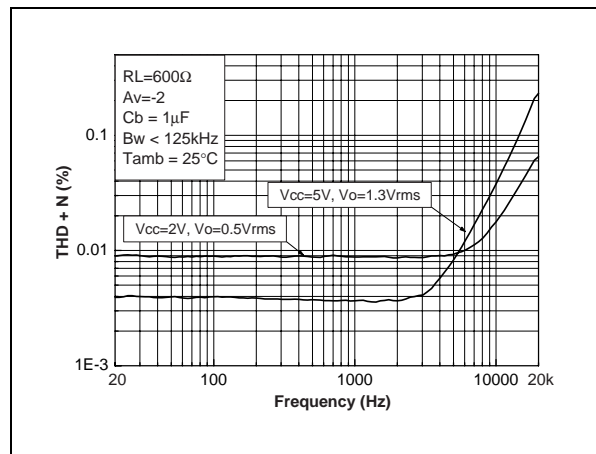

Fig. 69: Crosstalk vs Frequency

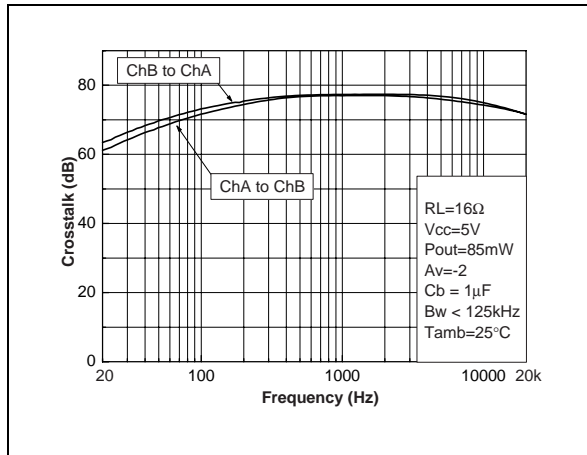

Fig. 70: Crosstalk vs Frequency

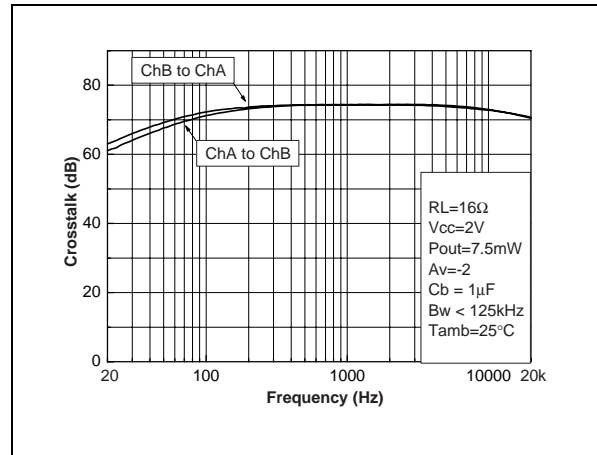

Fig. 71: Crosstalk vs Frequency

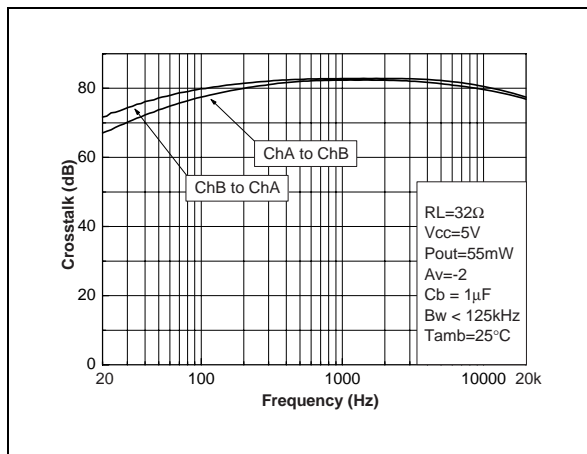

Fig. 72: Crosstalk vs Frequency

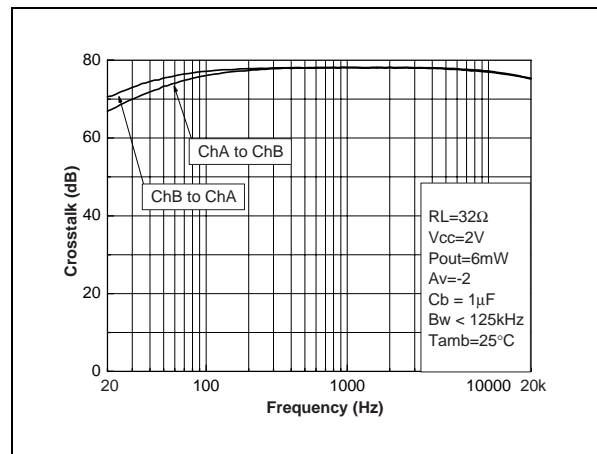

Fig. 73: Signal to Noise Ratio vs Power Supply Voltage with Unweighted Filter (20Hz to 20kHz)

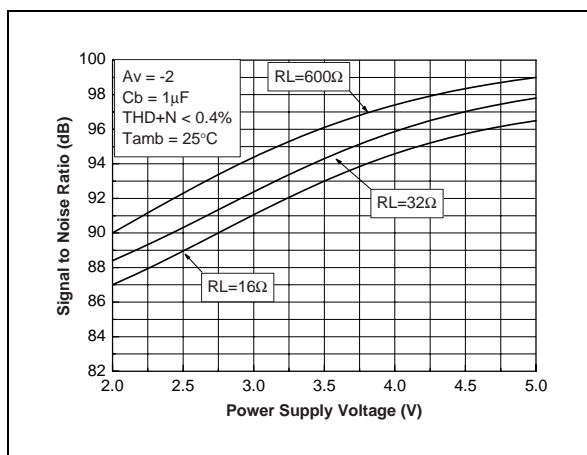

Fig. 74: Signal to Noise Ratio vs Power Supply Voltage with Weighted Filter Type A

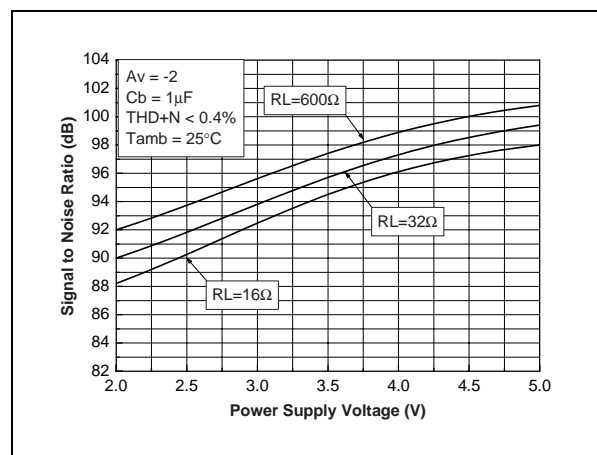

Fig. 75: PSRR vs Power Supply Voltage

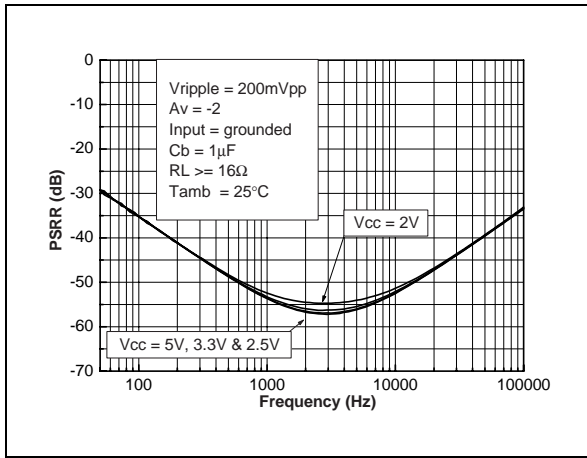

Fig. 76: PSRR vs Bypass Capacitor

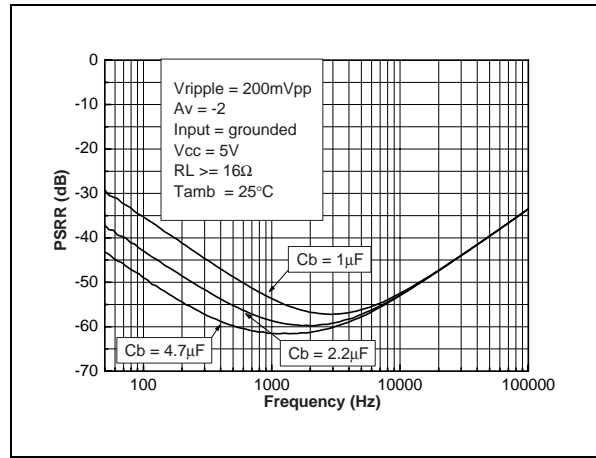

Fig. 77: PSRR vs Input Capacitor

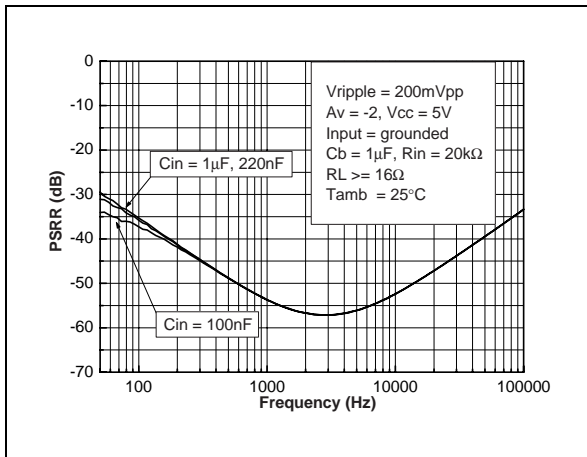

Fig. 78: PSRR vs Output Capacitor

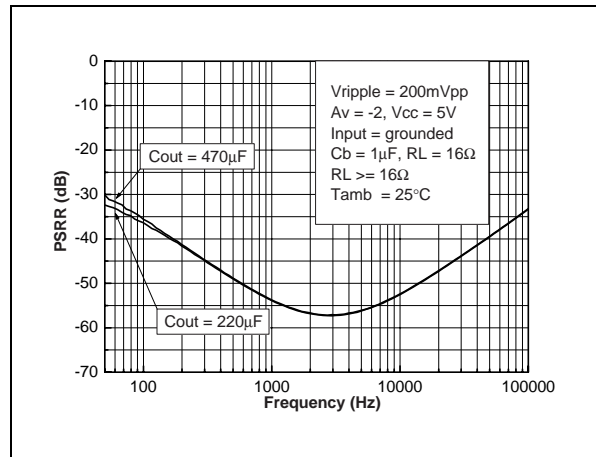

Fig. 79: PSRR vs Output Capacitor

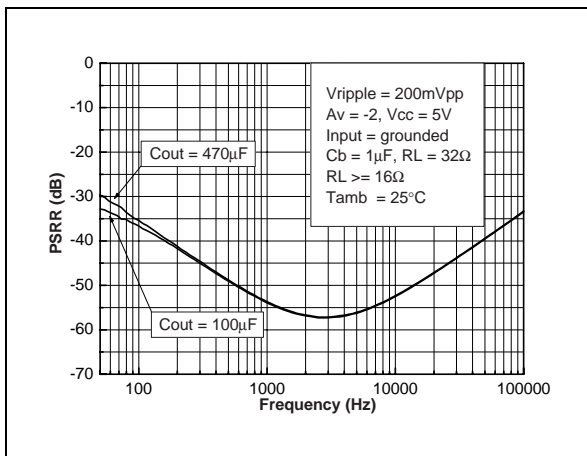

Fig. 80: THD + N vs Output Power

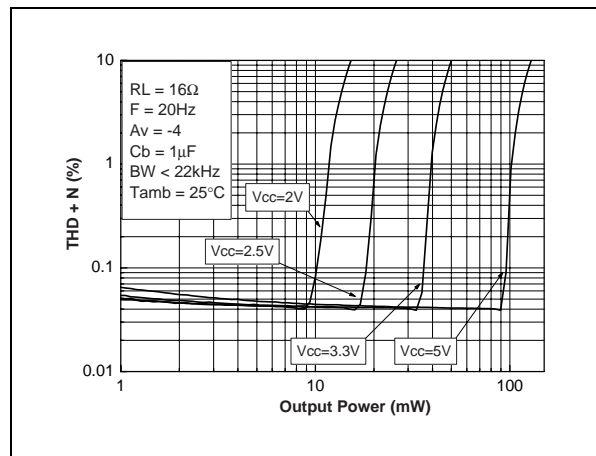

Fig. 81: THD + N vs Output Power

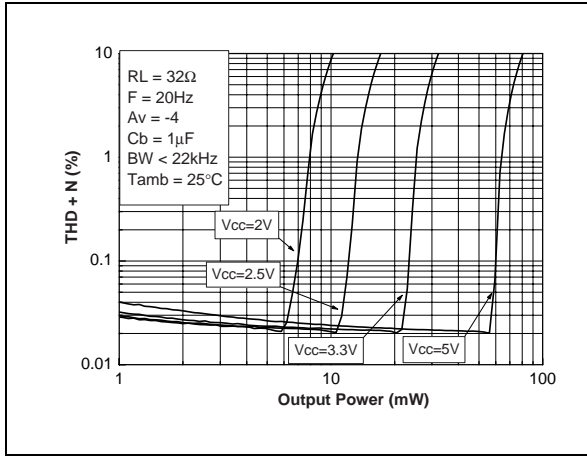

Fig. 82: THD + N vs Output Power

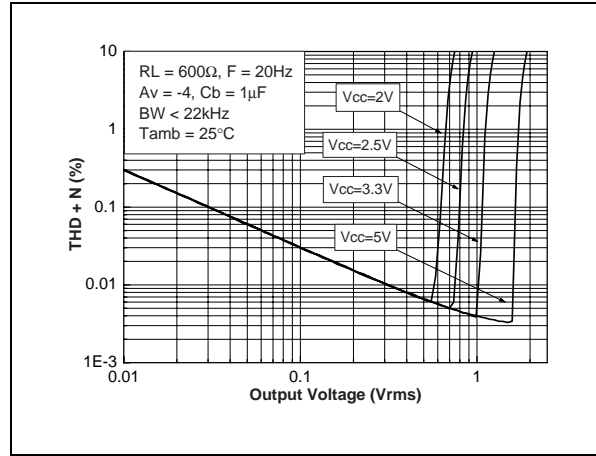

Fig. 83: THD + N vs Output Power

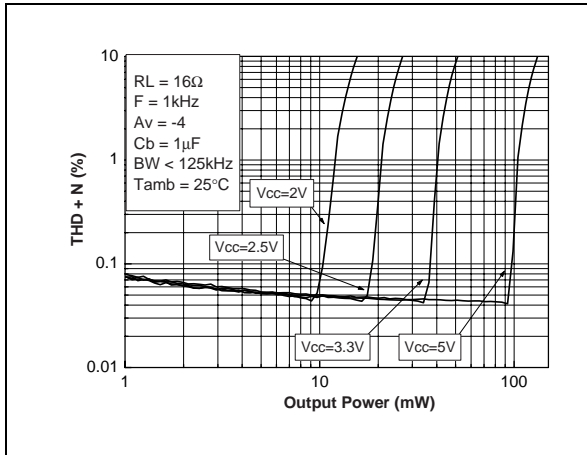

Fig. 84: THD + N vs Output Power

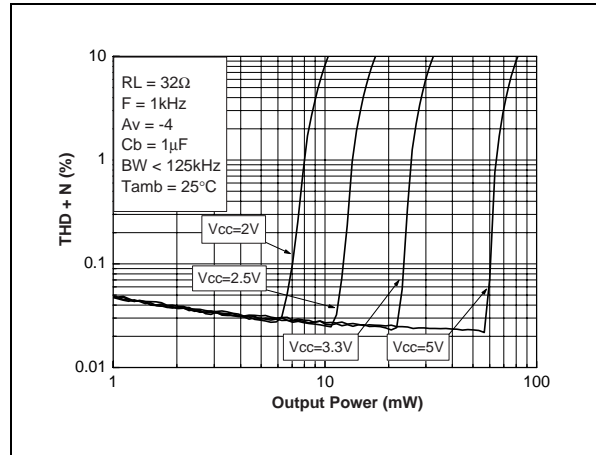

Fig. 85: THD + N vs Output Power

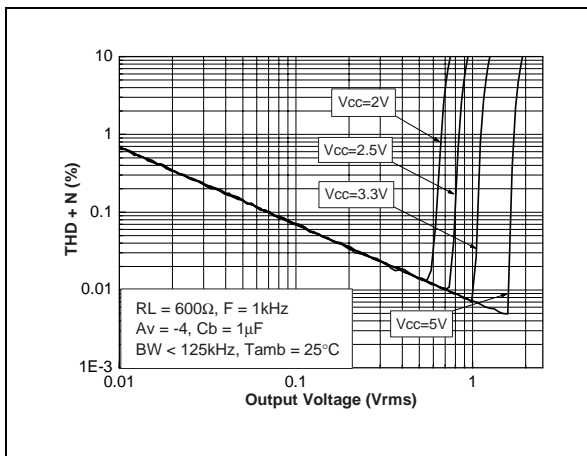

Fig. 86: THD + N vs Output Power

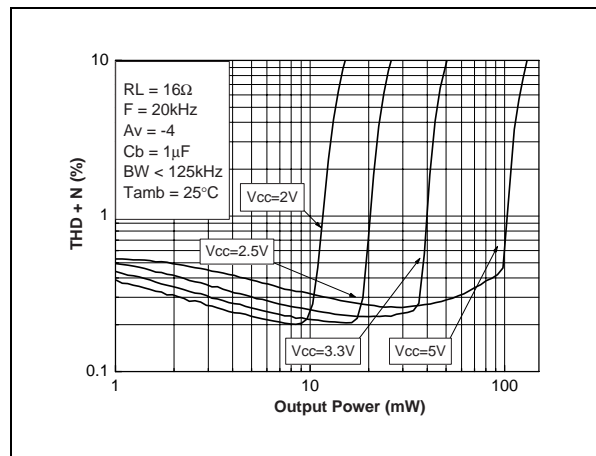

Fig. 87: THD + N vs Output Power

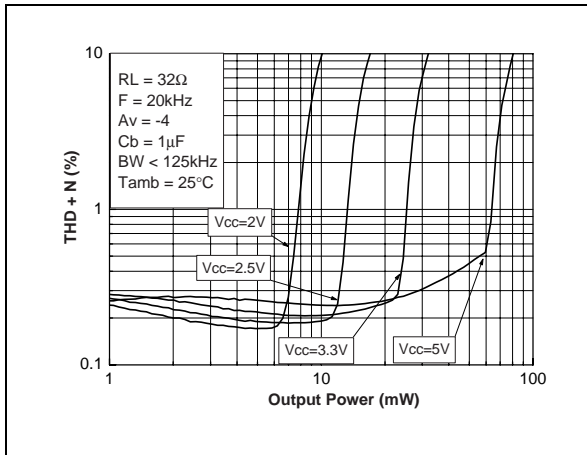

Fig. 88: THD + N vs Output Power

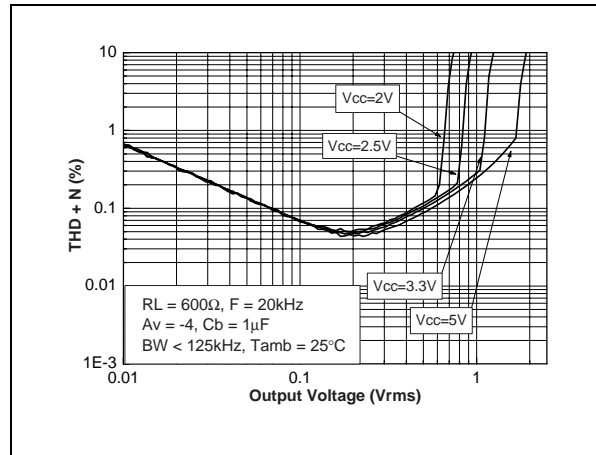

Fig. 89: THD + N vs Frequency

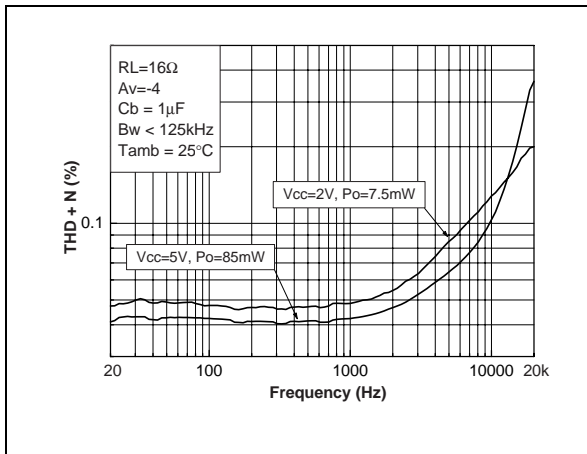

Fig. 90: THD + N vs Frequency

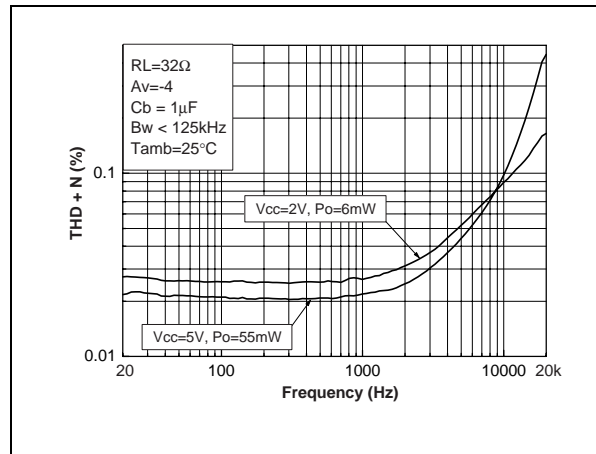

Fig. 91: THD + N vs Frequency

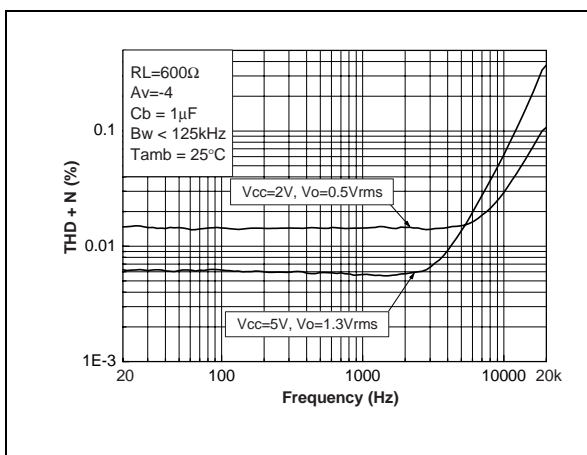

Fig. 92: Crosstalk vs Frequency

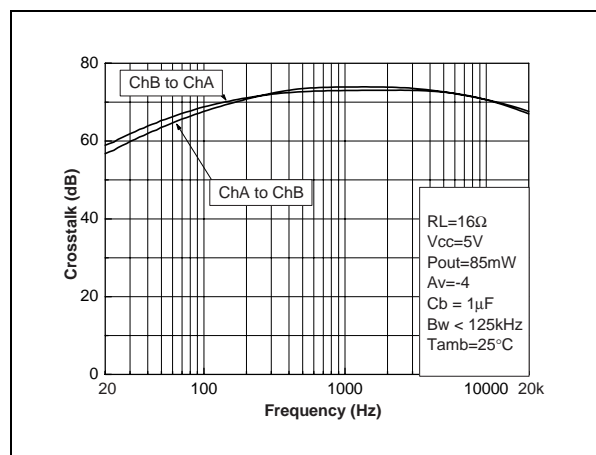



Fig. 93: Crosstalk vs Frequency

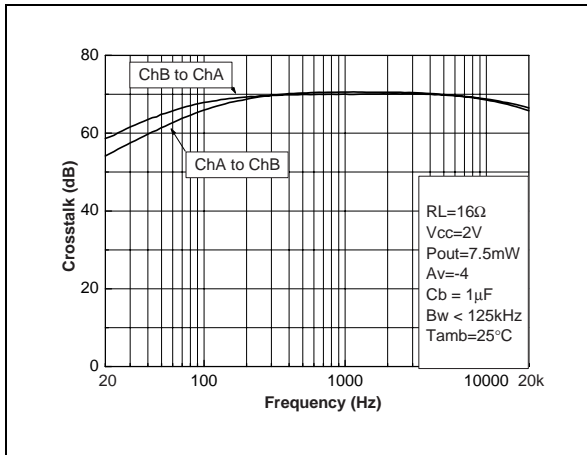

Fig. 94: Crosstalk vs Frequency

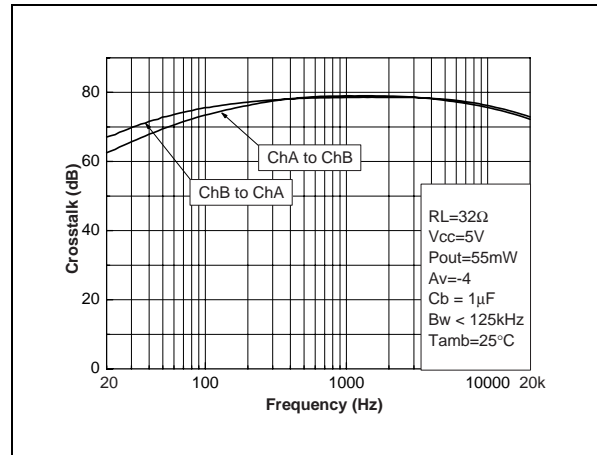

Fig. 95: Crosstalk vs Frequency

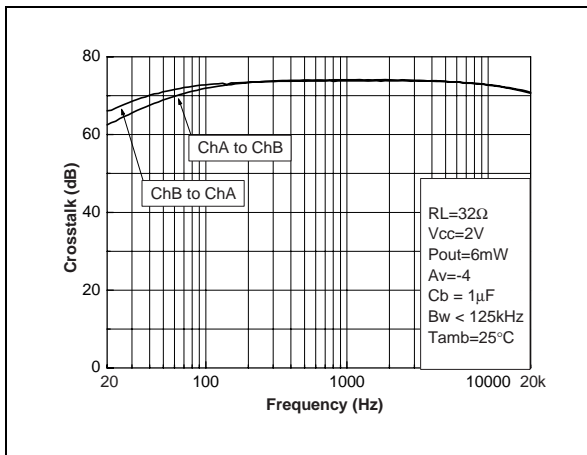

Fig. 96: Signal to Noise Ratio vs Power Supply Voltage with Unweighted Filter (20Hz to 20kHz)

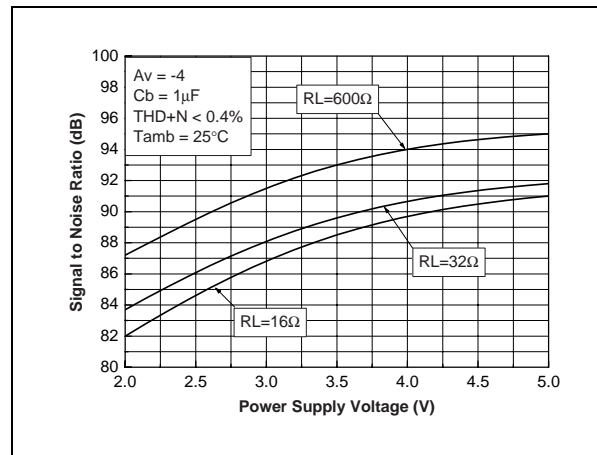

Fig. 97: Signal to Noise Ratio vs Power Supply Voltage with Weighted Filter Type A

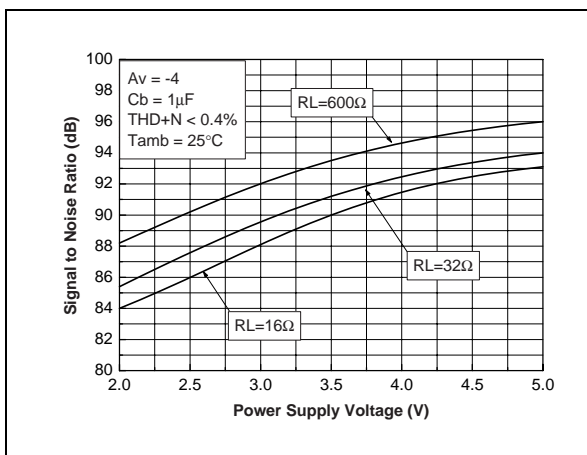

Fig. 98: PSRR vs Power Supply Voltage

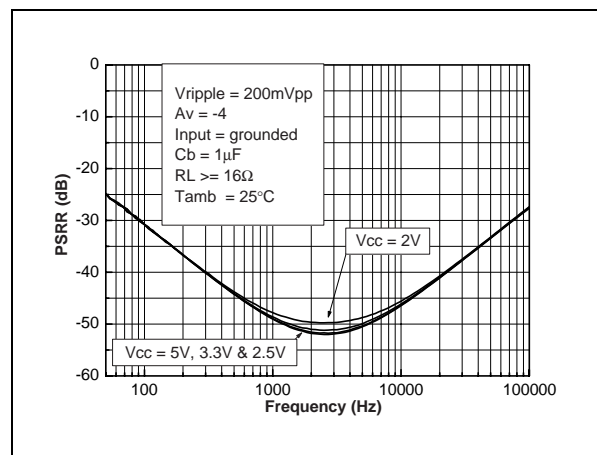

Fig. 99: PSRR vs Input Capacitor

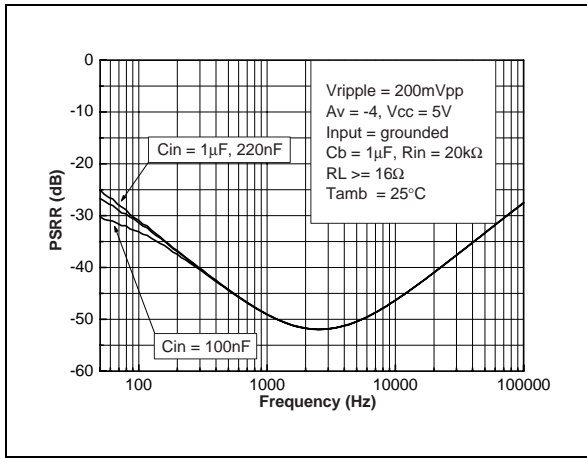

Fig. 100: PSRR vs Bypass Capacitor

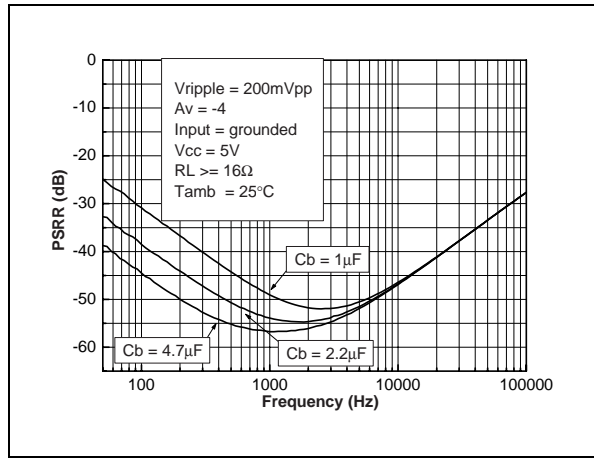

Fig. 101: PSRR vs Output Capacitor

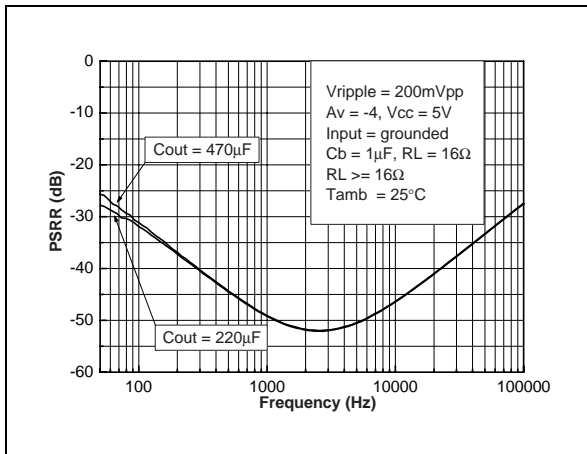
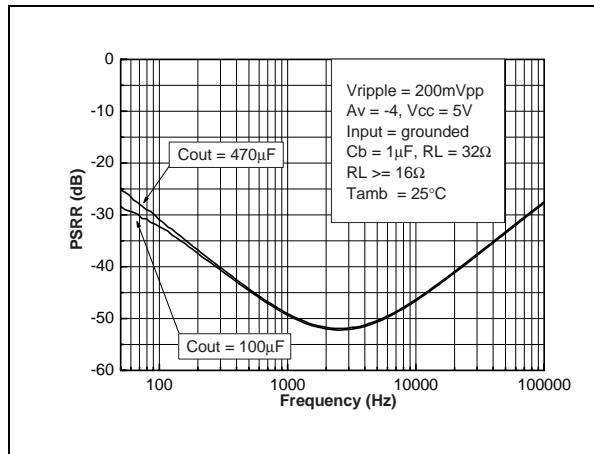
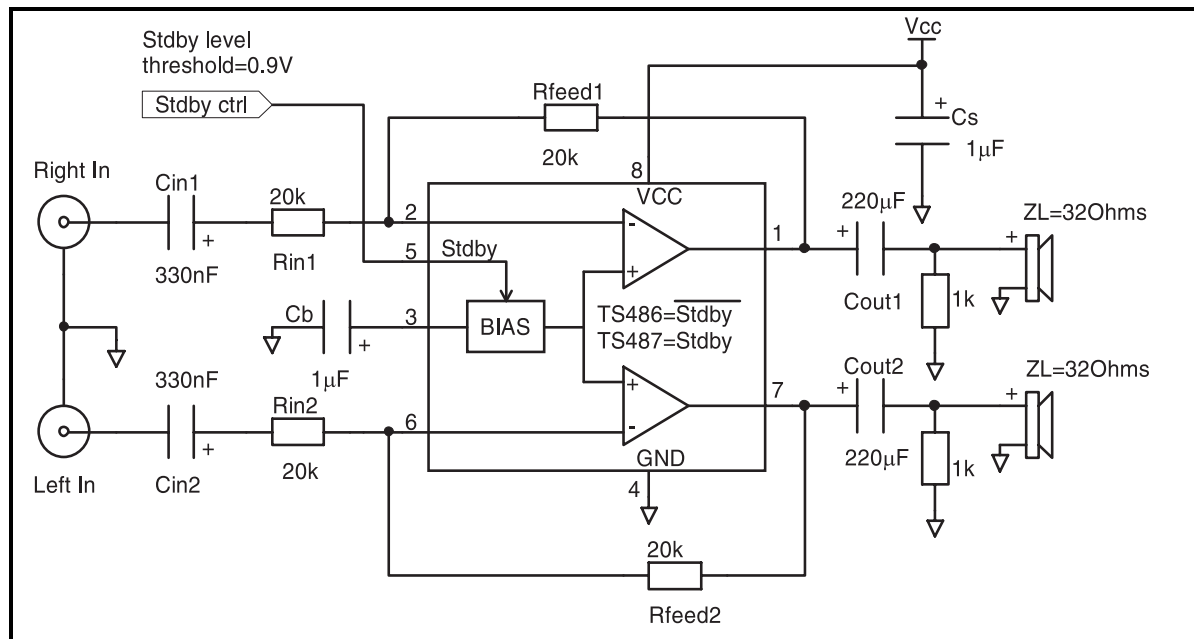

Fig. 102: PSRR vs Output Capacitor



**APPLICATION NOTE:**



**TS486/487 GENERAL DESCRIPTION**

TS486/487 is a family of dual audio amplifiers able to drive 16Ω or 32Ω headsets. Working in the 2V to 5.5V supply voltage range, they deliver 100mW at 5V and 12mW at 2V in a 16Ω load. An internal output current limitation, offers protection against short-circuits at the output over a limited time period.

Fixed gain versions of the TS486 and TS487 including the feedback resistor and the input resistors are also proposed to reduce the number of external parts.

The TS486 and TS487 exhibit a low quiescent current of typically 1.8mA, allowing usage in portable applications.

The standby mode is selected using the SHUTDOWN input. For TS486 (respectively TS487), the device is in sleep mode when PIN 5 is connected at GND (resp. VCC).

**GAIN SETTING**

The gain of each inverter amplifier of the TS486 and TS487 is set by the resistors R<sub>IN</sub> and R<sub>FEED</sub>.

$$\text{Gain}_{\text{LINEAR}} = -(R_{\text{FEED}}/R_{\text{IN}})$$

$$\text{Gain}_{\text{dB}} = 20 \text{ Log}(R_{\text{FEED}}/R_{\text{IN}})$$

Fixed gain versions TS486-n and TS487-n including R<sub>IN</sub> and R<sub>FEED</sub> are proposed to reduce external parts.

**LOW FREQUENCY ROLL-OFF WITH INPUT CAPACITORS**

The low roll-off frequency of the headphone amplifiers depends on the input capacitors C<sub>IN1</sub> and C<sub>IN2</sub> and the input resistors R<sub>IN1</sub> and R<sub>IN2</sub>.

The C<sub>IN</sub> capacitor in series with the input resistor R<sub>IN</sub> of the amplifier is equivalent to a first order high pass filter.

Assuming that F<sub>min</sub> is the lowest frequency to be amplified (with a 3dB attenuation), the minimum value of C<sub>IN</sub> is:

$$C_{\text{IN}} > 1 / (2 * \pi * F_{\text{min}} * R_{\text{IN}})$$

The following curve gives directly the low frequency roll-off versus the input capacitor C<sub>IN</sub>

and for various values of the input resistor  $R_{IN}$ .

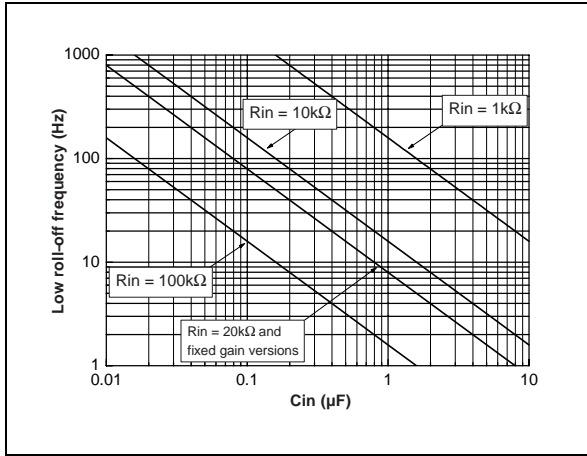

The input resistance of the fixed gain version is typically  $20k\Omega$ .

The following curve shows the limits of the roll off frequency depending on the min. and max. values of  $R_{in}$ :

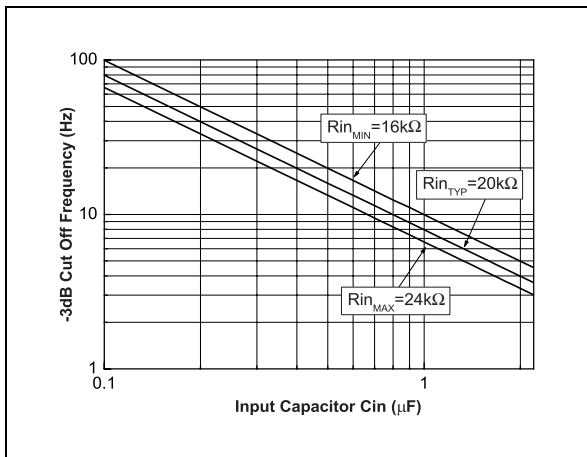

**LOW FREQUENCY ROLL OFF WITH OUTPUT CAPACITORS**

The DC voltage on the outputs of the TS486/487 is blocked by the output capacitors  $C_{OUT1}$  and  $C_{OUT2}$ . Each output capacitor  $C_{OUT}$  in series with the resistance of the load  $R_L$  is equivalent to a first order high pass filter.

Assuming that  $F_{min}$  is the lowest frequency to be amplified (with a 3dB attenuation), the minimum value of  $C_{OUT}$  is:

$$C_{OUT} > 1 / (2 * \pi * F_{min} * R_L)$$

The following curve gives directly the low roll-off

frequency versus the output capacitor  $C_{OUT}$  in  $\mu F$  and for the two typical  $16\Omega$  and  $32\Omega$  impedances:

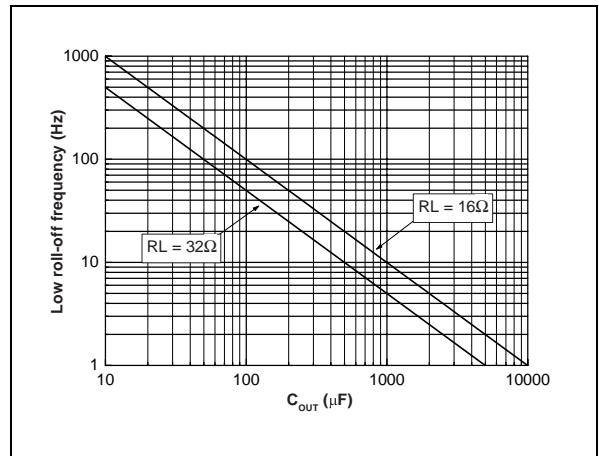

**DECOUPLING CAPACITOR  $C_B$**

The internal bias voltage at  $V_{cc}/2$  is decoupled with the external capacitor  $C_B$ .

The TS486 and TS487 have a specified Power Supply Rejection Ratio parameter with  $C_B = 1\mu F$ . A higher value of  $C_B$  improves the PSRR, for example, a  $4.7\mu F$  improves the PSRR by 15dB at 200Hz (please, refer to fig. 76 "PSRR vs Bypass Capacitor").

**POP PRECAUTIONS**

Generally headphones are connected using a connector as a jack. To prevent a pop in the headphones when plugged in the jack, a resistor should be connected in parallel with each headphone output. This allows the capacitors  $C_{out}$  to be charged even when no headphone is plugged.

A resistor of  $1k\Omega$  is high enough to be a negligible load, and low enough to charge the capacitors  $C_{out}$  in less than one second.



PACKAGE MECHANICAL DATA

**SO-8 MECHANICAL DATA**

DIM.	mm.			inch		
	MIN.	TYP.	MAX.	MIN.	TYP.	MAX.
A	1.35		1.75	0.053		0.069
A1	0.10		0.25	0.04		0.010
A2	1.10		1.65	0.043		0.065
B	0.33		0.51	0.013		0.020
C	0.19		0.25	0.007		0.010
D	4.80		5.00	0.189		0.197
E	3.80		4.00	0.150		0.157
e		1.27			0.050	
H	5.80		6.20	0.228		0.244
h	0.25		0.50	0.010		0.020
L	0.40		1.27	0.016		0.050
k	8° (max.)					
ddd			0.1			0.04

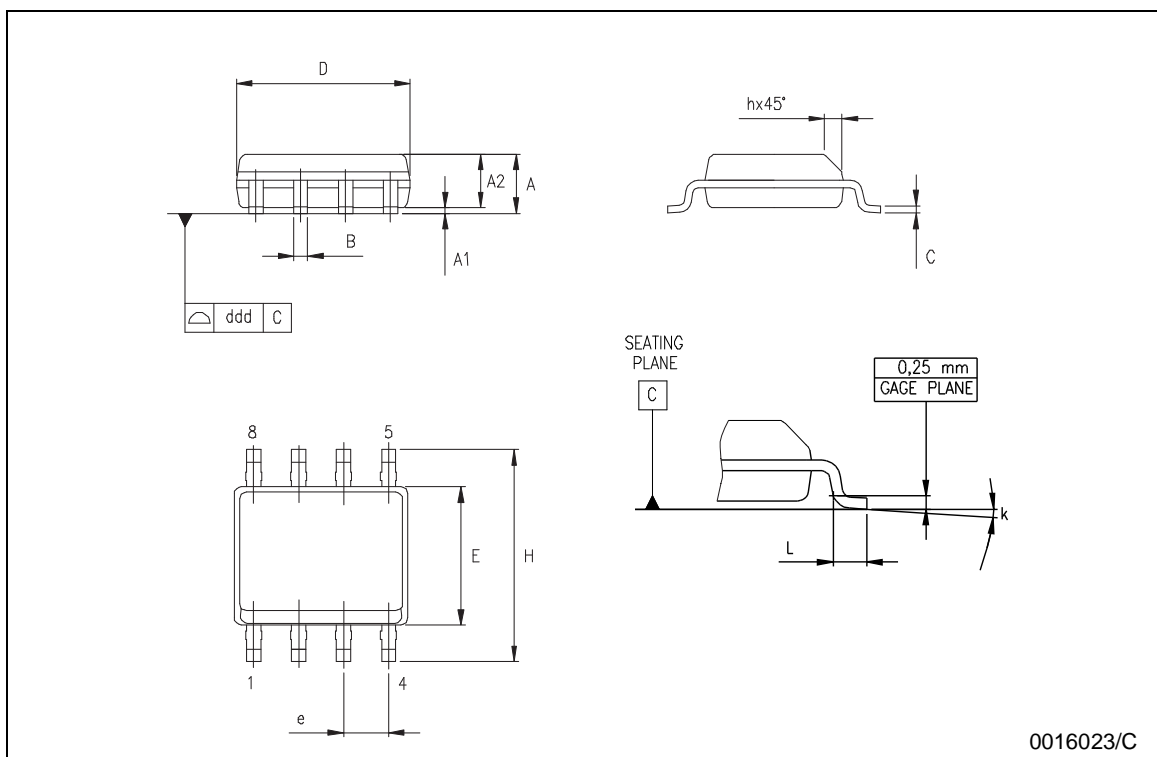

**PACKAGE MECHANICAL DATA**

DIM.	mm.			inch		
	MIN.	TYP	MAX.	MIN.	TYP.	MAX.
A			1.1			0.043
A1	0.05	0.10	0.15	0.002	0.004	0.006
A2	0.78	0.86	0.94	0.031	0.031	0.037
b	0.25	0.33	0.40	0.010	0.13	0.013
c	0.13	0.18	0.23	0.005	0.007	0.009
D	2.90	3.00	3.10	0.114	0.118	0.122
E	4.75	4.90	5.05	0.187	0.193	0.199
E1	2.90	3.00	3.10	.0114	0.118	0.122
e		0.65			0.026	
K	0°		6°	0°		6°
L	0.40	0.55	0.70	0.016	0.022	0.028
L1			0.10			0.004

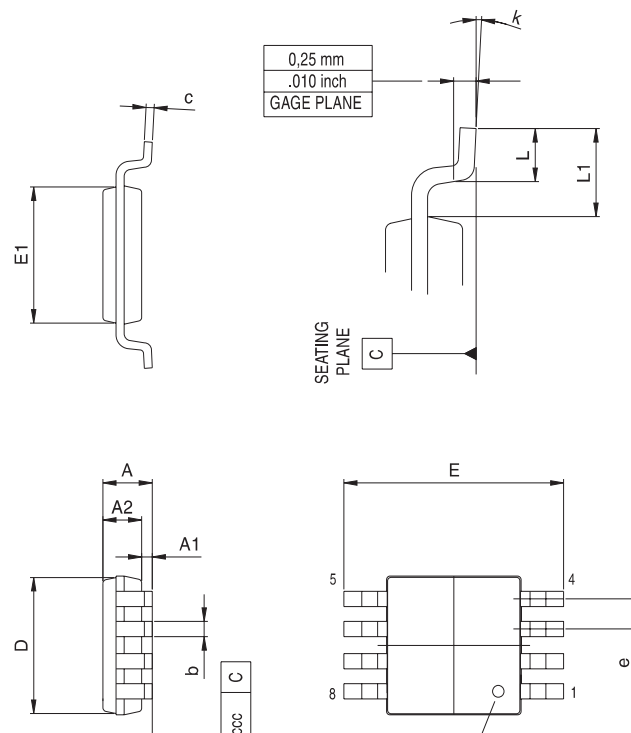

PACKAGE MECHANICAL DATA

DFN8 (3x3) MECHANICAL DATA

DIM.	mm.			inch		
	MIN.	TYP	MAX.	MIN.	TYP.	MAX.
A	0.80	0.90	1.00	31,5	35,4	39,4
A1		0.02	0.05		0.8	2.0
A2		0.70			27,6	
A3		0.20			7.9	
b	0.18	0.23	0.30	7.1	9.1	11.8
D		3.00			118,1	
D2	2.23	2.38	2.48	87.8	93.7	97.7
E		3.00			118,1	
E2	1.49	1.64	1.74	58.7	64.6	68.5
e		0.50			19.7	
L	0.30	0.40	0.50	11.8	15.7	19.7

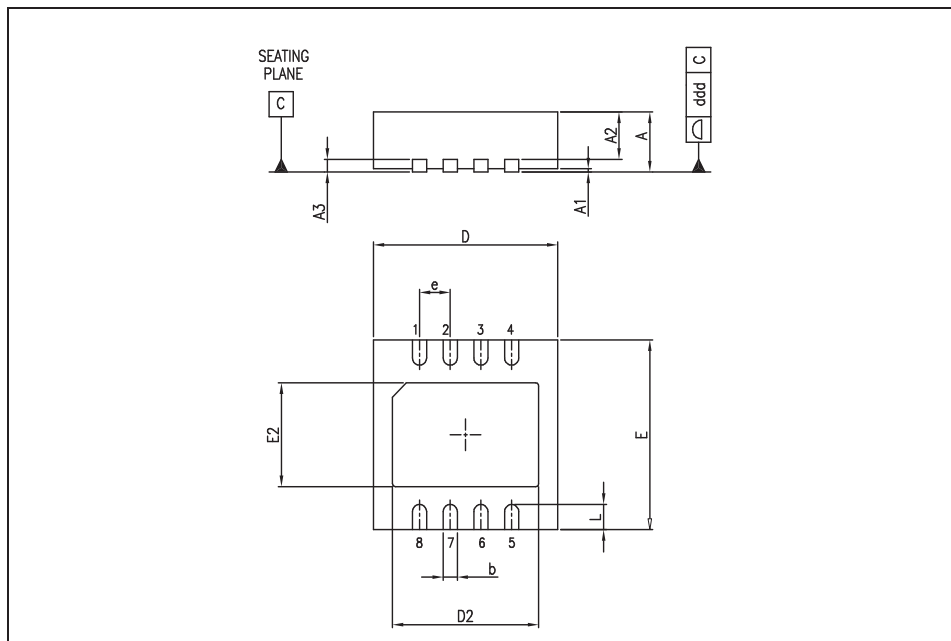

Information furnished is believed to be accurate and reliable. However, STMicroelectronics assumes no responsibility for the consequences of use of such information nor for any infringement of patents or other rights of third parties which may result from its use. No license is granted by implication or otherwise under any patent or patent rights of STMicroelectronics. Specifications mentioned in this publication are subject to change without notice. This publication supersedes and replaces all information previously supplied. STMicroelectronics products are not authorized for use as critical components in life support devices or systems without express written approval of STMicroelectronics.

The ST logo is a registered trademark of STMicroelectronics

© 2003 STMicroelectronics - All Rights Reserved  
 STMicroelectronics GROUP OF COMPANIES

Australia - Brazil - China - Finland - France - Germany - Hong Kong - India - Italy - Japan - Malaysia - Malta - Morocco  
 Singapore - Spain - Sweden - Switzerland - United Kingdom  
<http://www.st.com>

