

### FEATURES

- RoHS compliant
- Efficiency from 60.5%
- Wide temperature performance -40°C to 85°C
- UL 94V-0 Package material
- Lead frame technology
- 5V, 12V, & 24V Input
- 5V, 12V & 15V Output
- Internal SMD construction
- 1kVDC Isolation
- MTTF up to 1.4 million hours
- Power density 0.7W/cm<sup>3</sup>
- Multi layer ceramic capacitors

### PRODUCT DESCRIPTION

The NTF 1W series of surface mount DC/DC converters offer a tightly regulated output voltage in a true surface mount device, available with three 2:1 input voltage ranges of 4-6V, 9-15V and 18-36V. The NTF series' employs leadframe technology and transfer moulding techniques to bring all of the benefits of IC style packaging to hybrid circuitry. Co-planarity of the lead positions is based upon IEC 191-6:1990. The devices are suitable for all applications where high volume production is envisaged.

### SELECTION GUIDE

Order Code	Input Voltage	Output Voltage	Output Current	Input Current			Efficiency		MTTF	
	Nominal			100% Load	0% Load	Shutdown	100% Load	Min.		Typ.
	V			mA	mA	µA	mA	%		kHrs
NTFS0505MC	5	5	200	25	72	320	60.5	62	921	
NTFS0512MC	5	12	83	30	55	300	63.5	67	1118	
NTFS0515MC	5	15	66	60	80	320	60.5	63	869	
NTFS1205MC	12	5	200	10	70	110	68.0	73	1281	
NTFS1212MC	12	12	83	12	34	130	65.0	66	1175	
NTFS1215MC	12	15	66	15	33	120	65.0	67	1283	
NTFS2405MC	24	5	200	6	96	120	65.0	70	1379	
NTFS2412MC	24	12	83	8	48	60	65.0	68	1278	
NTFS2415MC	24	15	66	9	50	60	65.0	67	1223	

### INPUT CHARACTERISTICS

Parameter	Conditions	Min.	Typ.	Max.	Units
Voltage range	Continuous operation, 5V input types	4	5	6	V
	Continuous operation, 12V input types	9	12	15	
	Continuous operation, 24V input types	18	24	36	
Reflected ripple current	xx05 output types		12		mA p-p
	xx12 output types		6		
	xx24 output types		6		

### OUTPUT CHARACTERISTICS

Parameter	Conditions	Min.	Typ.	Max.	Units
Voltage set point accuracy	With external input/output capacitors		±1	±2	%
Line regulation	Low line to high line,		0.2	1	%
Load regulation	10% load to 100% load, with external input/output capacitors		0.1	1	%
Ripple & Noise	BW=DC to 20MHz, all output types		100	150	mV p-p
Voltage trim range		-10		+10	%V <sub>OUT</sub>

### GENERAL CHARACTERISTICS

Parameter	Conditions	Min.	Typ.	Max.	Units
Switching frequency		50		700	kHz

### ABSOLUTE MAXIMUM RATINGS

Short-circuit protection	15s
Lead temperature 1.5mm from case for 10 seconds	245°C
Minimum load	See graph
Input voltage V <sub>IN</sub> , NTF05 types	10V
Input voltage V <sub>IN</sub> , NTF12 types	17.5V
Input voltage V <sub>IN</sub> , NTF24 types	40V

<sup>1</sup> Calculated using MIL-HDBK-217F with nominal input voltage at full load (ground benign) at 25°C.  
All specifications typical at T<sub>A</sub>=25°C, nominal input voltage and rated output current unless otherwise specified.



For full details go to  
[www.murata-ps.com/rohs](http://www.murata-ps.com/rohs)

TEMPERATURE CHARACTERISTICS					
Parameter	Conditions	Min.	Typ.	Max.	Units
Operation	See derating graphs	-40		85	
Storage		-50		130	
Cooling	Free air convection				
Case temperature rise above ambient			30		°C

ISOLATION CHARACTERISTICS					
Parameter	Conditions	Min.	Typ.	Max.	Units
Isolation test voltage	Flash tested for 1 second	1000			VDC
Resistance	Viso= 500VDC	1	10		GΩ
Capacitance			25		pF

### TECHNICAL NOTES

#### ISOLATION VOLTAGE

'Hi Pot Test', 'Flash Tested', 'Withstand Voltage', 'Proof Voltage', 'Dielectric Withstand Voltage' & 'Isolation Test Voltage' are all terms that relate to the same thing, a test voltage, applied for a specified time, across a component designed to provide electrical isolation, to verify the integrity of that isolation.

Murata Power Solutions NTF series of DC/DC converters are all 100% production tested at their stated isolation voltage. This is 1kVDC for 1 second.

A question commonly asked is, "What is the continuous voltage that can be applied across the part in normal operation?"

For a part holding no specific agency approvals, such as the NTF series, both input and output should normally be maintained within SELV limits i.e. less than 42.4V peak, or 60VDC. The isolation test voltage represents a measure of immunity to transient voltages and the part should never be used as an element of a safety isolation system. The part could be expected to function correctly with several hundred volts offset applied continuously across the isolation barrier; but then the circuitry on both sides of the barrier must be regarded as operating at an unsafe voltage and further isolation/insulation systems must form a barrier between these circuits and any user-accessible circuitry according to safety standard requirements.

#### REPEATED HIGH-VOLTAGE ISOLATION TESTING

It is well known that repeated high-voltage isolation testing of a barrier component can actually degrade isolation capability, to a lesser or greater degree depending on materials, construction and environment. The NTF series has toroidal isolation transformers, with no additional insulation between primary and secondary windings of enameled wire. While parts can be expected to withstand several times the stated test voltage, the isolation capability does depend on the wire insulation. Any material, including this enamel (typically polyurethane) is susceptible to eventual chemical degradation when subject to very high applied voltages thus implying that the number of tests should be strictly limited. We therefore strongly advise against repeated high voltage isolation testing, but if it is absolutely required, that the voltage be reduced by 20% from specified test voltage.

This consideration equally applies to agency recognized parts rated for better than functional isolation where the wire enamel insulation is always supplemented by a further insulation system of physical spacing or barriers.

**TEMPERATURE DERATING**

**NTFS0505**

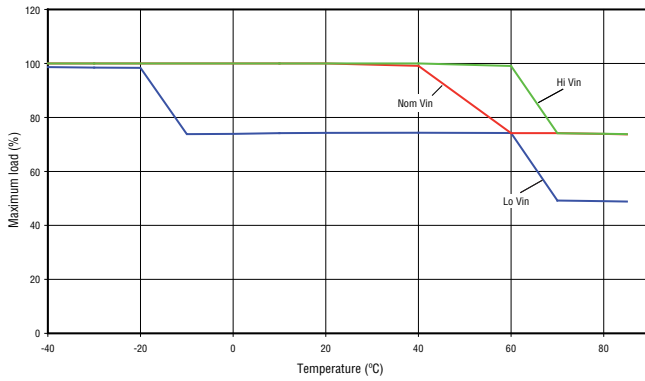

**NTFS0512**

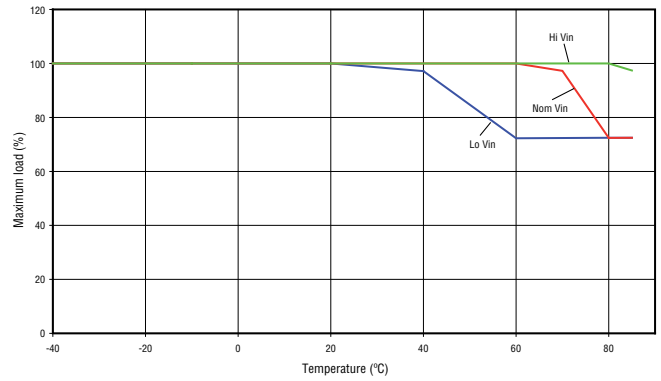

**NTFS0515**

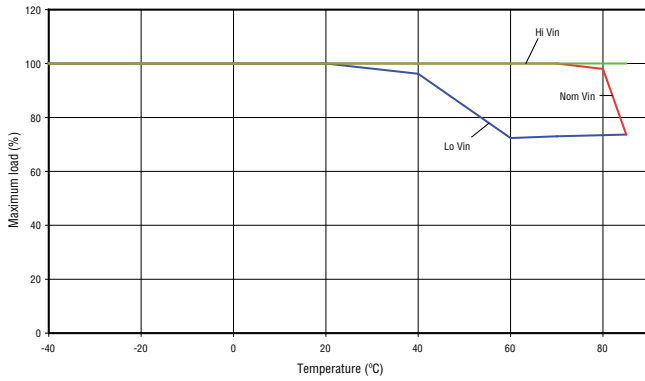

**NTFS1205**

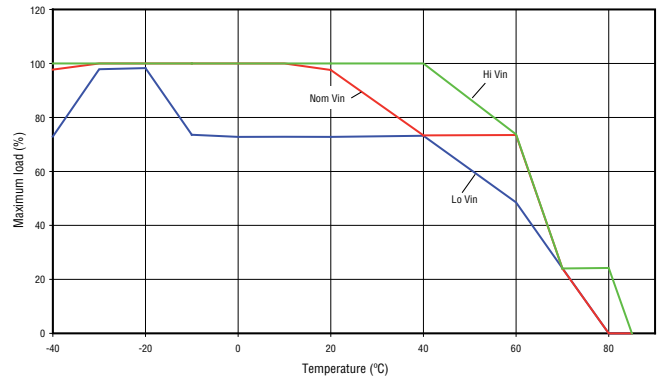

**NTFS1212**

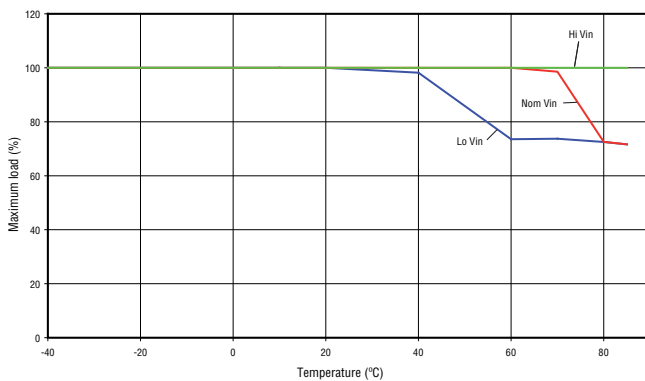

**NTFS1215**

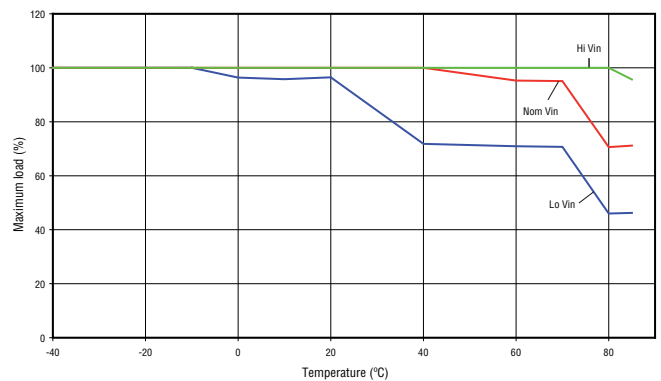

## TEMPERATURE DERATING

**NTFS2405**

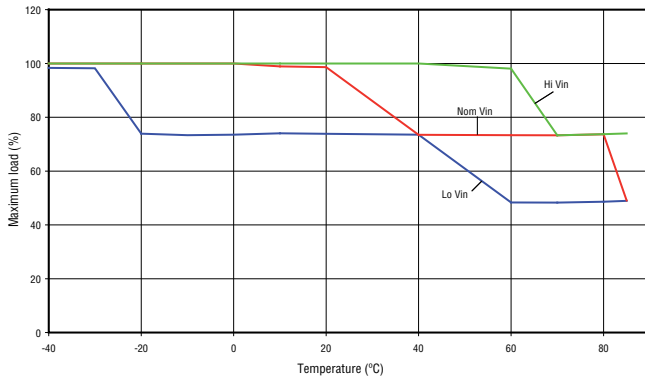

**NTFS2412**

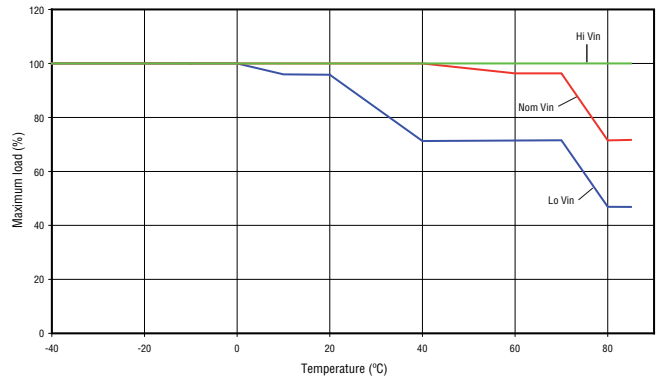

**NTFS2415**

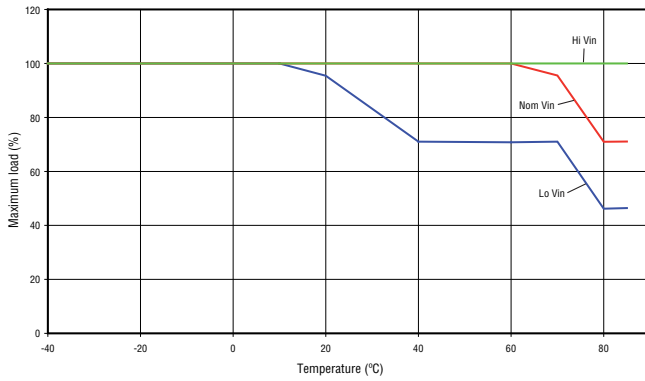

**MINIMUM LOAD**

**NTFS05XX**

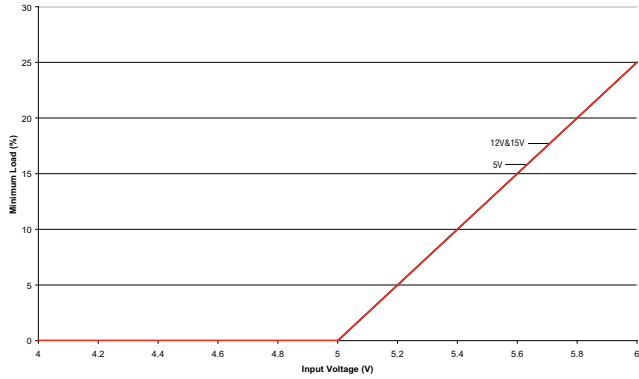

**NTFS12XX**

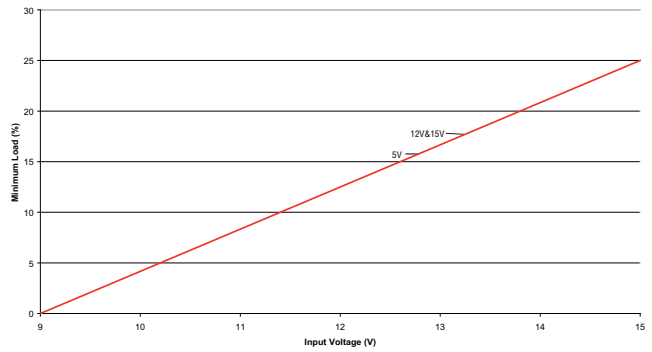

**NTFS24XX**

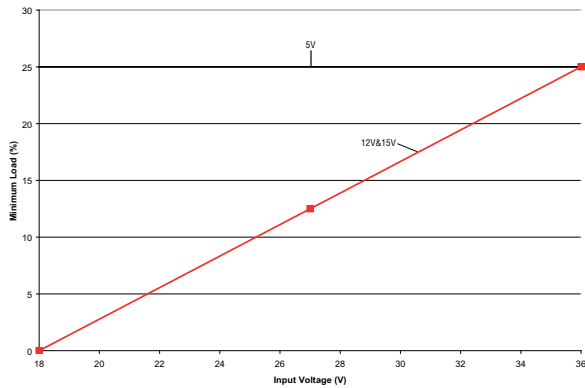

**RoHS COMPLIANCE INFORMATION**



This series is compatible with RoHS soldering systems with a peak reflow solder temperature of 245°C and time above liquidus of 217°C for 80 seconds. The pin termination finish on this product series is Gold, plating thickness 0.1 microns minimum. The series is backward compatible with Sn/Pb soldering systems.

For further information, please visit [www.murata-ps.com/rohs](http://www.murata-ps.com/rohs)

**APPLICATION NOTES**

Recommended input & output capacitors

Although these converters will work without external capacitors, they are necessary in order to guarantee the full parametric performance over the full line and load range. All parts have been tested and characterized using the following values and test circuit.

Value	
$C_{IN}$	$C_{OUT}$
10 $\mu$ F, 200V good low esr capacitor	22 $\mu$ F, 16V good low esr capacitor

Test circuit, 5V, 12V and 15V output

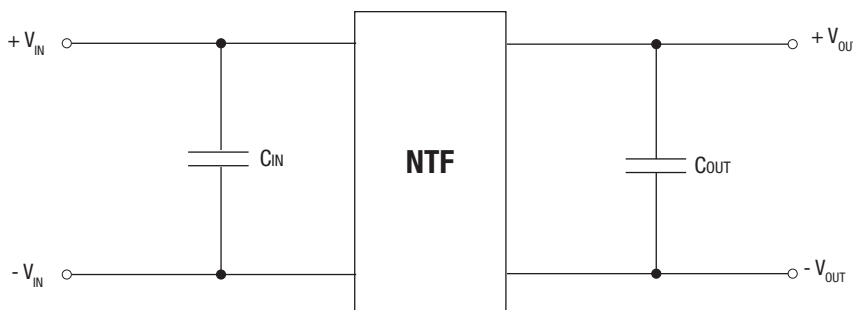

ON/OFF Pin

This provides an OFF function, which puts the converter into a low power mode. When the pin is un-connected, the converter is on. The circuit used must be able to sink a peak current of 50mA to guarantee turning the converter off. The circuit should be an open collector arrangement, an example circuit is shown below. Voltages should not be applied directly to the ON/OFF pin. The BC547 should be fitted close to the NTF ON/OFF pin to prevent the addition of excess wiring capacitance.

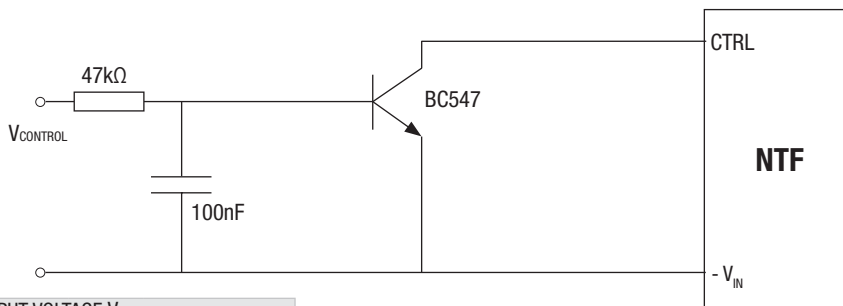

CONTROL PIN CIRCUIT INPUT VOLTAGE $V_{CONTROL}$			
	Min.	Max.	Units
Module ON	0	0.2	V
Module OFF	1.6	30	V

Output voltage adjustment

The trim resistor equations are:  $R_{DOWN} = \left[ \frac{(V_{DOWN} - L) \times G}{V_{NOM} - V_{DOWN}} \right]$  Where:  
 $R_{UP} = \left[ \frac{G \times L}{V_{UP} - L - K} \right]$

	G	L	K
NTFS0505MC	30100	1.24	3.76
NTFS1205MC, NTFS2405MC	100000	1.24	3.76
NTFSXX12MC	38300	2.5	9.5
NTSFX15MC	49900	2.5	12.5

TRIM UP

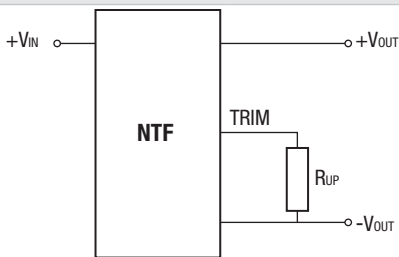

TRIM DOWN

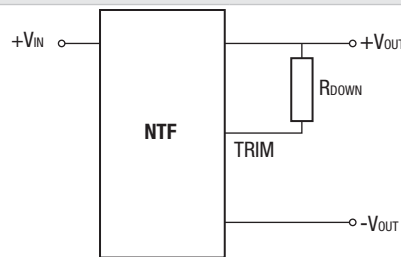

When the output voltage is trimmed up, output current must be derated so that the maximum output power is not exceeded.

**PACKAGE SPECIFICATIONS**

**MECHANICAL DIMENSIONS**

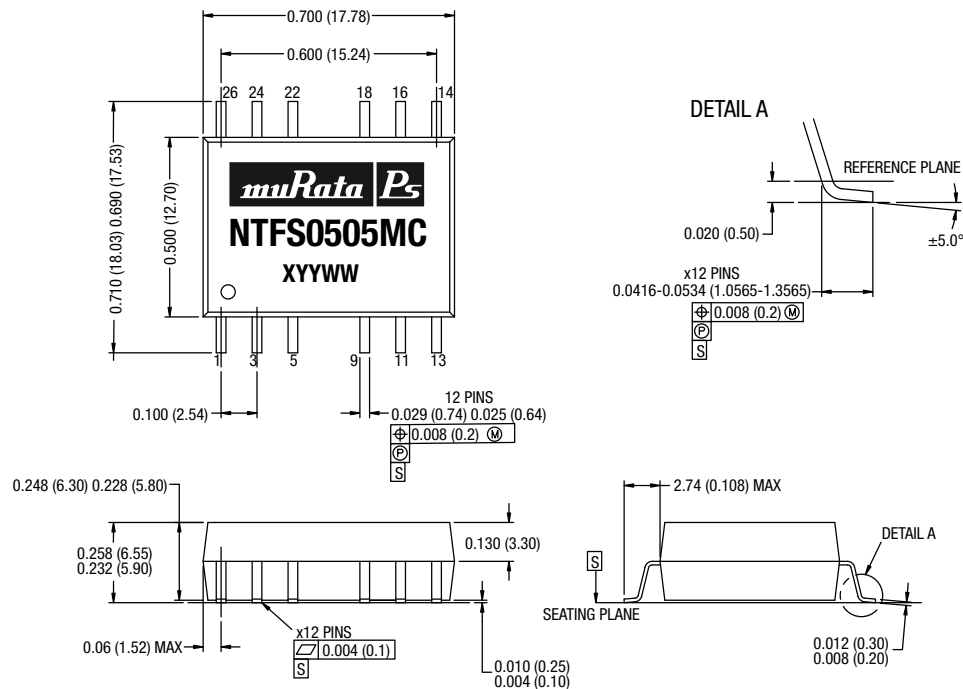

**PIN CONNECTIONS**

Pin	Function
1	-VIN
3	+VIN
5	NA
9	NA
11	-VOUT
13	+VOUT
14	NA
16	TRIM
18	NA
22	ON/OFF
24	NA
26	NA

NA - Not available for electrical connection.

All dimensions in inches  $\pm 0.01$  (mm  $\pm 0.25$ mm). All pins on a 0.1 (2.54) pitch.

Weight: 2.8g

**RECOMMENDED FOOTPRINT DETAILS**

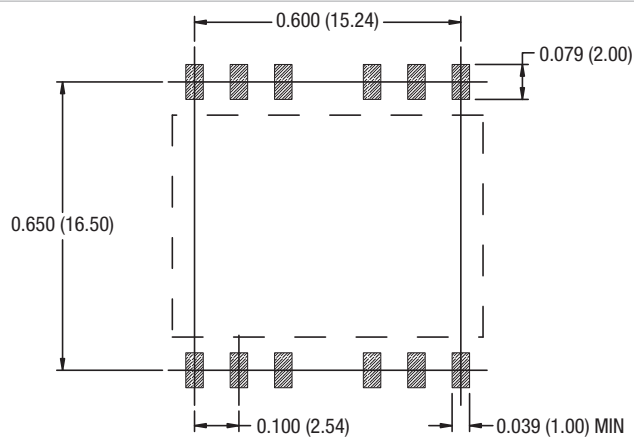

All dimensions in inches  $\pm 0.02$  (mm  $\pm 0.5$ )

**TUBE OUTLINE DIMENSIONS**

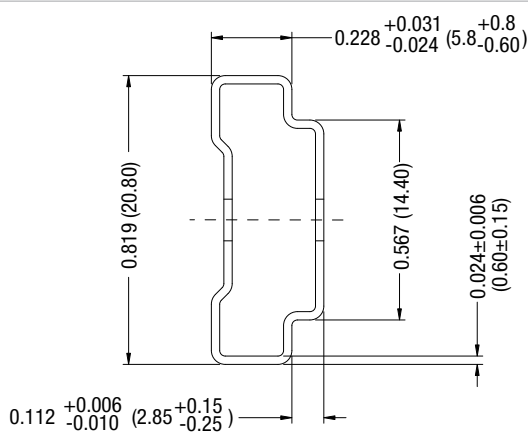

All dimensions in inches  $\pm 0.02$  (mm  $\pm 0.5$ ).  
Tube length : 18.70  $\pm 0.075$  (475  $\pm 2.0$ ).

Tube Quantity : 25

**TAPE & REEL SPECIFICATIONS**

**REEL OUTLINE DIMENSIONS**

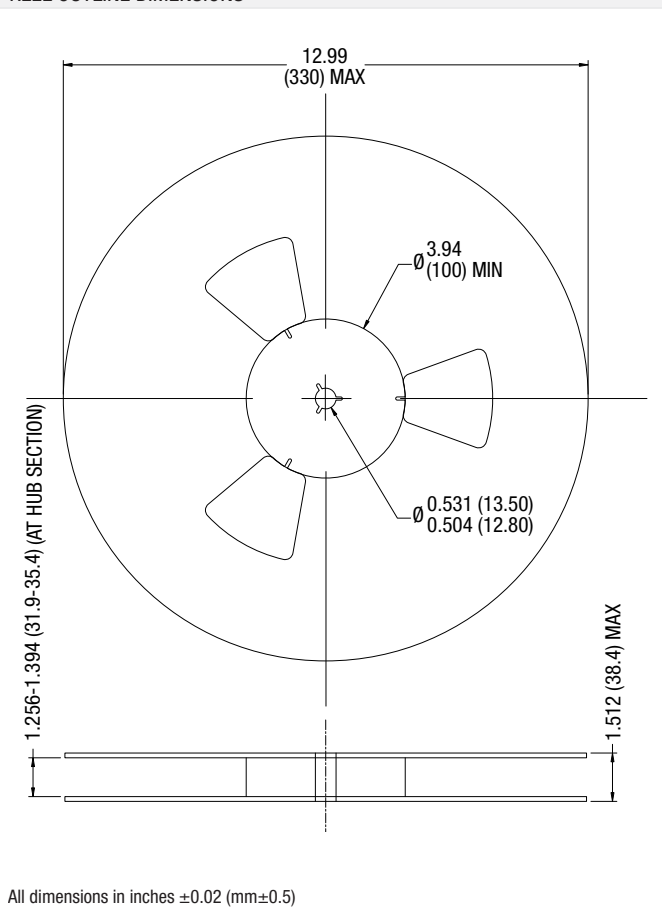

**TAPE OUTLINE DIMENSIONS**

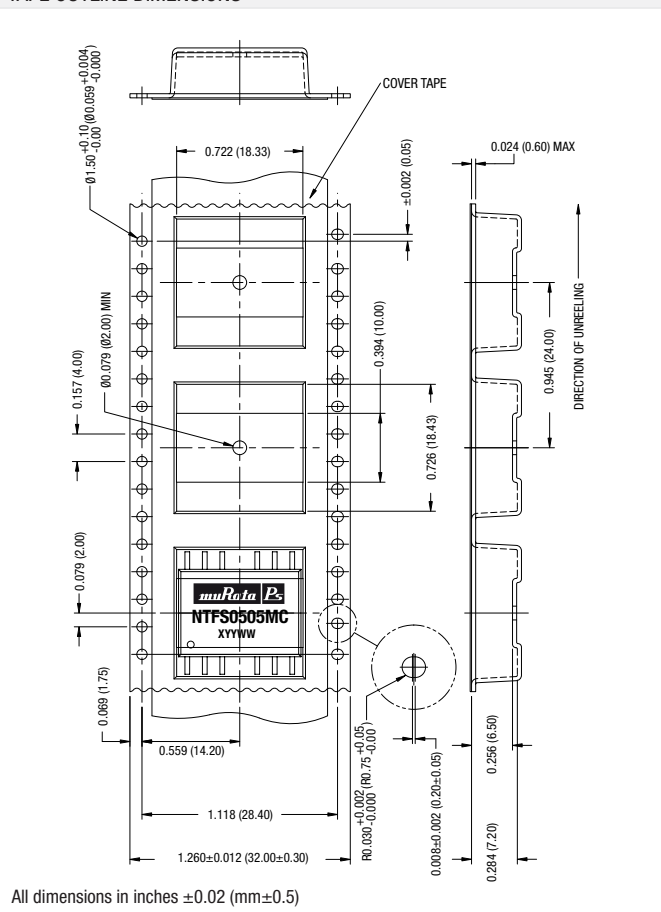

**REEL PACKAGING DETAILS**

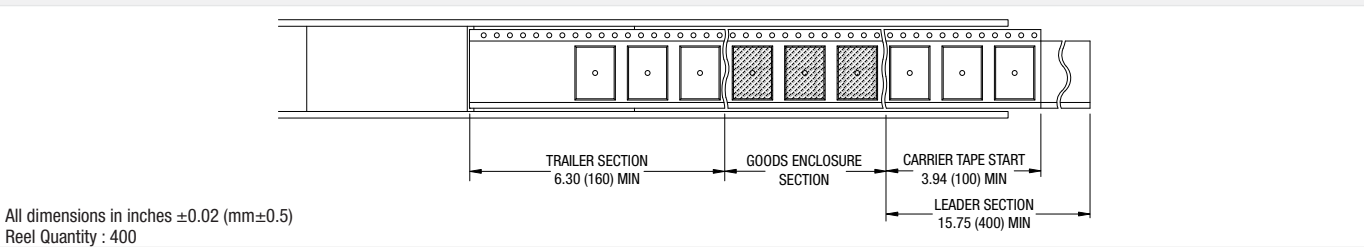

Murata Power Solutions, Inc.  
11 Cabot Boulevard, Mansfield, MA 02048-1151 U.S.A.  
Tel: (508) 339-3000 (800) 233-2765 Fax: (508) 339-6356  
[www.murata-ps.com](http://www.murata-ps.com) email: [sales@murata-ps.com](mailto:sales@murata-ps.com) ISO 9001 & ISO 14001 REGISTERED

Murata Power Solutions, Inc. makes no representation that the use of its products in the circuits described herein, or the use of other technical information contained herein, will not infringe upon existing or future patent rights. The descriptions contained herein do not imply the granting of licenses to make, use, or sell equipment constructed in accordance therewith. Specifications are subject to change without notice.  
© 2009 Murata Power Solutions, Inc.

- USA:** Mansfield (MA), Tel: (508) 339 3000, email: [sales@murata-ps.com](mailto:sales@murata-ps.com)
- Canada:** Toronto, Tel: (866) 740 1232, email: [toronto@murata-ps.com](mailto:toronto@murata-ps.com)
- UK:** Milton Keynes, Tel: +44 (0)1908 615232, email: [mk@murata-ps.com](mailto:mk@murata-ps.com)
- France:** Montigny Le Bretonneux, Tel: +33 (0)1 34 60 01 01, email: [france@murata-ps.com](mailto:france@murata-ps.com)
- Germany:** München, Tel: +49 (0)89-544334-0, email: [ped.munich@murata-ps.com](mailto:ped.munich@murata-ps.com)
- Japan:** Tokyo, Tel: 3-3779-1031, email: [sales\\_tokyo@murata-ps.com](mailto:sales_tokyo@murata-ps.com)  
Osaka, Tel: 6-6354-2025, email: [sales\\_osaka@murata-ps.com](mailto:sales_osaka@murata-ps.com)
- China:** Shanghai, Tel: +86 215 027 3678, email: [shanghai@murata-ps.com](mailto:shanghai@murata-ps.com)  
Guangzhou, Tel: +86 208 221 8066, email: [guangzhou@murata-ps.com](mailto:guangzhou@murata-ps.com)
- Singapore:** Parkway Centre, Tel: +65 6348 9096, email: [singapore@murata-ps.com](mailto:singapore@murata-ps.com)