

HLMP-4700, HLMP-4719, HLMP-4740
HLMP-1700, HLMP-1719, HLMP-1790
 T-1^{3/4} (5 mm), T-1 (3 mm), Low Current LED Lamps



Data Sheet

Description

These tinted diffused LED lamps are designed and optimized specifically for low DC current operation. Luminous intensity and forward voltage are tested at 2 mA to assure consistent brightness at TTL output current levels.

Applications

- Low power DC circuits
- Telecommunications indicators
- Portable equipment
- Keyboard indicators

Features

- Low power
- High efficiency
- CMOS-MOS compatible
- TTL compatible
- Wide viewing angle
- Choice of package styles
- Choice of colors

Package Dimensions



A - HLMP-4700, -4719, -4740

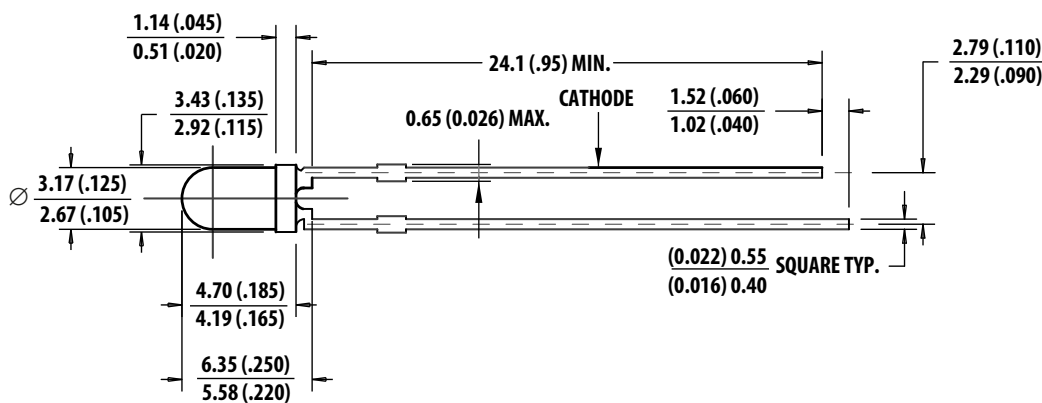

B - HLMP-1700, -1719, -1790

Notes:

1. All dimensions are in mm (inches).
2. An epoxy meniscus may extend about 1 mm (0.040") down the leads.
3. For PCB hole recommendations, see the Precautions section.

Selection Guide

Package Description	Color	Device HLMP-	Luminous Intensity I _v (mcd) at 2 mA			2θ ^{1/2}	Package Outline
			Min.	Typ.	Max.		
T-1 3/4 Tinted Diffused	Red	4700	1.5	2.3	–	50	A
		4700-C00xx	1.5	2.3	–		
		4700-CD0FH	1.5	2.3	4.2		
	Yellow	4719	0.9	2.1	–		
		4719-A00xx	0.9	2.1	–		
	Green	4740	1.0	2.3	–		
		4740-A00xx	1.0	2.3	–		
		4740-AB000	1.0	2.3	3.2		
	T-1 Tinted Diffused	Red	1700	0.8	2.1		
1700-B00xx			0.8	2.1	–		
Yellow		1719	0.9	2.1	–		
		1719-A00xx	0.9	2.1	–		
		1719-ABB00	0.9	2.1	2.8		
Green		1790	1.0	2.3	–		
		1790-A00xx	1.0	2.3	–		
		1790-AB0FH	1.0	2.4	3.2		

Note:

1. θ^{1/2} is the typical off-axis angle at which the luminous intensity is half the axial luminous intensity.

Part Numbering System

HLMP - X 7 XX - X X X XX



Electrical/Optical Characteristics at $T_A = 25^\circ\text{C}$

Symbol	Description	T-1 ^{3/4}	T-1	Min.	Typ.	Max.	Units	Test Conditions
V _F	Forward Voltage	4700	1700		1.7	2.0	V	2 mA
		4719	1719		1.8	2.5		
		4740	1790		1.9	2.2		
V _R	Reverse Breakdown Voltage	4700	1700	5.0			V	I _R = 50 μA
		4719	1719	5.0				
		4740	1790	5.0				
λ _d	Dominant Wavelength	4700	1700		626		nm	Note 1
		4719	1719		585			
		4740	1790		569			
Δλ _{1/2}	Spectral Line Halfwidth	4700	1700		40		nm	
		4719	1719		36			
		4740	1790		28			
τ _S	Speed of Response	4700	1700		90		ns	
		4719	1719		90			
		4740	1790		500			
C	Capacitance	4700	1700		11		pF	V _F = 0, f = 1 MHz
		4719	1719		15			
		4740	1790		18			
Rθ _{J-PIN}	Thermal Resistance	4700	1700		260 ^[3]		°C/W	Junction to Cathode Lead
		4719	1719		290 ^[4]			
		4740	1790					
λ _{PEAK}	Peak Wavelength	4700	1700		635		nm	Measurement at Peak
		4740	1790		565			
η _V	Luminous Efficacy	4700	1700		145		lumens/watt	Note 2
		4719	1719		500			
		4740	1790		595			

Notes:

1. The dominant wavelength, λ_d, is derived from the CIE chromaticity diagram and represents the single wavelength which defines the color of the device.
2. The radiant intensity, I_e, in watts per steradian, may be found from the equation I_e = I_v/η_V, where I_v is the luminous intensity in candelas and η_V is luminous efficacy in lumens/watt.
3. T-1^{3/4}.
4. T-1.

Absolute Maximum Ratings

Parameter		Maximum Rating	Units
Power Dissipation (Derate linearly from 92°C at 1.0 mA/°C)	Red	14	mW
	Yellow	17.5	
	Green	15.4	
DC and Peak Forward Current		7	mA
Transient Forward Current (10 μs Pulse) ^[1]		500	mA
Reverse Voltage (I _R = 50 μA)		5.0	V
Operating Temperature Range	Red/Yellow	-40 to 100	°C
	Green	-20 to 100	°C
Storage Temperature Range		-40 to +100	°C

Notes:

- The transient peak current is the maximum non-recurring peak current the devices can withstand without damaging the LED die and wire bonds. It is not recommended that the device be operated at peak currents beyond the Absolute Maximum Peak Forward Current.



Figure 1. Relative intensity vs. wavelength.



Figure 2. Forward current vs. forward voltage.



Figure 3. Relative luminous intensity vs. forward current.



Figure 4. Relative luminous intensity vs. angular displacement for T-1^{3/4} lamp.

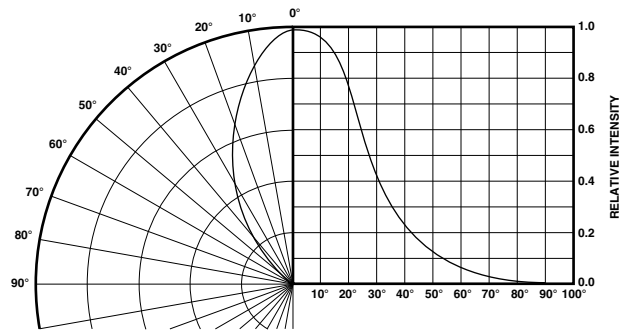

Figure 5. Relative illuminous intensity vs. angular displacement for T-1 lamp.

Intensity Bin Limits

Color	Bin	Intensity Range (mcd)	
		Min.	Max.
Red	B	0.9	1.5
	C	1.5	2.4
	D	2.4	3.8
	E	3.8	6.1
	F	6.1	9.7
	G	9.7	15.5
	H	15.5	24.8
	I	24.8	39.6
	J	39.6	63.4
	K	63.4	101.5
	L	101.5	162.4
	M	162.4	234.6
	N	234.6	340.0
	O	340.0	540.0
	P	540.0	850.0
	Q	850.0	1200.0
	R	1200.0	1700.0
	S	1700.0	2400.0
	T	2400.0	3400.0
	U	3400.0	4900.0
V	4900.0	7100.0	
W	7100.0	10200.0	
X	10200.0	14800.0	
Y	14800.0	21400.0	
Z	21400.0	30900.0	

Maximum tolerance for each bin limit is $\pm 18\%$.

Intensity Bin Limits

Color	Bin	Intensity Range (mcd)	
		Min.	Max.
Yellow	A	1.0	1.6
	B	1.6	2.5
	C	2.5	4.0
	D	4.0	6.5
	E	6.5	10.3
	F	10.3	16.6
	G	16.6	26.5
	H	26.5	42.3
	I	42.3	67.7
	J	67.7	108.2
	K	108.2	173.2
	L	173.2	250.0
	M	250.0	360.0
	N	360.0	510.0
	O	510.0	800.0
	P	800.0	1250.0
	Q	1250.0	1800.0
	R	1800.0	2900.0
	S	2900.0	4700.0
	T	4700.0	7200.0
U	7200.0	11700.0	
V	11700.0	18000.0	
W	18000.0	27000.0	

Maximum tolerance for each bin limit is $\pm 18\%$.

Intensity Bin Limits

Color	Bin	Intensity Range (mcd)	
		Min.	Max.
Green	A	1.1	1.8
	B	1.8	2.9
	C	2.9	4.7
	D	4.7	7.6
	E	7.6	12.0
	F	12.0	19.1
	G	19.1	30.7
	H	30.7	49.1
	I	49.1	78.5
	J	78.5	125.7
	K	125.7	201.1
	L	201.1	289.0
	M	289.0	417.0
	N	417.0	680.0
	O	680.0	1100.0
	P	1100.0	1800.0
	Q	1800.0	2700.0
R	2700.0	4300.0	
S	4300.0	6800.0	
T	6800.0	10800.0	
U	10800.0	16000.0	
V	16000.0	25000.0	
W	25000.0	40000.0	

Maximum tolerance for each bin limit is $\pm 18\%$.

Color Categories

Color	Category #	Lambda (nm)	
		Min.	Max.
Green	6	561.5	564.5
	5	564.5	567.5
	4	567.5	570.5
	3	570.5	573.5
	2	573.5	576.5
	1	582.0	584.5
Yellow	3	584.5	587.0
	2	587.0	589.5
	4	589.5	592.0
	5	592.0	593.0

Tolerance for each bin limit is ± 0.5 nm.

Mechanical Option Matrix

Mechanical Option Code	Definition
00	Bulk Packaging, minimum increment 500 pc/bag
01	Tape & Reel, crimped leads, min. increment 1300 pcs/bag for T-1 3/4, 1800 pcs/bag for T-1
02	Tape & Reel, straight leads, min. increment 1300 pcs/bag for T-1 3/4, 1800 pcs/bag for T-1
A1	T-1, Right Angle Housing, uneven leads, minimum increment 500 pcs/bag
A2	T-1, Right Angle Housing, even leads, minimum increment 500 pcs/bag
B1	T-1 3/4, Right Angle Housing, uneven leads, minimum increment 500 pcs/bag
B2	T-1 3/4, Right Angle Housing, even leads, minimum increment 500 pcs/bag
BH	T-1, Tape & Reel, straight leads, minimum increment 2000 pcs/bag
FH	Devices that require inventory control and 2 lv bin select
R1	Tape & Reel, crimped leads, reeled counter clockwise, cathode lead leaving the reel first

Notes: All categories are established for classification of products. Products may not be available in all categories. Please contact your local Avago representative for further clarification/information.

Precautions:

Lead Forming:

- The leads of an LED lamp may be preformed or cut to length prior to insertion and soldering on PC board.
- For better control, it is recommended to use proper tool to precisely form and cut the leads to applicable length rather than doing it manually.
- If manual lead cutting is necessary, cut the leads after the soldering process. The solder connection forms a mechanical ground which prevents mechanical stress due to lead cutting from traveling into LED package. This is highly recommended for hand solder operation, as the excess lead length also acts as small heat sink.

Soldering and Handling:

- Care must be taken during PCB assembly and soldering process to prevent damage to the LED component.
- LED component may be effectively hand soldered to PCB. However, it is only recommended under unavoidable circumstances such as rework. The closest manual soldering distance of the soldering heat source (soldering iron’s tip) to the body is 1.59mm. Soldering the LED using soldering iron tip closer than 1.59mm might damage the LED.

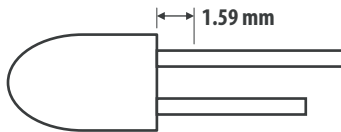

- ESD precaution must be properly applied on the soldering station and personnel to prevent ESD damage to the LED component that is ESD sensitive. Do refer to Avago application note AN 1142 for details. The soldering iron used should have grounded tip to ensure electrostatic charge is properly grounded.
- Recommended soldering condition:

	Wave Soldering^{[1],[2]}	Manual Solder Dipping
Pre-heat Temperature	105°C Max.	–
Pre-heat Time	60 sec Max.	–
Peak Temperature	250°C Max.	260°C Max.
Dwell Time	3 sec Max.	5 sec Max.

Note:

- 1) Above conditions refers to measurement with thermocouple mounted at the bottom of PCB.
- 2) It is recommended to use only bottom preheaters in order to reduce thermal stress experienced by LED.

- Wave soldering parameters must be set and maintained according to the recommended temperature and dwell time. Customer is advised to perform daily check on the soldering profile to ensure that it is always conforming to recommended soldering conditions.

Note:

1. PCB with different size and design (component density) will have different heat mass (heat capacity). This might cause a change in temperature experienced by the board if same wave soldering setting is used. So, it is recommended to re-calibrate the soldering profile again before loading a new type of PCB.
2. Customer is advised to take extra precaution during wave soldering to ensure that the maximum wave temperature does not exceed 250°C and the solder contact time does not exceeding 3sec. Over-stressing the LED during soldering process might cause premature failure to the LED due to delamination.

- Any alignment fixture that is being applied during wave soldering should be loosely fitted and should not apply weight or force on LED. Non metal material is recommended as it will absorb less heat during wave soldering process.

- At elevated temperature, LED is more susceptible to mechanical stress. Therefore, PCB must allowed to cool down to room temperature prior to handling, which includes removal of alignment fixture or pallet.

- If PCB board contains both through hole (TH) LED and other surface mount components, it is recommended that surface mount components be soldered on the top side of the PCB. If surface mount need to be on the bottom side, these components should be soldered using reflow soldering prior to insertion the TH LED.

- Recommended PC board plated through holes (PTH) size for LED component leads.

	LED Component Lead Size	Diagonal	Plated Through-Hole Diameter
Lead size (typ.)	0.45 × 0.45 mm (0.018 × 0.018 in.)	0.636 mm (0.025 in)	0.98 to 1.08 mm (0.039 to 0.043 in)
Dambar shear-off area (max.)	0.65 mm (0.026 in)	0.919 mm (0.036 in)	
Lead size (typ.)	0.50 × 0.50 mm (0.020 × 0.020 in.)	0.707 mm (0.028 in)	1.05 to 1.15 mm (0.041 to 0.045 in)
Dambar shear-off area (max.)	0.70 mm (0.028 in)	0.99 mm (0.039 in)	

Note: Refer to application note AN1027 for more information on soldering LED components.

- Over-sizing the PTH can lead to twisted LED after clinching. On the other hand under sizing the PTH can cause difficulty inserting the TH LED.

Refer to application note AN5334 for more information about soldering and handling of TH LED lamps.

Example of Wave Soldering Temperature Profile for TH LED

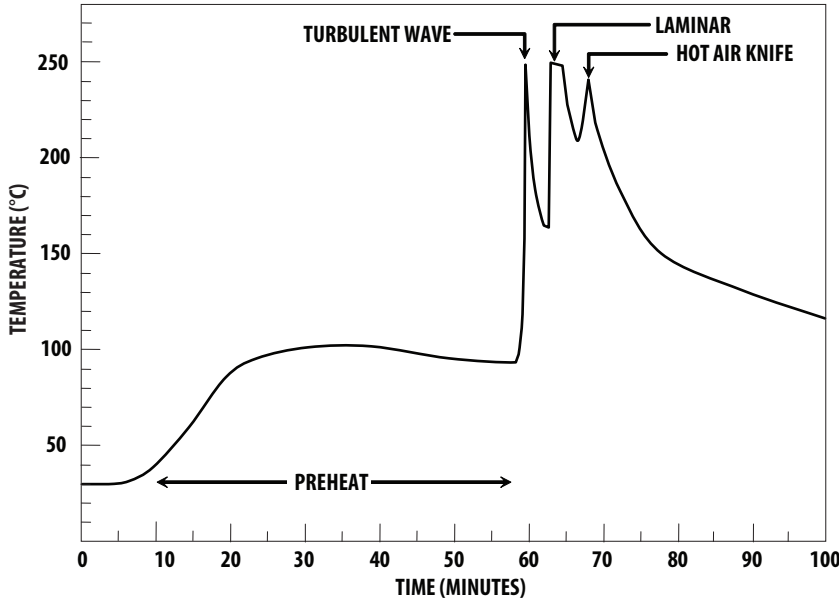

Recommended solder:
 Sn63 (Leaded solder alloy)
 SAC305 (Lead free solder alloy)

Flux: Rosin flux

Solder bath temperature:
 245°C ± 5°C (maximum peak temperature = 250°C)

Dwell time: 1.5 sec – 3.0 sec (maximum = 3sec)

Note: Allow for board to be sufficiently cooled to room temperature before exerting mechanical force.

Recommended solder:
 Sn63 (Leaded solder alloy)
 SAC305 (Lead free solder alloy)

Flux: Rosin flux

Solder bath temperature:
 245°C ± 5°C (maximum peak temperature = 250°C)

Dwell time: 1.5 sec – 3.0 sec (maximum = 3sec)











Note: Allow for board to be sufficiently cooled to room temperature before exerting mechanical force.

Packaging Label:

(i) Avago Mother Label: (Available on packaging box of ammo pack and shipping box)

AVAGO TECHNOLOGIES	
(1P) Item: Part Number [Barcode]	STANDARD LABEL LS0002
(1T) Lot: Lot Number [Barcode]	RoHS Compliant
LPN: [Barcode]	e3 max temp 250C
(9D)MFG Date: Manufacturing Date [Barcode]	(Q) QTY: Quantity [Barcode]
(P) Customer Item: [Barcode]	CAT: Intensity Bin [Barcode]
(V) Vendor ID: [Barcode]	BIN: Color Bin [Barcode]
(9D) Date Code: Date Code [Barcode]	
DeptID: [Barcode]	Made In: Country of Origin [Barcode]

(ii) Avago Baby Label (Only available on bulk packaging)

 Lamps Baby Label		RoHS Compliant e3 max temp 250C
(1P) PART #: Part Number 		
(1T) LOT #: Lot Number 		
(9D)MFG DATE: Manufacturing Date 	QUANTITY: Packing Quantity 	
C/O: Country of Origin		
Customer P/N: 	CAT: Intensity Bin 	
Supplier Code: 	BIN: Color Bin 	
	DATECODE: Date Code 	

For product information and a complete list of distributors, please go to our web site: www.avagotech.com

Avago, Avago Technologies, and the A logo are trademarks of Avago Technologies in the United States and other countries. Data subject to change. Copyright © 2005-2013 Avago Technologies. All rights reserved. Obsoletes 5989-4256EN AV02-1557EN - August 22, 2013

