

CMOS 8-bit Microcontroller

TMP87P809N/M

The TMP87P809 is a high-speed, high-performance 8-bit single chip microcomputer, which has 64-Kbits One-Time PROM. The TMP87P809 is pin compatible with the TMP87C409B/809B. The operations possible with the TMP87C409B/809B can be performed by writing programs to PROM. The TMP87P809 can write and verify in the same way as the TC57256AD using an adapter socket and a general-purpose PROM programmer.

Product No.	ROM	RAM	Package	Adapter socket
TMP87P809N	8 Kbytes	256 bytes	P-SDIP28-400-1.78	BM11122
TMP87P809M			P-SOP28-450-1.27	BM11116

Pin Assignments (Top View)

SOP28 / SDIP28

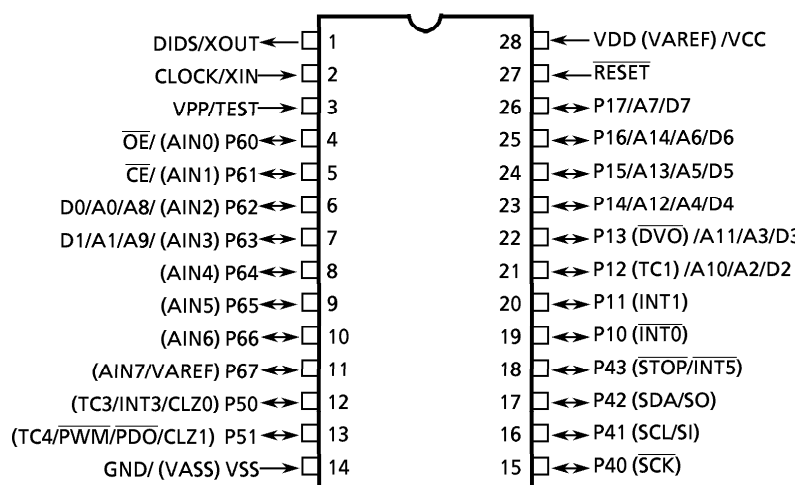

P-SDIP28-400-1.78

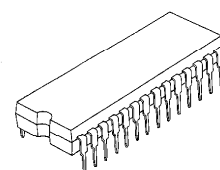

TMP87P809N

P-SOP28-450-1.27

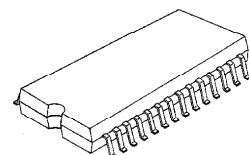

TMP87P809M

000707EBA1

- For a discussion of how the reliability of microcontrollers can be predicted, please refer to Section 1.3 of the chapter entitled Quality and Reliability Assurance / Handling Precautions.
- TOSHIBA is continually working to improve the quality and reliability of its products. Nevertheless, semiconductor devices in general can malfunction or fail due to their inherent electrical sensitivity and vulnerability to physical stress. It is the responsibility of the buyer, when utilizing TOSHIBA products, to comply with the standards of safety in making a safe design for the entire system, and to avoid situations in which a malfunction or failure of such TOSHIBA products could cause loss of human life, bodily injury or damage to property. In developing your designs, please ensure that TOSHIBA products are used within specified operating ranges as set forth in the most recent TOSHIBA products specifications. Also, please keep in mind the precautions and conditions set forth in the "Handling Guide for Semiconductor Devices," or "TOSHIBA Semiconductor Reliability Handbook" etc..
- The TOSHIBA products listed in this document are intended for usage in general electronics applications (computer, personal equipment, office equipment, measuring equipment, industrial robotics, domestic appliances, etc.). These TOSHIBA products are neither intended nor warranted for usage in equipment that requires extraordinarily high quality and/or reliability or a malfunction or failure of which may cause loss of human life or bodily injury ("Unintended Usage"). Unintended Usage include atomic energy control instruments, airplane or spaceship instruments, transportation instruments, traffic signal instruments, combustion control instruments, medical instruments, all types of safety devices, etc.. Unintended Usage of TOSHIBA products listed in this document shall be made at the customer's own risk.
- The products described in this document are subject to the foreign exchange and foreign trade laws.
- The information contained herein is presented only as a guide for the applications of our products. No responsibility is assumed by TOSHIBA CORPORATION for any infringements of intellectual property or other rights of the third parties which may result from its use. No license is granted by implication or otherwise under any intellectual property or other rights of TOSHIBA CORPORATION or others.
- The information contained herein is subject to change without notice.

Pin Function

The TMP87P809 has two modes: MCU and PROM.

(1) MCU mode

In this mode, the TMP87P809 is pin compatible with the TMP87C409B/809B (fix the TEST pin at "L" level).

(2) PROM mode

Pin Name (PROM mode)	Input / Output	Functions	Pin name (MCU mode)
A14 to A8	Input	Program memory address input	P17 to P12, P63, P62
A7 to A0			P17 to P12, P63, P62
D7 to D0	I/O	Program memory data input/output	P17 to P12, P63, P62
\overline{CE}	Input	Chip enable signal input	P61
\overline{OE}		Output enable signal input	P60
VPP	Power supply	+ 12.5 V / 5 V (Program supply voltage)	TEST
VCC		+ 5 V	VDD
GND		0 V	VSS
P11 to P10	I/O	PROM mode setting pins. Be fixed at "L" level.	
P43 to P40			
P51 to P50			
P67 to P64			
\overline{RESET}	Input		
XIN	Input	Inputs a clock externally. (CLOCK)	XIN
XOUT	Input	PROM mode control signal (DIDS) input	XOUT

Operational Description

The configuration and function of the TMP87P809 are the same as those of the TMP87C409B/809B, except in that a one-time PROM is used instead of an on-chip mask ROM.

1. Operating Mode

The TMP87P809 has two modes: MCU and PROM.

1.1 MCU Mode

The MCU mode is activated by fixing the TEST/VPP pin at "L" level.

In the MCU mode, operation is the same as with the TMP87C409B/809B (TEST/VPP pin cannot be used open because it has no built in pull-down resistance.)

1.1.1 Program memory

The TMP87P809 has a 8 Kbyte (addresses E000 to FFFF_H in the MCU mode, addresses 6000 to 7FFF_H in the PROM mode) one-time PROM.

To use the TMP87P809 as the system evaluation for the TMP87C409B/809B, the program should be written to the program memory area as shown in Figure 1-1.

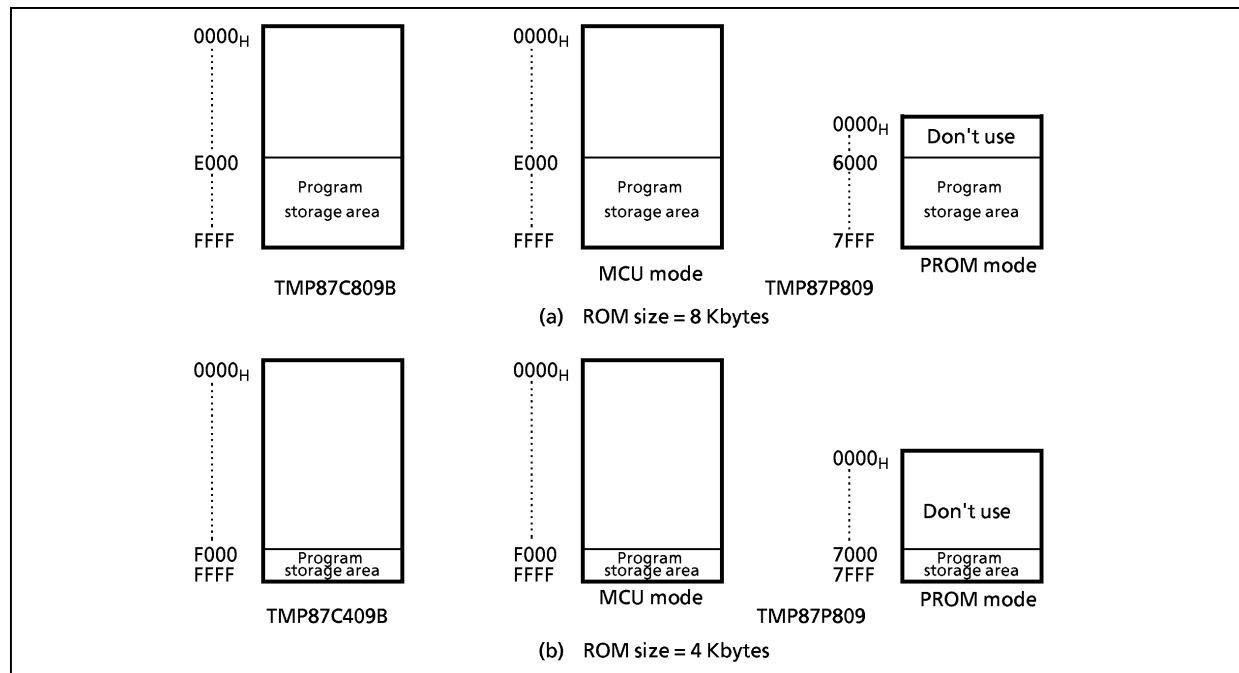

Figure 1-1. Program memory area

Note: Either write the data FFH to the unused area or set the general-purpose PROM programmer to access only the program storage area

1.1.2 Data memory

The TMP87P809 has an 256 bytes data memory (static RAM).

1.1.3 Input / Output circuits

(1) Control pins

The control pins of the TMP87P809 are the same as those of the TMP87C409B/809B except that the TEST pin has no built-in pull-down resistance.

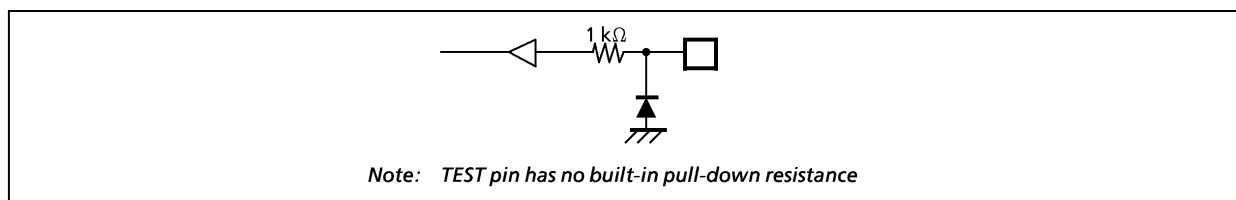

Figure 1-2. TEST Pin

(2) I/O port

The I/O circuits of TMP87P809 ports are the same as the TMP87C409B/809B.

1.2 PROM Mode

The PROM mode is used to write and verify programs with a general-purpose PROM programmer.

Note: Please set the high-speed programming mode according to each manual of PROM programmer.

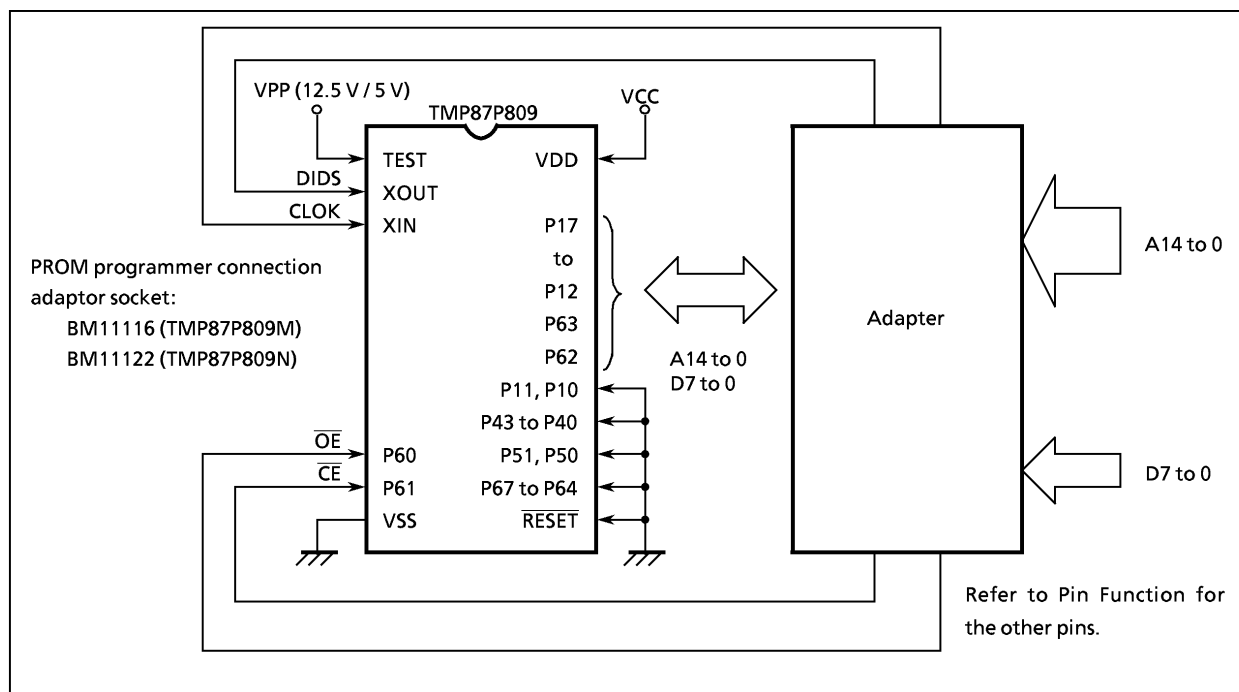

Figure 1-3. Setting for PROM mode

1.2.1 Programming flowchart (High-speed Programming Mode-I)

The high-speed programming mode is achieved by applying the program voltage (+ 12.5 V) to the V_{pp} pin when V_{cc} = 6 V. After the address and input data are stable, the data is programmed by applying a single 1ms program pulse to the \overline{CE} input. The programmed data is verified. If incorrect, another 1ms program pulse is applied and then the programmed data is verified. This process should be repeated (up to 25 times) until the program operates correctly. Programming for one address is ended by applying additional program pulse with width 3 times that needed for initial programming (number of programmed times × 1 ms). After that, change the address and input data, and program as before. When programming has been completed, the data in all addresses should be verified with V_{cc} = V_{pp} = 5 V.

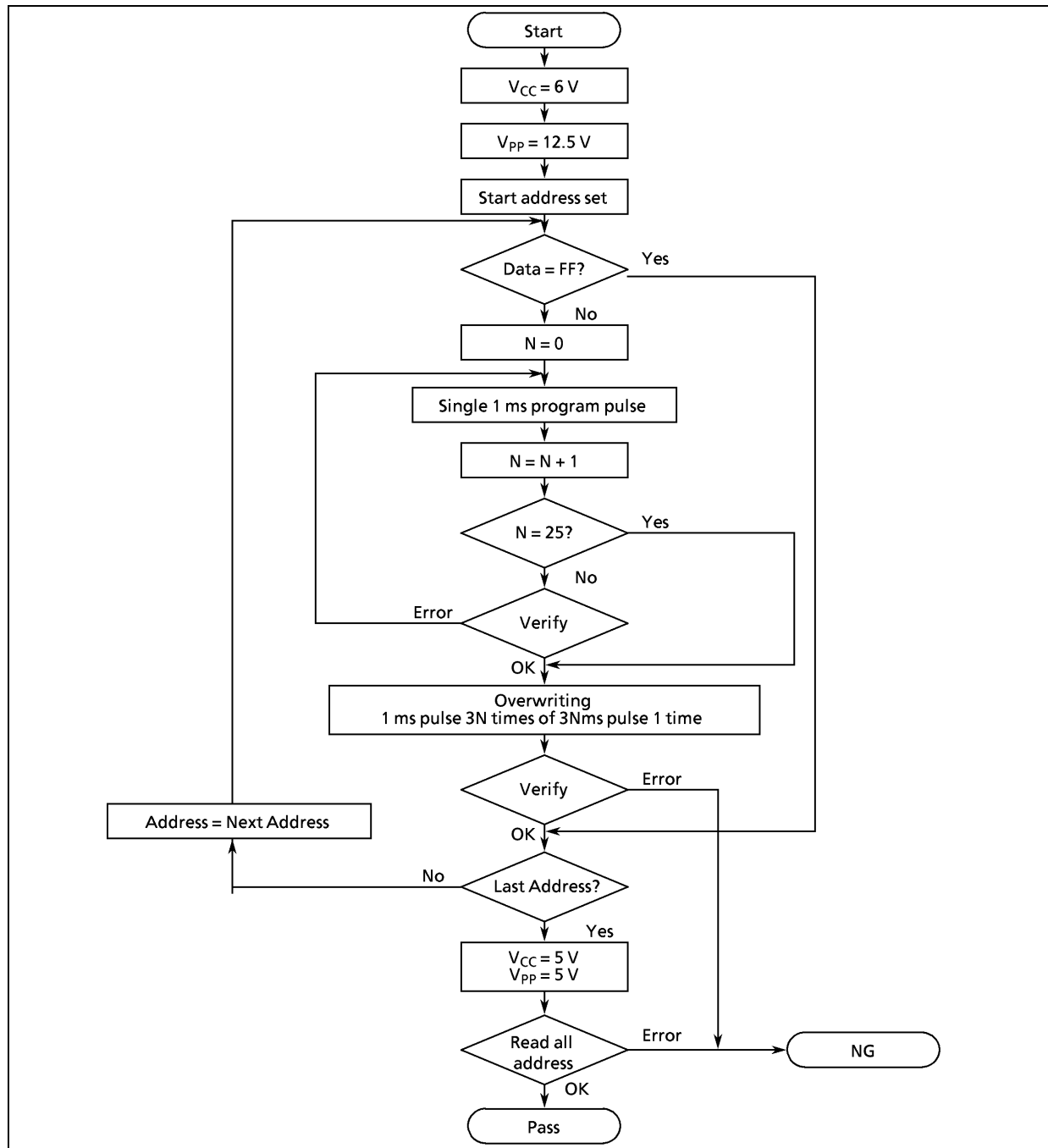

Figure 1-4. Flowchart of high-speed programming mode - I

1.2.2 Programming flowchart (High-speed Programming Mode-II)

The high-speed programming mode is achieved by applying the program voltage (+ 12.75 V) to the Vpp pin when Vcc = 6.25 V. After the address and input data are stable, the data is programmed by applying a single 0.1ms program pulse to the \overline{CE} input. The programmed data is verified. If incorrect, another 0.1ms program pulse is applied and then the programmed data is verified. This process should be repeated (up to 25 times) until the program operates correctly. After that, change the address and input data, and program as before. When programming has been completed, the data in all addresses should be verified with Vcc = Vpp = 5 V.

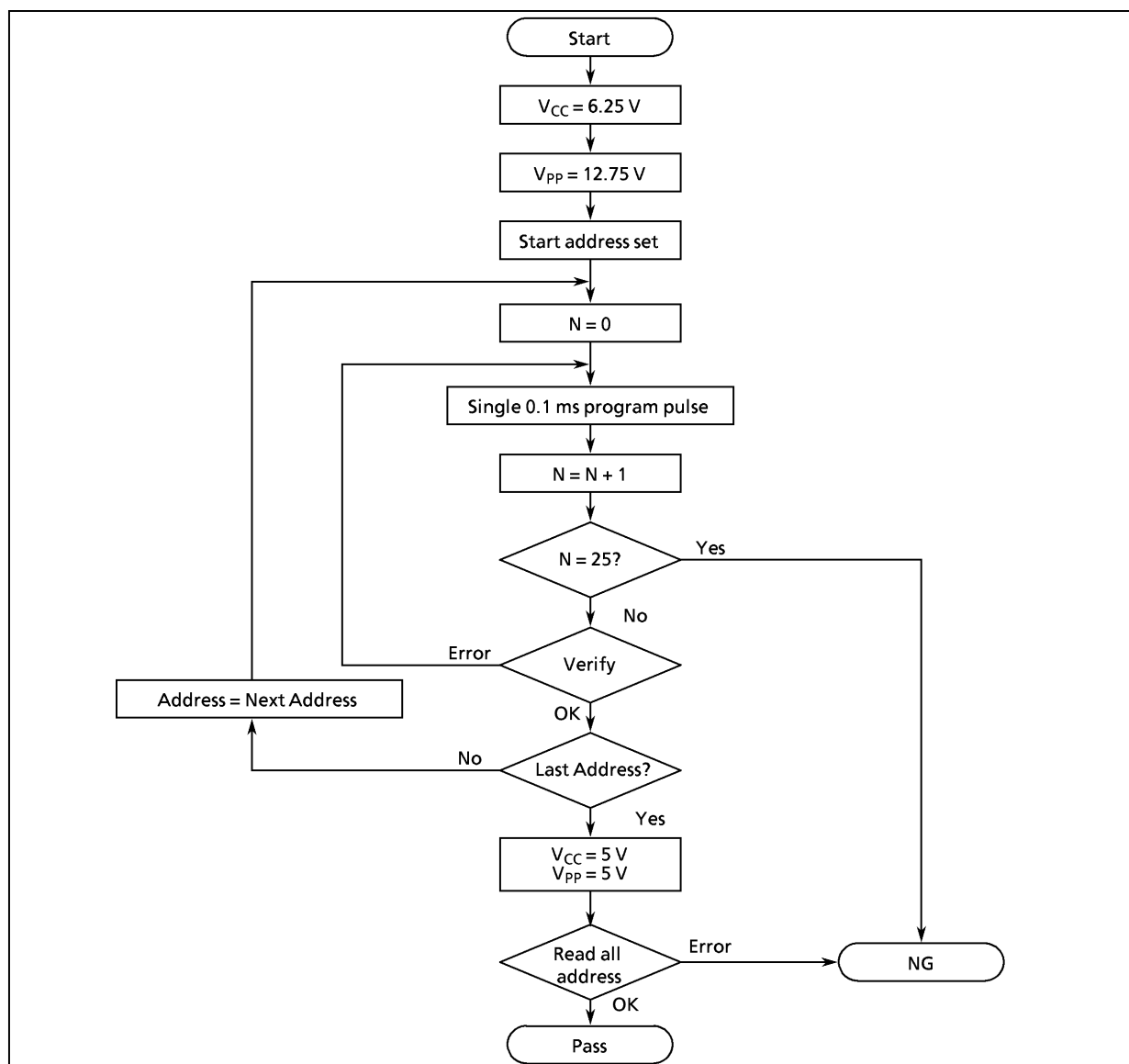

Figure 1-5. Flowchart of high-speed programming mode - II

1.2.3 Writing method for general-purpose PROM program

(1) Adapters

BM11116: TMP87P809M

BM11122: TMP87P809N

(2) Adapter setting

Switch (SW1) is set to side N.

(3) PROM programmer specifying

i) PROM type is specified to TC57256AD.

Writing voltage: 12.5 V (high-speed program I mode)

12.75 V (high-speed program II mode)

ii) Data transfer (copy) (note 1)

In TMP87P809, EPROM is within the addresses 6000 to 7FFF_H. Data is required to be transferred (copied) to the addresses where it is possible to write. The program area in MCU mode and PROM mode is referred to "Program memory area" in Figure 1-1.

Ex. In the block transfer (copy) mode, executed as below.

ROM capacity of 4KB: transferred addresses F000 to FFFF_H to addresses 7000 to 7FFF_H

ROM capacity of 8KB: transferred addresses E000 to FFFF_H to addresses 6000 to 7FFF_H

iii) Writing address is specified. (note 1)

Start address: 7000_H (ROM 8 KB: 6000_H)

End address: 7FFF_H

(4) Writing

Writing/Verifying is required to be executed in accordance with PROM programmer operating procedure.

Note 1: The specifying method is referred to the PROM programmer description. The data in addresses 0000 to 5FFF_H must be specified to FF_H.

Note 2: When MCU is set to an adapter or the adapter is set to PROM programmer, a position of pin 1 must be adjusted. If the setting is reversed, MCU, the adapter and PROM program is damaged.

Note 3: TMP87P809 does not support the electric signature mode (hereinafter referred to as "signature"). If the signature is used in PROM program, a device is damaged due to applying 12 V ± 0.5 V to the address pin 9 (A9). The signature must not be used.

Electrical Characteristics

Absolute Maximum Ratings		$(V_{SS} = 0\text{ V})$		
Parameter	Symbol	Condition	Ratings	Unit
Supply Voltage	V_{DD}		- 0.3 to 6.5	V
Program Voltage	V_{PP}	TEST/ V_{PP} pin	- 0.3 to 13.0	V
Input Voltage	V_{IN}		- 0.3 to $V_{DD} + 0.3$	V
Output Voltage	V_{OUT1}	Ports P1, P5, P6, XOUT	- 0.3 to $V_{DD} + 0.3$	
	V_{OUT2}	Port P4	- 0.3 to 5.5	V
Output Current (Per 1 pin)	IOL	I_{OUT1}	Ports P1, P6	3.2
		I_{OUT2}	Ports P4, P5	30
	IOH	I_{OUT3}	Ports P1, P5, P6	- 1.8
Output Current (Total)	IOL	ΣI_{OUT1}	Ports P1, P6	30
		ΣI_{OUT2}	Ports P4, P5	80
	IOH	ΣI_{OUT3}	Ports P1, P5, P6	30
Power Dissipation [$T_{opr} = 70^{\circ}\text{C}$]	PD		SDIP	300
			SOP	180
Soldering Temperature (time)	T_{sld}		260 (10 s)	$^{\circ}\text{C}$
Storage Temperature	T_{stg}		- 55 to 125	$^{\circ}\text{C}$
Operating Temperature	T_{opr}		- 30 to 70	$^{\circ}\text{C}$

Note: The absolute maximum ratings are rated values which must not be exceeded during operation, even for an instant. Any one of the ratings must not be exceeded. If any absolute maximum rating is exceeded, a device may break down or its performance may be degraded, causing it to catch fire or explode resulting in injury to the user. Thus, when designing products which include this device, ensure that no absolute maximum rating value will ever be exceeded.

Recommended Operating Conditions		$(V_{SS} = 0\text{ V}, T_{opr} = -30\text{ to }70^{\circ}\text{C})$				
Parameter	Symbol	Pins	Conditions	Min	Max	Unit
Supply Voltage	V_{DD}		$f_c = 8\text{ MHz}$	NORMAL mode	4.5	5.5
				IDLE mode		
			$f_c = 4.2\text{ MHz}$	NORMAL mode	2.2	
				IDLE mode		
		STOP mode	2.0			
Input High Voltage	V_{IH1}	Except hysteresis input	$V_{DD} \geq 4.5\text{ V}$	$V_{DD} \times 0.70$	V_{DD}	V
	V_{IH2}	Hysteresis input		$V_{DD} \times 0.75$		
	V_{IH3}			$V_{DD} < 4.5\text{ V}$		
Input Low Voltage	V_{IL1}	Except hysteresis input	$V_{DD} \geq 4.5\text{ V}$		$V_{DD} \times 0.30$	V
	V_{IL2}	Hysteresis input		0	$V_{DD} \times 0.25$	
	V_{IL3}			$V_{DD} < 4.5\text{ V}$	$V_{DD} \times 0.10$	
Clock Frequency	f_c	XIN, XOUT	$V_{DD} = 4.5\text{ to }5.5\text{ V}$	1.0	8.0	MHz
			$V_{DD} = 2.2\text{ V to }5.5\text{ V}$		4.2	

Note1: The recommended operating conditions for a device are operating conditions under which it can be guaranteed that the device will operate as specified. If the device is used under operating conditions other than the recommended operating conditions (supply voltage, operating temperature range, specified AC/DC values etc.), malfunction may occur. Thus, when designing products which include this device, ensure that the recommended operating conditions for the device are always adhered to.

Note2: Clock frequency f_c : Supply voltage range is specified in NORMAL mode and IDLE mode.

DC Characteristics

(V_{SS} = 0 V, Topr = -30 to 70°C)

Parameter	Symbol	Pins	Conditions	Min	Typ.	Max	Unit
Hysteresis Voltage	V _{HS}	Hysteresis input		-	0.9	-	V
Input Current	I _{IN1}	TEST	V _{DD} = 5.5 V	-	-	± 2	μA
	I _{IN2}	Tri-state ports	V _{IN} = 5.5 V / 0 V				
	I _{IN3}	RESET, STOP					
Input Resistance	R _{IN2}	RESET		100	220	450	kΩ
Output Leakage Current	I _{LO}	Tri-state ports	V _{DD} = 5.5 V, V _{OUT} = 5.5 V / 0 V	-2	-	2	μA
Output High Voltage	V _{OH2}	Tri-state ports	V _{DD} = 4.5 V, I _{OH} = -0.7 mA	4.1	-	-	V
Output Low Voltage	V _{OL1}	Except XOUT, P4 and P5	V _{DD} = 4.5 V, I _{OL} = 1.6 mA	-	-	0.4	
Output Low current	I _{OL3}	P4, P5	V _{DD} = 4.5 V, V _{OL} = 1.0 V	-	20	-	mA
Supply Current in NORMAL modes	I _{DD}		V _{DD} = 5.5 V f _c = 8 MHz		8	14	mA
Supply Current in IDLE modes			V _{IN} = 5.3 V / 0.2 V		4	6	
Supply Current in NORAML mode			V _{DD} = 3.0 V f _c = 4.2 MHz		2.5	3.5	mA
Supply Current in IDLE mode			V _{IN} = 2.8 V / 0.2 V		1.5	2.0	
Supply Current in STOP mode			V _{DD} = 5.5 V V _{IN} = 5.3 V / 0.2 V			0.5	10

Note 1: Typical values show those at Topr = 25°C, V_{DD} = 5 V.

Note 2: Input Current I_{IN1}, I_{IN3}: The current through resistor is not included, when the input resistor (pull-up or pull-down) is contained.

AD Conversion Characteristics

(V_{SS} = 0 V, V_{DD} = 2.2 to 5.5V, Topr = -30 to 70°C)

Parameter	Symbol	Conditions	Min	Typ.	Max	Unit
Analog Reference Voltage	V _{AREF}		2.2	-	V _{DD}	V
	V _{ASS}		V _{SS}			
Analog Input Voltage range	V _{AIN}		V _{ASS}	-	V _{AREF}	V
Analog Reference Current	I _{REF}	V _{AREF} = 5.5 V, V _{ASS} (V _{SS}) = 0.0 V	-	0.5	1.0	mA
Nonlinearity Error		V _{DD} = 5.0 V V _{AREF} = 5.000 V V _{ASS} (V _{SS}) = 0.000 V or V _{DD} = 2.2 V V _{AREF} = 2.200 V V _{ASS} (V _{SS}) = 0.000 V	-	-	± 2	LSB
Zero Point Error			-	-	± 2	
Full Scale Error			-	-	± 2	
Total Error			-	-	± 4	

Note: Quantizing error is not contained in those errors.

Oscillation Stop Detector Characteristics (V_{SS} = 0 V, Topr = -30 to 70°C)

Parameter	SYMBOL	Conditions	Min	Typ.	Max	Unit
Detection time	T _{CLZ}	VDD = 2.2 V to 5.5 V (fc = 2 MHz to 4.2 MHz) VDD = 4.5 V to 5.5 V (fc = 8 MHz)	2	20	400	μs

AC Characteristics

(V_{SS} = 0 V, V_{DD} = 4.5 to 5.5 V, Topr = -30 to 70°C)

Parameter	Symbol	Conditions	Min	Typ.	Max	Unit
Machine Cycle Time	tcy	In NORMAL mode	0.5	-	4	μs
		In IDLE mode				
High Level Clock Pulse Width	t _{WCH}	For external clock operation	50	-	-	ns
Low Level Clock Pulse Width	t _{WCL}	fc = 8 MHz				

Recommended Oscillating Conditions

(V_{SS} = 0 V, V_{DD} = 2.2 to 5.5 V, Topr = -30 to 70°C)

Parameter	Oscillator	Oscillation Frequency	Recommended Oscillator	Recommended Constant	
				C ₁	C ₂
High-frequency Oscillation	Ceramic Resonator	8 MHz (4.5 V to 5.5 V)	MURATA CST8.00MTW	—	
			MURATA CSA8.00MTZ	30 pF	30 pF
		4 MHz (2.2 V to 5.5 V)	MURATA CST4.00MGWU	—	
			MURATA CSA4.00MGU	30 pF	30 pF

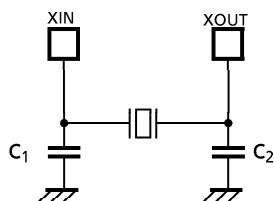

(1) High-frequency Oscillation

Note 1: When used in high electric field such as a picture tube, the package is recommended to be electrically shielded to maintain a regular operation.

Note 2: The product numbers and specifications of the resonators by Murata Manufacturing Co., Ltd. are subject to change. For up-to-date information, please refer to the following URL; <http://www.murata.co.jp/search/index.html>

(1) READ OPERATION ($T_{opr} = 0$ to 70°C)

DC Characteristics, AC Characteristics

($V_{SS} = 0\text{ V}$)

Parameter	Symbol	Conditions	Min	Typ.	Max	Unit
Input High Voltage	V_{IH4}		$V_{CC} \times 0.67$	–	V_{CC}	V
Input Low Voltage	V_{IL4}		0	–	$V_{CC} \times 0.3$	V
Supply Voltage	V_{CC}		4.75	5.00	5.25	V
Program Supply Voltage	V_{PP}		$V_{CC} - 0.6$	V_{CC}	$V_{CC} + 0.6$	
Address Set-up Time	t_{ASU}		400	–	–	ns
Address Access Time	t_{ACC}	$V_{CC} = 5.0 \pm 0.25\text{ V}$	–	5tcyc	–	ns

Note: tcyc = 400 ns

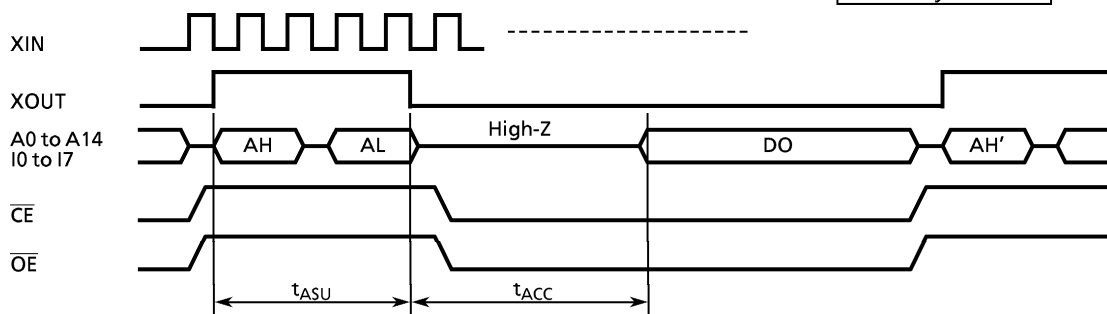

(2) Program Operation (High speed write mode - I) ($T_{opr} = 25 \pm 5^{\circ}\text{C}$)

Parameter	Symbol	Conditions	Min	Typ.	Max	Unit
Input High Voltage	V_{IH4}		$V_{CC} \times 0.7$	–	V_{CC}	V
Input Low Voltage	V_{IL4}		0	–	$V_{CC} \times 0.12$	V
Supply Voltage	V_{CC}		5.75	6.0	6.25	V
Program Supply Voltage	V_{PP}		12.0	12.5	13.0	V
Initial Program Pulse Width	t_{PW}	$V_{CC} = 6.0\text{ V} \pm 0.25\text{ V}$, $V_{PP} = 12.5\text{ V} \pm 0.25\text{ V}$	0.95	1.0	1.05	ms

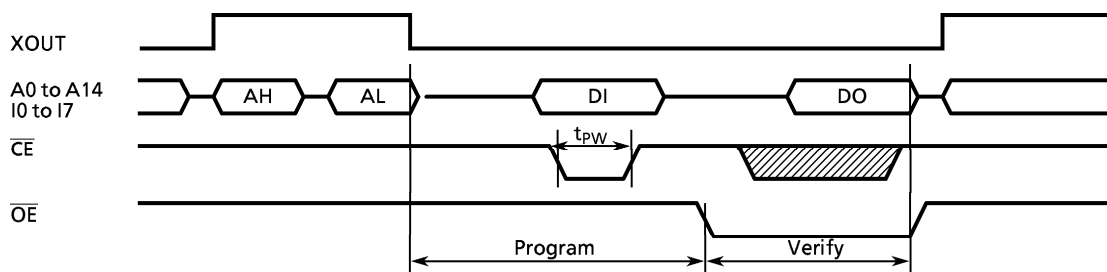

Note: DO ; Data output (I0 to I7) AL ; Address input (A0 to A7)
DI ; Data input (I0 to I7) AH ; Address input (A8 to A14)

- Note1: When V_{CC} power supply is turned on or after, V_{pp} must be increased.
When V_{CC} power supply is turned off or before, V_{pp} must be decreased.
- Note2: The device must not be set to the EPROM programmer or picked up from it under applying the program voltage ($12.5\text{ V} \pm 0.5\text{ V}$) to the V_{pp} pin as the device is damaged.
- Note3: Be sure to execute the recommended programming mode with the recommended programing adaptor. If a mode or an adaptor except the above, the misoperation sometimes occurs.

(3) Program Operation (High speed write mode -II) ($T_{opr} = 25 \pm 5^{\circ}\text{C}$)

Parameter	Symbol	Conditions	Min	Typ.	Max	Unit
Input High Voltage	V_{IH4}		$V_{CC} \times 0.7$	–	V_{CC}	V
Input Low Voltage	V_{IL4}		0	–	$V_{CC} \times 0.12$	V
Supply Voltage	V_{CC}		6.00	6.25	6.50	V
Program Supply Voltage	V_{PP}		12.50	12.75	13.0	V
Initial Program Pulse Width	t_{PW}	$V_{CC} = 6.25 \text{ V} \pm 0.25 \text{ V}$, $V_{PP} = 12.75 \text{ V} \pm 0.25 \text{ V}$	0.095	0.1	0.105	ms

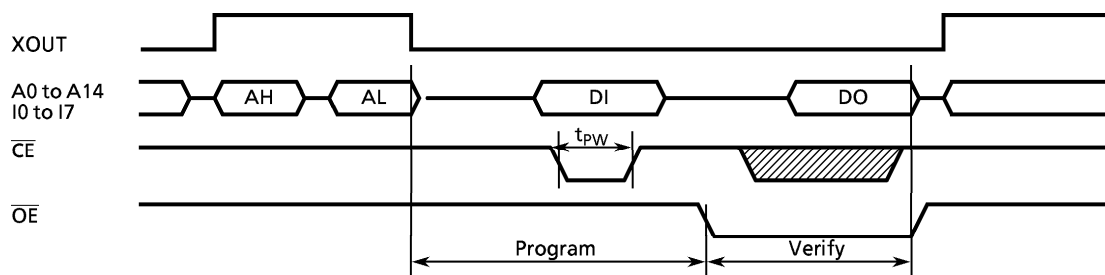

Note: DO ; Data output (I0 to I7) AL ; Address input (A0 to A7)
 DI ; Data input (I0 to I7) AH ; Address input (A8 to A14)

- Note1:** When V_{CC} power supply is turned on or after, V_{pp} must be increased.
 When V_{CC} power supply is turned off or before, V_{pp} must be decreased.
- Note2:** The device must not be set to the EPROM programmer or picked up from it under applying the program voltage ($12.5 \text{ V} \pm 0.5 \text{ V}$) to the V_{pp} pin as the device is damaged.
- Note3:** Be sure to execute the recommended programming mode with the recommended programming adaptor. If a mode or an adaptor except the above, the misoperation sometimes occurs.