

WLED Driver for Notebooks with PWM Interface and Auto Phase Shift

Check for Samples: [TPS61187](#)

FEATURES

- 4.5 V to 24 V Input Voltage
- 38 V Maximum Output Voltage
- Integrated 2 A 40 V MOSFET
- 300 kHz to 1 MHz Programmable Switching Frequency
- Adaptive Boost Output to WLED Voltages
- Wide PWM Dimming Frequency Range
 - 100 Hz to 50 KHz for Direct PWM Mode
 - 100 Hz to 22 KHz for Frequency Programmable Mode
- 100:1 Dimming Ratio at 20 kHz
- 10000:1 Dimming Ratio at 200 Hz (Direct PWM mode)
- Small External Components
- Integrated Loop Compensation
- Six Current Sinks of 30 mA Max
- 1.5% (Typ) Current Matching
- PWM Brightness Interface Control
- PWM Phase Shift Mode Brightness Dimming Method or Direct PWM Dimming Method
- 4 kV HBM ESD Protection
- Programmable Over Voltage Threshold
- Built-in WLED Open/Short Protection
- Thermal Shutdown
- 20 Lead 4mm x 4mm x 0.8 mm TQFN Package

APPLICATIONS

- Notebook LCD Display Backlight

DESCRIPTION

The TPS61187 IC provides a highly integrated WLED driver solution for notebook LCD backlight. This device has a built-in high efficiency boost regulator with integrated 2.0A /40V power MOSFET. The six current sink regulators provide high precision current regulation and matching. In total, the device can support up to 60 WLEDs. In addition, the boost output automatically adjusts its voltage to the WLED forward voltage to optimize efficiency.

The TPS61187 supports the auto phase shift dimming method and direct PWM dimming method. During phase shift PWM dimming, the WLED current is turned on/off at the duty cycle controlled by the input PWM signal and each channel is shifted according to the frequency determined by an integrated pulse width modulation (PWM) signal. The frequency of this signal is resistor programmable, while the duty cycle is controlled directly from an external PWM signal input to the PWM pin. During direct PWM dimming, the WLED current is turned on/off synchronized with the input PWM signal.

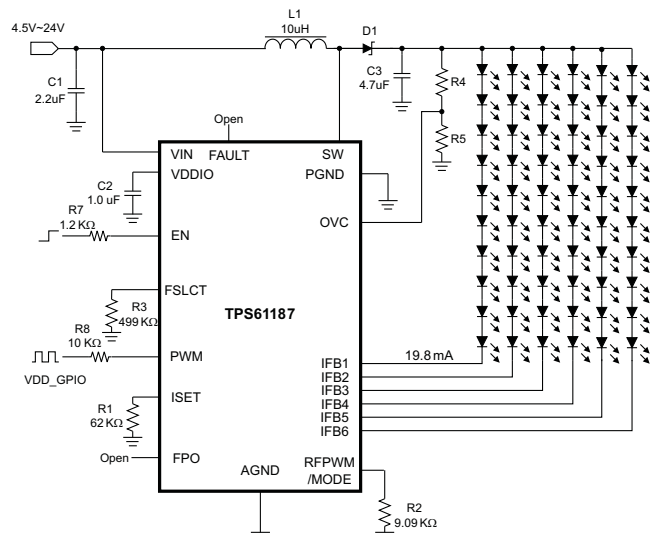

Figure 1. Typical Application – Phase Shift PWM Mode



Please be aware that an important notice concerning availability, standard warranty, and use in critical applications of Texas Instruments semiconductor products and disclaimers thereto appears at the end of this data sheet.



These devices have limited built-in ESD protection. The leads should be shorted together or the device placed in conductive foam during storage or handling to prevent electrostatic damage to the MOS gates.

PACKAGE INFORMATION⁽¹⁾

PACKAGE	PACKAGE MARKING
TPS61187RTJ	TPS61187

- (1) For the most current package and ordering information, see the Package Option Addendum at the end of this document, or see the TI website at www.ti.com.

ABSOLUTE MAXIMUM RATINGS

over operating free-air temperature range (unless otherwise noted) ⁽¹⁾

		VALUE		UNIT
		MIN	MAX	
Voltage range ⁽²⁾	VIN, FAULT	-0.3	24	V
	FPO	-0.3	7	V
	SW	-0.3	40	V
	EN, PWM, IFB1 to IFB4	-0.3	20	V
	VDDIO	-0.3	3.7	V
	All other pins	-0.3	3.6	V
HBM ESD rating			4	kV
MM ESD rating			200	V
CDM ESD rating			1.5	kV
Continuous power dissipation		See Thermal Information Table		
Operating junction temperature range		-40	150	°C
Storage temperature range		-65	150	°C

- (1) Stresses beyond those listed under *absolute maximum ratings* may cause permanent damage to the device. These are stress ratings only, and functional operation of the device at these or any other conditions beyond those indicated under *recommended operating conditions* is not implied. Exposure to absolute-maximum-rated conditions for extended periods may affect device reliability.
- (2) All voltage values are with respect to network ground terminal.

RECOMMENDED OPERATING CONDITIONS

over operating free-air temperature range (unless otherwise noted)

		MIN	NOM	MAX	UNIT
V _{IN}	Input voltage range	4.5		24	V
V _{OUT}	Output voltage range	V _{IN}		38	V
L1	Inductor, 600 kHz ~ 1 MHz switching frequency	10		22	μH
L1	Inductor, 300 kHz ~ 600 kHz switching frequency	22		47	μH
C _I	Input capacitor	1			μF
C _O	Output capacitor	1.0	4.7	10	μF
F _{PWM_O}	IFBx PWM dimming frequency - frequency programmable mode	0.1		22 ⁽¹⁾	KHz
F _{PWM_O}	IFBx PWM dimming frequency - direct PWM mode	0.1		50	KHz
F _{PWM_I}	PWM input signal frequency	0.1		22	KHz
F _{BOOST}	Boost regulator switching frequency	300		1000	KHz
T _A	Operating free-air temperature	-40		85	°C
T _J	Operating junction temperature	-40		125	°C

- (1) 5 μs min pulse on time.

THERMAL INFORMATION

THERMAL METRIC ⁽¹⁾		TPS61187			
		RTJ			
		20			
			UNITS		
θ_{JA}	Junction-to-ambient thermal resistance		39.9		°C/W
$\theta_{JC(top)}$	Junction-to-case(top) thermal resistance		34.0		
θ_{JB}	Junction-to-board thermal resistance		9.9		
ψ_{JT}	Junction-to-top characterization parameter		0.6		
ψ_{JB}	Junction-to-board characterization parameter		9.5		
$\theta_{JC(bottom)}$	Junction-to-case(bottom) thermal resistance		2		

(1) For more information about traditional and new thermal metrics, see the *IC Package Thermal Metrics* application report, [SPRA953](#).

ELECTRICAL CHARACTERISTICS

$V_{IN} = 12V$, PWM/EN = high, IFB current = 20mA, IFB voltage = 500mV, $T_A = -40^{\circ}C$ to $85^{\circ}C$, typical values are at $T_A = 25^{\circ}C$ (unless otherwise noted)

PARAMETER		TEST CONDITIONS	MIN	TYP	MAX	UNIT
SUPPLY CURRENT						
V_{IN}	Input voltage range		4.5		24	V
I_{q_VIN}	Operating quiescent current into V_{in}	Device enable, switching 1MHz and no load, $V_{IN} = 24V$			4.0	mA
VDDIO	VDDIO pin output voltage	$I_{load} = 5mA$	3.0	3.3	3.6	V
I_{SD}	Shutdown current	$V_{IN} = 12V$, EN = low			11	μA
		$V_{IN} = 24V$, EN = low			16	
V_{IN_UVLO}	V_{IN} under-voltage lockout threshold	V_{IN} ramp down			3.50	V
		V_{IN} ramp up			3.75	
V_{IN_Hys}	V_{IN} under-voltage lockout hysteresis			250		mV
PWM						
V_H	EN Logic high threshold	EN	2.1			V
V_L	EN Logic low threshold	EN			0.8	
V_H	PWM Logic high threshold	PWM	2.1			
V_L	PWM Logic low threshold	PWM			0.8	
R_{PD}	Pull down resistor on PWM and EN		400	800	1600	k Ω
CURRENT REGULATION						
V_{ISET}	ISET pin voltage		1.204	1.229	1.253	V
K_{ISET}	Current multiplier			980		
I_{FB}	Current accuracy	$I_{ISET} = 20\mu A$, $0^{\circ}C$ to $70^{\circ}C$	-2%		2%	
		$I_{ISET} = 20\mu A$, $-40^{\circ}C$ to $85^{\circ}C$	-2.3%		2.3%	
K_m	$(I_{max} - I_{min}) / I_{AVG}$	$I_{ISET} = 20\mu A$		1.3%		
I_{leak}	IFB pin leakage current	IFB voltage = 15 V, each pin		2	5	μA
		IFB voltage = 5 V, each pin		1	2	
I_{IFB_max}	Current sink max output current	IFB = 350 mV	30			mA
f_{dim}	PWM dimming frequency	$R_{FPWM} = 9.09k\Omega$		20		kHz
BOOST OUTPUT REGULATION						
V_{IFB_L}	Output voltage up threshold	Measured on $V_{IFB(min)}$		350		mV
V_{IFB_H}	Output voltage down threshold	Measured on $V_{IFB(min)}$		650		mV
POWER SWITCH						
R_{PWM_SW}	PWM FET on-resistance	$V_{IN} = 12V$		0.25	0.35	Ω
I_{LN_NFET}	PWM FET leakage current	$V_{SW} = 40V$, $T_A = 25^{\circ}C$			2	μA

ELECTRICAL CHARACTERISTICS (continued)

$V_{IN} = 12V$, PWM/EN = high, IFB current = 20mA, IFB voltage = 500mV, $T_A = -40^{\circ}C$ to $85^{\circ}C$, typical values are at $T_A = 25^{\circ}C$ (unless otherwise noted)

PARAMETER		TEST CONDITIONS	MIN	TYP	MAX	UNIT
OSCILLATOR						
f_S	Oscillator frequency	$R_{FSW} = 499\text{ k}\Omega$	0.8	1.0	1.2	MHz
D_{max}	Maximum duty cycle	IFB = 0	94%			
OC, SC, OVP AND SS						
I_{LIM}	N-Channel MOSFET current limit	$D = D_{max}$	2.0		3.0	A
V_{CLAMP_TH}	Output voltage clamp program threshold		1.90	1.95	2.00	V
V_{OVP_IFB}	IFB overvoltage threshold	Measured on the IFBx pin, IFB on	12	13.5	15	V
FPO, FAULT						
V_{FPO_L}	FPO Logic low voltage	$I_{SOURCE} = 0.5\text{ mA}$			0.4	V
V_{FAULT_HIGH}	Fault high voltage	Measured as $V_{IN} - V_{FAULT}$		0.1		V
V_{FAULT_LOW}	Fault low voltage	Measured as $V_{IN} - V_{FAULT}$, Sink, 10 μA	6	8	10	V
I_{FAULT}	Maximum sink current	$V_{IN} - V_{FAULT} = 0\text{ V}$		20		μA
THERMAL SHUTDOWN						
$T_{shutdown}$	Thermal shutdown threshold			150		$^{\circ}C$
	Thermal shutdown hysteresis			15		

DEVICE INFORMATION

**20 PIN 4mm × 4mm RTJ PACKAGE
TOP VIEW**

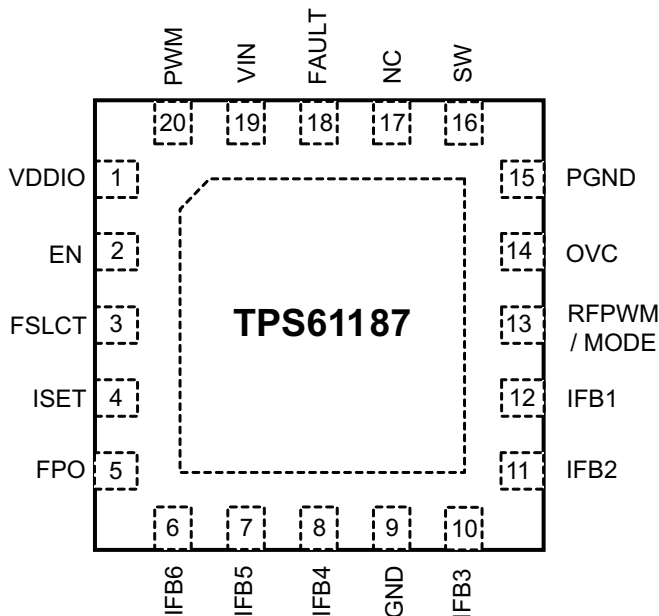

PowerPAD information goes here.

PIN FUNCTIONS

PIN		DESCRIPTION
NAME	NO.	
VDDIO	1	Internal pre_regulator. Connect a 1.0 μ F ceramic capacitor to VDDIO.
EN	2	Enable
FSLCT	3	Switching frequency selection pin. Use a resistor to set the frequency between 300kHz to 1.0MHz
ISET	4	Full-scale LED current set pin. Connecting a resistor to the pin programs the current level.
FPO	5	Fault protection output to indicate fault conditions including OVP, OC, and OT
IFB1 to IFB6	6,7,8, 10,11,12	Regulated current sink input pins
GND	9	Analog ground
RFPWM / MODE	13	Dimming frequency program pin with an external resistor / mode selection, see ⁽¹⁾
OVC	14	Over-voltage clamp pin / voltage feedback, see ⁽¹⁾
PGND	15	Power ground
SW	16	Drain connection of the internal power FET
NC	17	No connection
FAULT	18	Fault pin to drive external ISO FET
VIN	19	Supply input pin
PWM	20	PWM signal input pin

(1) See Application Information section for details.

TYPICAL CHARACTERISTICS

TABLE OF GRAPHS

TITLE	DESCRIPTION	FIGURE
Efficiency vs Load current by output voltage	$V_{IN} = 12\text{ V}$, $V_{OUT} = 28\text{ V}$, 32 V , 36 V , $L = 10\text{ }\mu\text{H}$	Figure 2
Efficiency vs Load current by input voltage	$V_{OUT} = 32\text{ V}$, $V_{IN} = 8\text{ V}$, 12 V , 24 V , $L = 10\text{ }\mu\text{H}$	Figure 3
Efficiency vs PWM duty	$V_{OUT} = 32\text{ V}$, $V_{IN} = 8\text{ V}$, 12 V , 24 V , $F_{DIM} = 200\text{ Hz}$, $L = 10\text{ }\mu\text{H}$, $R_{ISET} = 62\text{ k}\Omega$	Figure 4
Dimming linearity	$V_{OUT} = 32\text{ V}$, $V_{IN} = 8\text{ V}$, 12 V , 24 V , $F_{DIM} = 20\text{ KHz}$, $L = 10\text{ }\mu\text{H}$, $R_{ISET} = 62\text{ k}\Omega$	Figure 5
Dimming linearity	$V_{OUT} = 32\text{ V}$, $V_{IN} = 8\text{ V}$, 12 V , 24 V , $F_{DIM} = 200\text{ Hz}$, $L = 10\text{ }\mu\text{H}$, $R_{ISET} = 62\text{ k}\Omega$	Figure 6
Boost switching frequency	$V_{IN} = 12\text{ V}$, $V_{OUT} = 33.8\text{ V}$, $L = 10\text{ }\mu\text{H}$, $R_{ISET} = 62\text{ k}\Omega$	Figure 7
Phase shift dimming frequency	$V_{IN} = 12\text{ V}$, $V_{OUT} = 33.8\text{ V}$, $L = 10\text{ }\mu\text{H}$, $R_{ISET} = 62\text{ k}\Omega$	Figure 8
Switch waveform	$V_{IN} = 8\text{ V}$, $V_{OUT} = 33.8\text{ V}$, $F_{DIM} = 20\text{ kHz}$, Duty = 100%, $L = 10\text{ }\mu\text{H}$, $R_{ISET} = 62\text{ k}\Omega$	Figure 9
Switch waveform	$V_{IN} = 12\text{ V}$, $V_{OUT} = 33.8\text{ V}$, $F_{DIM} = 20\text{ kHz}$, Duty = 100%, $L = 10\text{ }\mu\text{H}$, $R_{ISET} = 62\text{ k}\Omega$	Figure 10
Phase shift PWM dimming $F_{DIM} = 200\text{Hz}$, duty = 50%	$V_{IN} = 12\text{ V}$, $V_{OUT} = 33.8\text{ V}$, $F_{DIM} = 20\text{ kHz}$, Duty = 45%, $L = 10\text{ }\mu\text{H}$, $R_{ISET} = 62\text{ k}\Omega$	Figure 11
Phase shift PWM dimming $F_{DIM} = 20\text{KHz}$, duty = 50%	$V_{IN} = 12\text{ V}$, $V_{OUT} = 33.8\text{ V}$, $F_{DIM} = 20\text{ kHz}$, Duty = 51%, $L = 10\text{ }\mu\text{H}$, $R_{ISET} = 62\text{ k}\Omega$	Figure 12
Output ripple of Phase shift PWM dimming	$V_{IN} = 12\text{ V}$, $V_{OUT} = 33.8\text{ V}$, $F_{DIM} = 20\text{ kHz}$, Duty = 50%, $L = 10\text{ }\mu\text{H}$, $R_{ISET} = 62\text{ k}\Omega$	Figure 13
Output ripple of Phase shift PWM dimming	$V_{IN} = 12\text{ V}$, $V_{OUT} = 33.8\text{ V}$, $F_{DIM} = 20\text{ kHz}$, Duty = 70%, $L = 10\text{ }\mu\text{H}$, $R_{ISET} = 62\text{ k}\Omega$	Figure 14
Start up waveform	$V_{IN} = 12\text{ V}$, $V_{OUT} = 33.8\text{ V}$, $F_{DIM} = 20\text{ kHz}$, Duty = 100%, $L = 10\text{ }\mu\text{H}$, $R_{ISET} = 62\text{ k}\Omega$	Figure 15
Start up waveform	$V_{IN} = 12\text{ V}$, $V_{OUT} = 33.8\text{ V}$, $F_{DIM} = 20\text{ kHz}$, Duty = 50%, $L = 10\text{ }\mu\text{H}$, $R_{ISET} = 62\text{ k}\Omega$	Figure 16

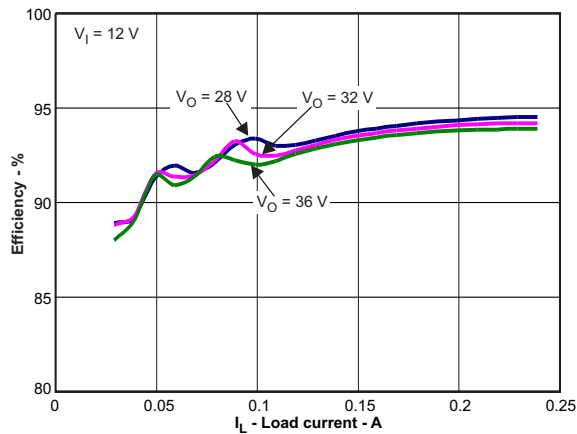

Figure 2. Efficiency

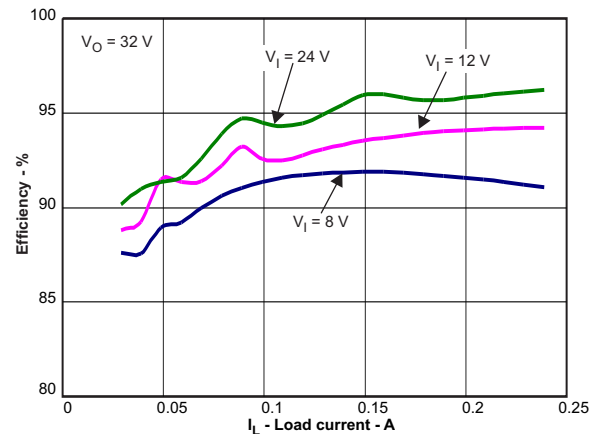

Figure 3. Efficiency

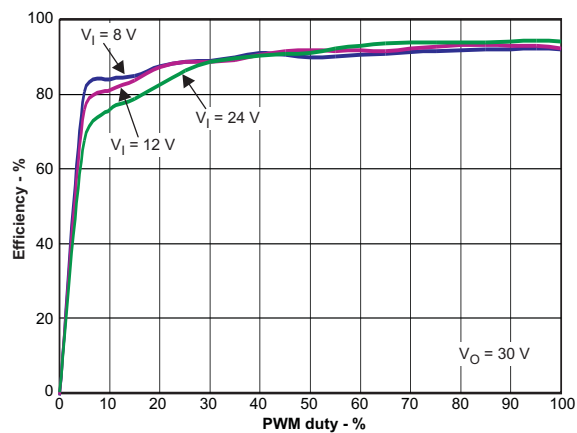

Figure 4. Efficiency

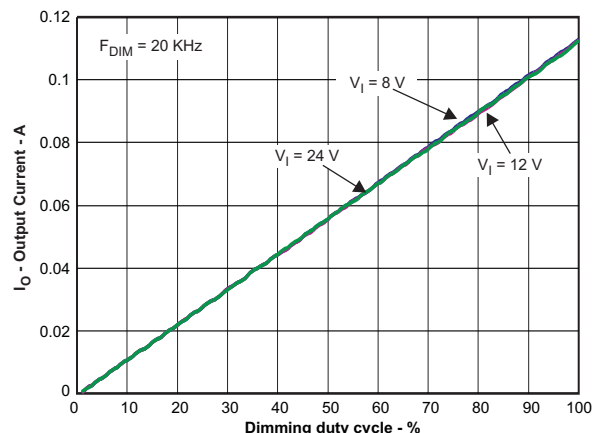

Figure 5. Output Current

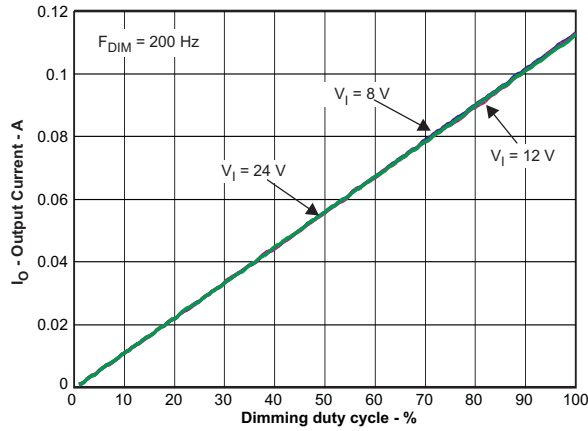

Figure 6. Output Current

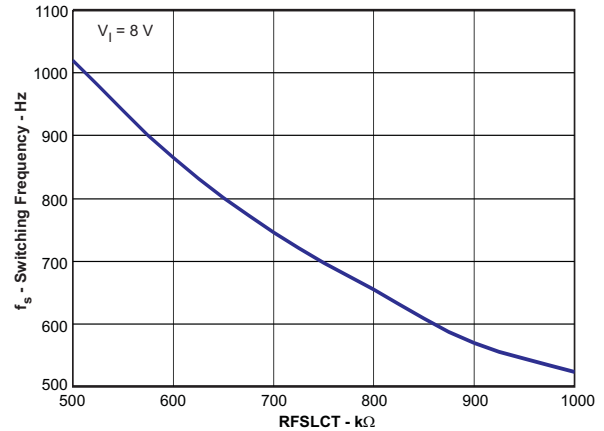

Figure 7. Switching Frequency

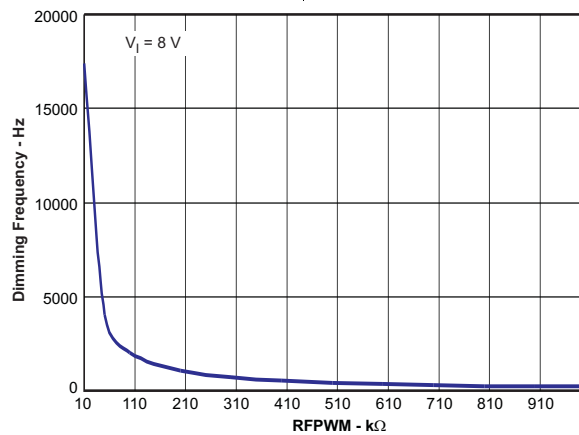

Figure 8. Dimming Frequency

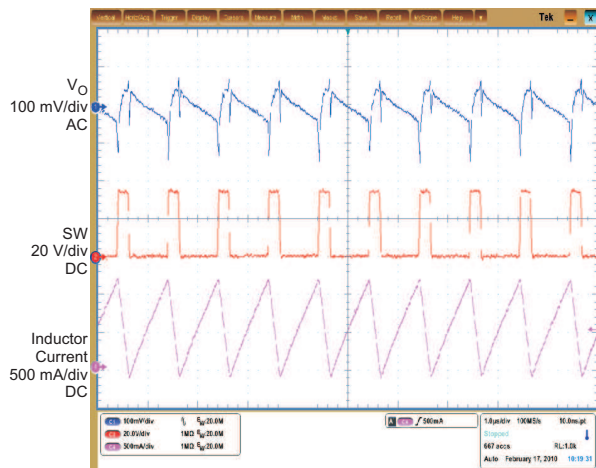

Figure 9. Switch Waveform

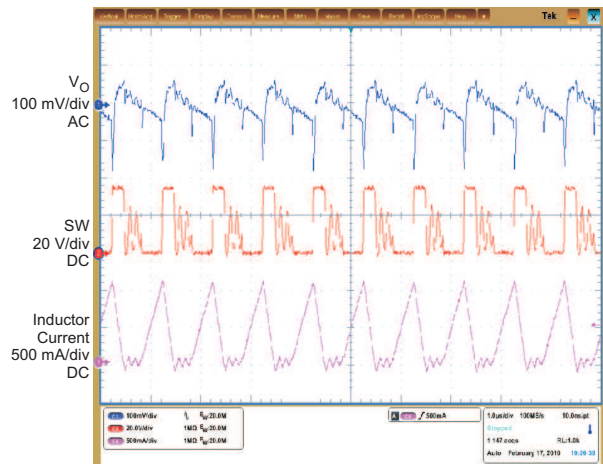

Figure 10. Switch Waveform

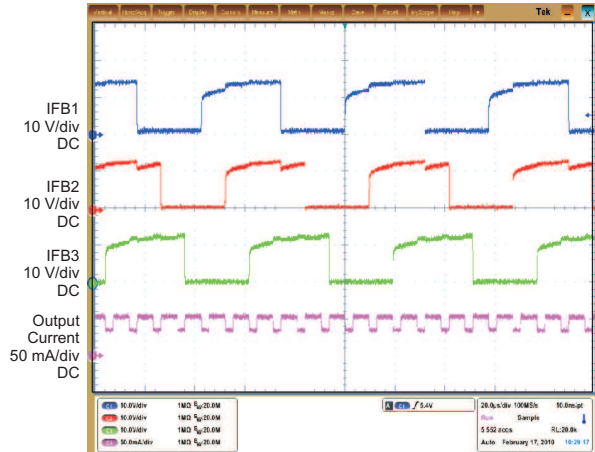

Figure 11. Phase Shift Waveform

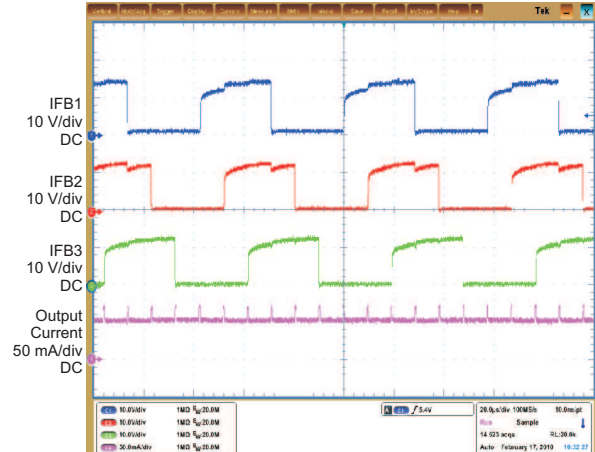

Figure 12. Phase Shift Waveform

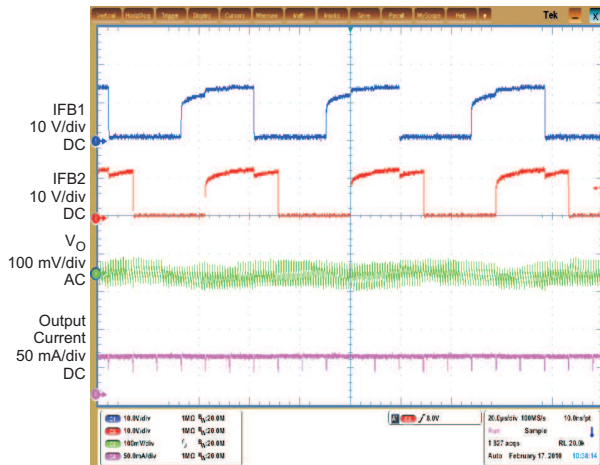

Figure 13. Output Ripple Waveform

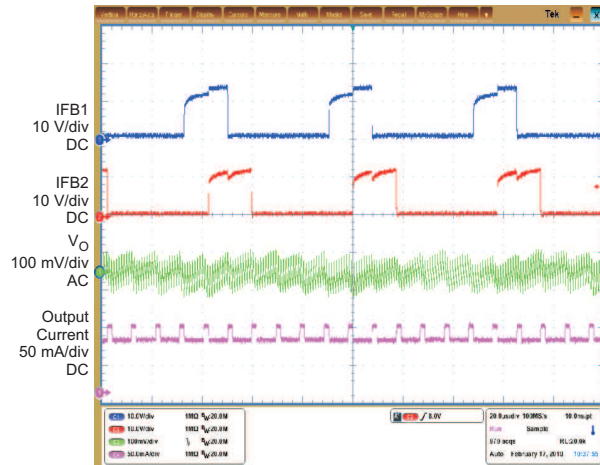

Figure 14. Output Ripple Waveform



Figure 15. Start Up Waveform

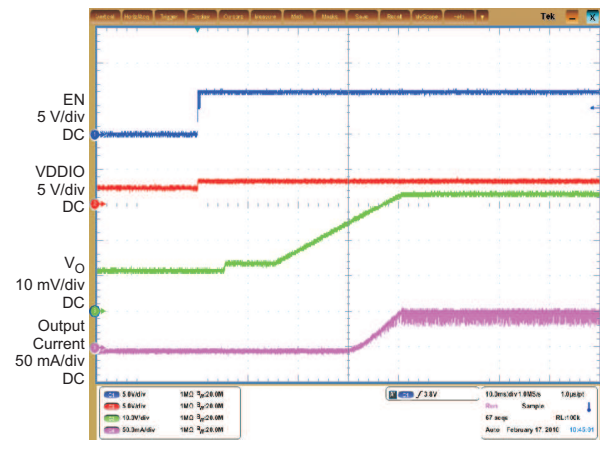
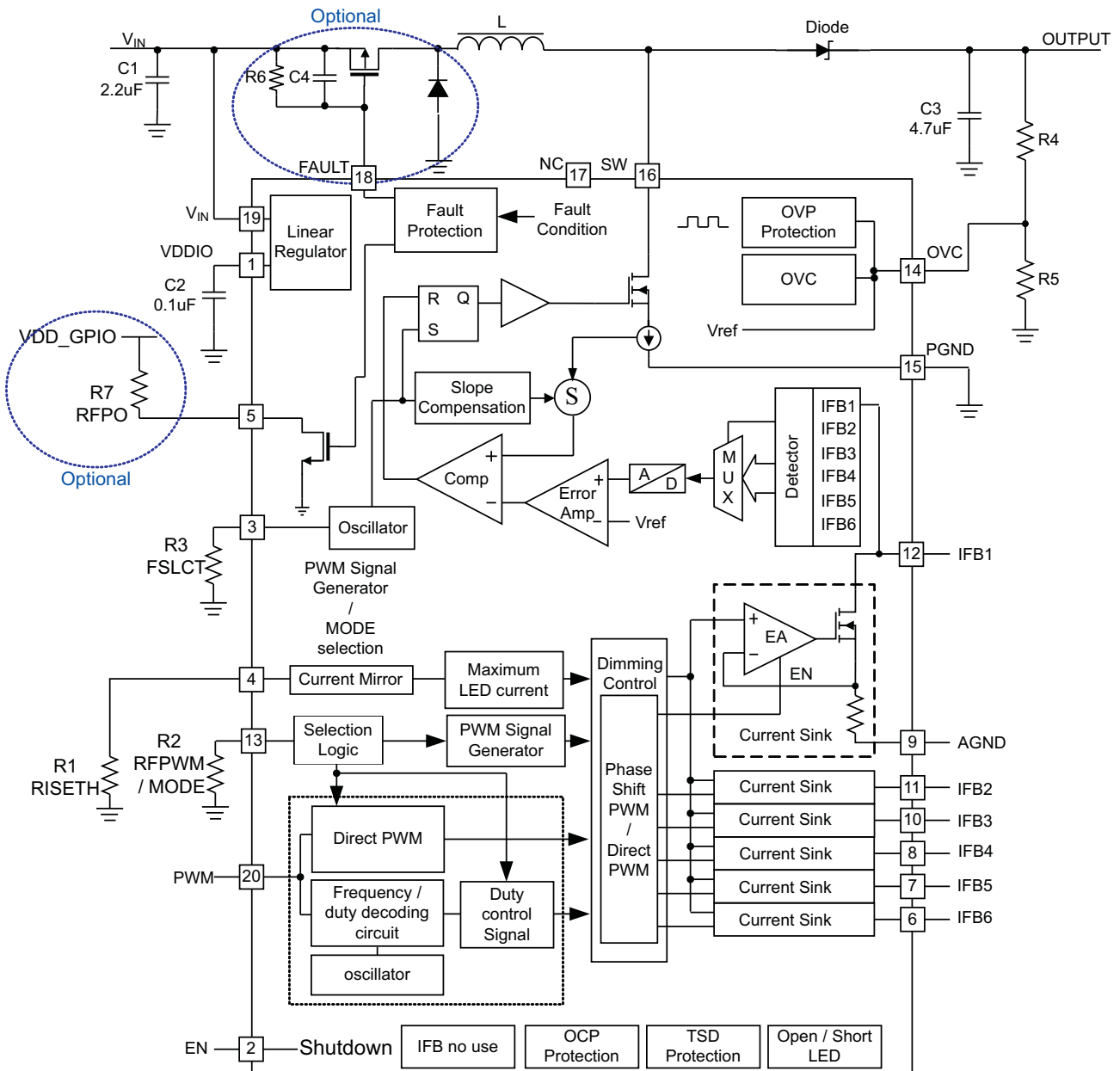

Figure 16. Start Up Waveform

FUNCTIONAL BLOCK DIAGRAM



DETAILED DESCRIPTION

NORMAL OPERATION

The TPS61187 is a high efficiency, high output voltage white LED driver for notebook panel backlighting applications. The advantages of white LEDs compared to CCFL backlights are higher power efficiency and lower profile design. Due to the large number of white LEDs required to provide backlighting for medium to large display panels, the LEDs must be arranged in parallel strings of several LEDs in series. Therefore, the backlight driver for battery powered systems is almost always a boost regulator with multiple current sink regulators. Having more white LEDs in series reduces the number of parallel strings and therefore improves overall current matching. However, the efficiency of the boost regulator declines due to the need for high output voltage. Also, there must be enough white LEDs in series to ensure the output voltage stays above the input voltage range.

The TPS61187 IC has integrated all of the key function blocks to power and control up to 60 white LEDs. The device includes a 40 V / 2 A boost regulator, six 30 mA current sink regulators, and a protection circuit for over-current, over-voltage, Open LED, Short LED, and output short circuit failures.

The TPS61187 integrates auto phase shifted PWM dimming methods with the PWM interface to reduce the output ripple voltage and audible noise. An optional direct PWM mode is user selectable through the MODE selection function.

SUPPLY VOLTAGE

The TPS61187 IC has a built-in linear regulator to supply the IC analog and logic circuit. The VDDIO pin, output of the regulator, is connected to a 1 μ F bypass capacitor for the regulator to be controlled in a stable loop. VDDIO does not have high current sourcing capability for external use but it can be tied to the EN pin for start up.

BOOST REGULATOR AND PROGRAMMABLE SWITCH FREQUENCY (F_{SW})

The fixed-frequency PWM boost converter uses current-mode control and has integrated loop compensation. The internal compensation ensures stable output over the full input and output voltage ranges assuming the recommended inductance and output capacitance values shown in the Typical Application – Phase Shift PWM Mode figure are used. The output voltage of the boost regulator is automatically set by the IC to minimize voltage drop across the IFB pins. The IC regulates the lowest IFB pin to 350 mV, and consistently adjusts the boost output voltage to account for any changes in LED forward voltages. If the input voltage is higher than the sum of the white LED forward voltage drops (e.g., at low duty cycles), the boost converter is not able to regulate the output due to its minimum duty cycle limitation. In this case, increase the number of WLEDs in series or include series ballast resistors in order to provide enough headroom for the converter to boost the output voltage. Since the TPS61187 integrates a 2.0A/40V power MOSFET, the boost converter can provide up to a 38 V output voltage.

The TPS61187 switching frequency can be programmed between 300 kHz to 1.0MHz by the resistor value on the FSLCT pin according to [Equation 1](#):

$$F_{SW} = \frac{5 \times 10^{11}}{R_{FSLCT}} \quad (1)$$

Where: R_{FSLCT} = FSLCT pin resistor

See [Figure 7](#) for boost converter switching frequency adjustment resistor R_{FSLCT} selection.

The adjustable switching frequency feature provides the user with the flexibility of choosing a faster switching frequency, and therefore, an inductor with smaller inductance and footprint or slower switching frequency, and therefore, potentially higher efficiency due to lower switching losses. Use [Equation 1](#) or refer to [Table 1](#) to select the correct value:

Table 1. R_{FSLCT} Recommendations

R_{FLCT}	F_{SW}
833K	600 KHz
625K	800 KHz
499K	1 MHz

LED CURRENT SINKS

The six current sink regulators embedded in the TPS61187 can be collectively configured to provide up to a maximum of 30 mA each. These six specialized current sinks are accurate to within $\pm 2\%$ max for currents at 20 mA, with a string-to-string difference of $\pm 1.5\%$ typical.

The IFB current must be programmed to the highest WLED current expected using the ISETH pin resistor and [Equation 2](#).

$$I_{FB} = \frac{V_{ISETH}}{R_{ISETH}} \times K_{ISET} \quad (2)$$

Where:

$$\begin{aligned} K_{ISET} &= 980 \text{ (current multiple)} \\ V_{ISETH} &= 1.229\text{V (ISETH pin voltage)} \\ R_{ISETH} &= \text{ISETH pin resistor} \end{aligned}$$

ENABLE AND STARTUP

The internal regulator which provides VDDIO wakes up as soon as V_{IN} is applied even when EN is low. This allows the IC to start when EN is tied to the VDDIO pin. VDDIO does not come to full regulation until EN is high. The TPS61187 checks the status of all current feedback channels and shuts down any unused feedback channels. It is recommended to short the unused channels to ground for faster startup.

After the device is enabled, if the PWM pin is left floating, the output voltage of the TPS61187 regulates to the minimum output voltage. Once the IC detects a voltage on the PWM pin, the TPS61187 begins to regulate the IFB pin current, as pre-set per the ISETH pin resistor, according to the duty cycle of the signal on the PWM pin. The boost converter output voltage rises to the appropriate level to accommodate the sum of the white LED string with the highest forward voltage drops plus the headroom of the current sink at that current.

Pulling the EN pin low shuts down the IC, resulting in the IC consuming less than 11 μA in shutdown mode.

IFB PIN UNUSED

The TPS61187 has open/short string detection. For an unused IFB string, simply short it to ground or leave it open. Shorting unused IFB pins to ground for faster startup is recommended.

BRIGHTNESS DIMMING CONTROL

The TPS61187 has auto phase shifted PWM dimming control with the PWM control interface.

The internal decoder block detects duty information from the input PWM signal, saves it in an eight bit register and delivers it to the output PWM dimming control circuit. The output PWM dimming control circuit turns on/off six output current sinks at the PWM frequency set by RFPWM and the duty cycle from the decoder block.

The TPS61187 also has direct PWM dimming control with the PWM control interface. In direct PWM mode, each current sink turns on/off at the same frequency and duty cycle as the input PWM signal. See the *Mode Selection* section for dimming mode selection.

When in phase shifted PWM mode, it is recommended to insert a series resistor of 10k Ω to 20k Ω value close to PWMIN pin. This resistor together with an internal capacitor forms a low pass R-C filter with 30ns to 60ns time constant. This prevents possible high frequency noises being coupled into the input PWM signal and causing interference to the internal duty cycle decoding circuit. However, it is not necessary for direct PWM mode since the duty cycle decoding circuit is disabled during the direct PWM mode.

ADJUSTBLE PWM DIMMING FREQUENCY AND MODE SELECTION (R_FPWM / MODE)

The TPS61187 can operate in auto phase shift mode or direct PWM mode. Tying the RFPWM/MODE pin to VDDIO forces the IC to operate in direct PWM mode. A resistor between the RFPWM/MODE pin and ground sets the IC into auto phase shift mode and the value of the resistor determines the PWM dimming frequency. Use [Equation 3](#) or refer to [Table 2](#) to select the correct value:

$$F_{DIM} = \frac{1.818 \times 10^8}{R_{FPWM}} \quad (3)$$

Where: R_{FPWM} = RFPWM pin resistor

Table 2. R_{FPWM} Recommendations

R_{FPWM}	F_{DIM}
866 k Ω	210 Hz
432 k Ω	420 Hz
174 k Ω	1.05 kHz
9.09 k Ω	20 kHz

MODE SELECTION – PHASE SHIFT PWM OR DIRECT PWM DIMMING

The phase shift PWM dimming method or direct PWM dimming method can be selected through the RFPWM pin. By attaching an external resistor to the RFPWM pin, the default phase shift PWM mode can be selected. To select direct PWM mode, the RFPWM pin needs to be tied to the VDDIO pin. The RFPWM/MODE pin can be noise sensitive when R2 has high impedance. In this case, careful layout or a parallel bypassing capacitor improves noise sensitivity but the value of the parallel capacitor may not exceed 33 pF for oscillator stability.

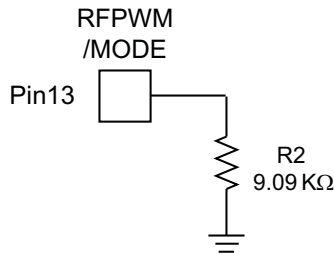

Figure 17. Phase Shift PWM Dimming Mode Selection

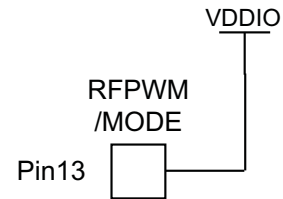

Figure 18. Direct PWM Dimming Mode Selection

PHASE SHIFT PWM DIMMING

In phase shift PWM mode, all current feedback channels are turned on and off at F_{DIM} frequency with a constant delay. However, the number of used channels and PWM dimming frequency determine the delay time between two neighboring channels per Equation 4.

$$T_{\text{delay}} = \frac{1}{n \times F_{DIM}} \tag{4}$$

Where: n is the number of used channels

F_{DIM} is the PWM dimming frequency which is determined by the value of R_{FPWM} on the RFPWM pin. Figure 19 provides the detailed timing diagram of the phase shift PWM dimming mode.

In phase shift PWM mode, the internal decoder converts the duty cycle information from the applied PWM signal at the PWM pin into an 8-bit digital signal and stores it into a register. The integrated dimming control circuit reconstructs the PWM duty cycle per the register value and sends it to each of the current sinks. In order to avoid any flickering while the duty cycle information is reconstructed from the register, one LSB (1/256) of duty cycle hysteresis is included which results in 1/256 resolution when incrementing the applied signal's duty cycle but 2/256 resolution when decrementing the duty cycle.

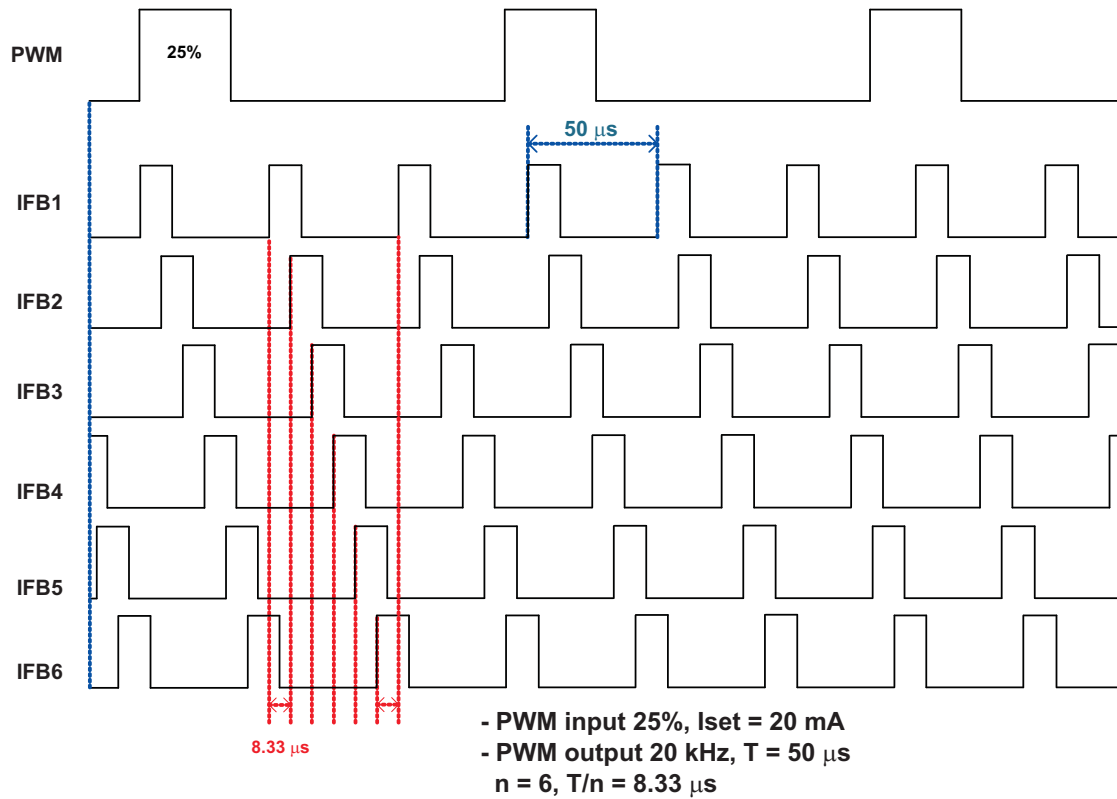

Figure 19. Phase Shift PWM Dimming Timing Diagram

DIRECT PWM DIMMING

In direct PWM mode, all current feedback channels are turned on and off and are synchronized with the input PWM signal.

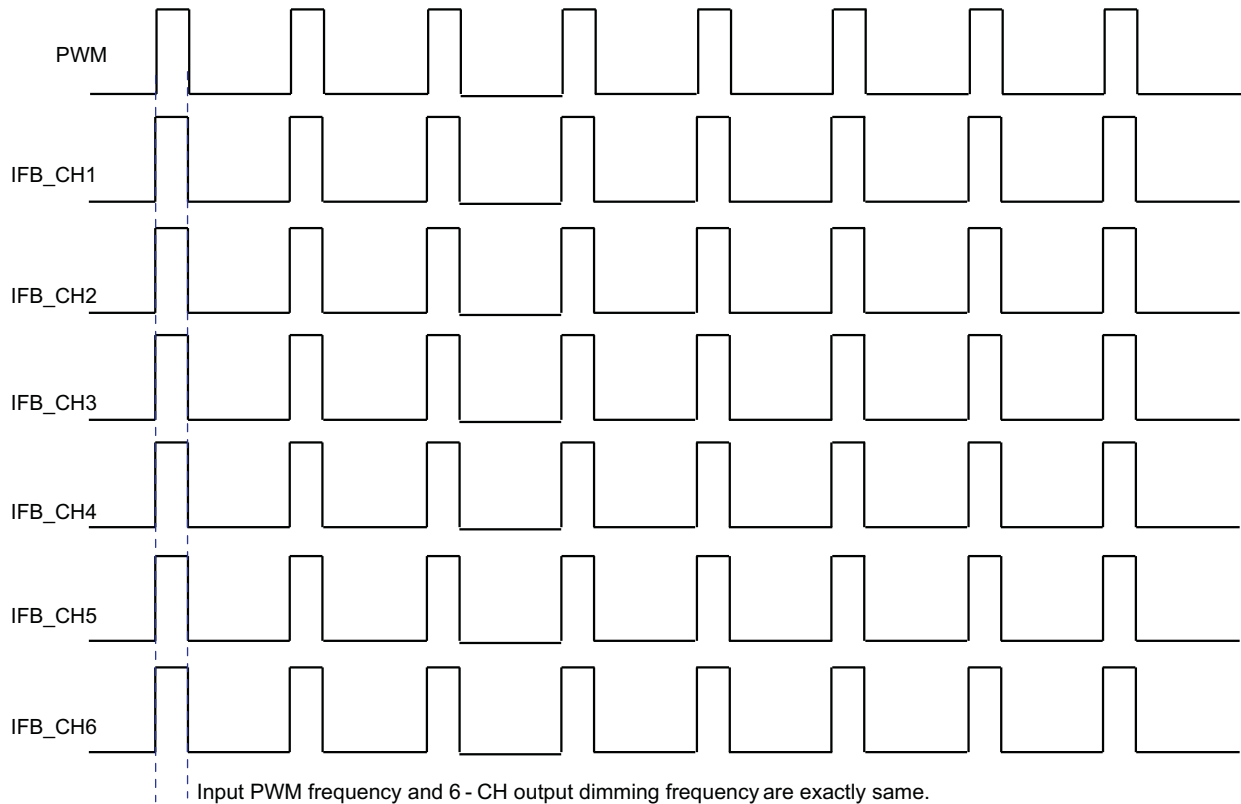

Figure 20. Direct PWM Dimming Timing Diagram

OVER VOLTAGE CLAMP / VOLTAGE FEEDBACK (OVC / FB)

The correct divider ratio is important for optimum operation of the TPS61187. Use the following guidelines to choose the divider value. It can be noise sensitive if R_{upper} and R_{down} have high impedance. Careful layout is required. Also, choose lower resistance values for R_{upper} and R_{down} when power dissipation allows.

Step1. Determine the maximum output voltage, V_O , for the system according to the number of series WLEDs.

Step2. Select an R_{upper} resistor value (1 M Ω for a typical application; a lower value such as 100 k Ω for a noisy environment).

Step3. Calculate R_{down} using [Equation 5](#).

$$V_{OVP} = \left(\frac{R_{upper}}{R_{down}} + 1 \right) \times V_{OV_TH} \quad (5)$$

Where: $V_{OV_TH} = 1.95$ V

When the IC detects that the OVC pin exceeds 1.95 V typical, indicating that the output voltage is over the set threshold point, the OVC circuitry clamps the output voltage to the set threshold.

CURRENT SINK OPEN PROTECTION

For the TPS61187, if one of the WLED strings is open, the IC automatically detects and disables that string. The IC detects the open WLED string by sensing no current in the corresponding IFB pin. As a result, the IC deactivates the open IFB pin and removes it from the voltage feedback loop. Subsequently, the output voltage drops and is regulated to the minimum voltage required for the connected WLED strings. The IFB current of the connected WLED strings remains in regulation.

If any IFB pin voltage exceeds the IFB over-voltage threshold (13.5 V typical), the IC turns off the corresponding current sink and removes this IFB pin from the regulation loop. The current regulation of the remaining IFB pins is not affected. This condition often occurs when there are several shorted WLEDs in one string. WLED mismatch typically does not create large voltage differences among WLED strings.

The IC only shuts down if it detects that all of the WLED strings are open. If an open string is reconnected again, a power-on reset (POR) or EN pin toggling is required to reactivate a previously deactivated string.

OVER CURRENT AND SHORT CIRCUIT PROTECTION

The TPS61187 has a pulse-by-pulse over-current limit of 2.0 A (min). The PWM switch turns off when the inductor current reaches this current threshold. The PWM switch remains off until the beginning of the next switching cycle. This protects the IC and external components during on overload conditions. When there is a sustained over-current condition, the IC turns off and requires a POR or EN pin toggling to restart. Under severe over-load and/or short circuit conditions, the boost output voltage can be pulled below the required regulated voltage to keep all of the white LEDs operating. Under this condition, the current flows directly from input to output through the inductor and schottky diode. To protect the TPS61187, the device shuts down immediately. The IC restarts after input POR or EN pin toggling.

THERMAL PROTECTION

When the junction temperature of the TPS61187 is over 150°C, the thermal protection circuit is triggered and shuts down the device immediately. Only a POR or EN pin toggling clears the protection and restarts the device.

APPLICATION INFORMATION

INDUCTOR SELECTION

Because selection of the inductor affects power supply steady state operation, transient behavior, and loop stability, the inductor is the most important component in switching power regulator design. There are three specifications most important to the performance of the inductor: inductor value, dc resistance, and saturation current. The TPS61187 is designed to work with inductor values between 10 μH and 47 μH . A 10 μH inductor is typically available in a smaller or lower profile package, while a 47 μH inductor may produce higher efficiency due to a slower switching frequency and/or lower inductor ripple. If the boost output current is limited by the over-current protection of the IC, using a 10 μH inductor and the highest switching frequency maximizes controller output current capability.

Internal loop compensation for PWM control is optimized for the external component values, including typical tolerances, recommended in [Table 3](#). Inductor values can have $\pm 20\%$ tolerance with no current bias. When the inductor current approaches saturation level, its inductance can decrease 20% to 35% from the 0 A value depending on how the inductor vendor defines saturation. In a boost regulator, the inductor dc current can be calculated with [Equation 6](#).

$$I_{\text{DC}} = \frac{V_{\text{out}} \times I_{\text{out}}}{V_{\text{in}} \times \eta} \quad (6)$$

Where:

V_{out} = boost output voltage

I_{out} = boost output current

V_{in} = boost input voltage

η = power conversion efficiency, use 90% for TPS61187 applications

The inductor current peak-to-peak ripple can be calculated with [Equation 7](#).

$$I_{\text{PP}} = \frac{1}{L \times \left(\frac{1}{V_{\text{out}} - V_{\text{in}}} + \frac{1}{V_{\text{in}}} \right) \times F_{\text{S}}} \quad (7)$$

Where:

I_{PP} = inductor peak-to-peak ripple

L = inductor value

F_{S} = Switching frequency

V_{out} = boost output voltage

V_{in} = boost input voltage

Therefore, the peak current seen by the inductor is calculated with [Equation 8](#).

$$I_{\text{P}} = I_{\text{DC}} + \frac{I_{\text{PP}}}{2} \quad (8)$$

Select an inductor with a saturation current over the calculated peak current. To calculate the worst case inductor peak current, use the minimum input voltage, maximum output voltage, and maximum load current.

Regulator efficiency is dependent on the resistance of its high current path and switching losses associated with the PWM switch and power diode. Although the TPS61187 IC has optimized the internal switch resistances, the overall efficiency is affected by the inductor dc resistance (DCR). Lower DCR improves efficiency. However, there is a trade off between DCR and inductor footprint; furthermore, shielded inductors typically have higher DCR than unshielded ones. [Table 3](#) lists the recommended inductors.

Table 3. Recommended Inductor for TPS61187

	L(μH)	DCR(mΩ)	Isat(A)	Size (L x W x H mm)
TOKO				
A915AY – 4R7M	4.7	38	1.87	5.2 x 5.2 x 3.0
A915AY – 100M	10	75	1.24	5.2 x 5.2 x 3.0
TDK				
SLF6028T – 4R7N1R6	4.7	38	1.87	5.2 x 5.2 x 3.0
SLF6028T – 4R7N1R6	10	75	1.24	5.2 x 5.2 x 3.0

OUTPUT CAPACITOR SELECTION

The output capacitor is mainly selected to meet the requirement for output ripple and loop stability. This ripple voltage is related to the capacitance of the capacitor and its equivalent series resistance (ESR). Assuming a capacitor with zero ESR, the minimum capacitance needed for a given ripple can be calculated with [Equation 9](#):

$$C_{out} = \frac{(V_{out} - V_{in}) \times I_{out}}{V_{out} \times F_s \times V_{ripple}} \quad (9)$$

Where:

V_{ripple} = peak-to-peak output ripple. The additional part of the ripple caused by ESR is calculated using:

$$V_{ripple_ESR} = I_{out} \times RESR$$

Due to its low ESR, V_{ripple_ESR} can be neglected for ceramic capacitors, but must be considered if tantalum or electrolytic capacitors are used. The controller output voltage also ripples due to the load transient that occurs during PWM dimming. The TPS61187 adopts a patented technology to limit this type of output ripple even with the minimum recommended output capacitance. In a typical application, the output ripple is less than 250 mV during PWM dimming with a 4.7 μF output capacitor. However, the output ripple decreases with higher output capacitances.

ISOLATION FET SELECTION

The TPS61187 provides a gate driver to an external P channel MOSFET which can be turned off during device shutdown or fault condition. This MOSFET can provide a true shutdown function and also protect the battery from output short circuit conditions. The source of the PMOS should be connected to the input, and a pull-up resistor is required between the source and gate of the FET to keep the FET off during IC shutdown. To turn on the isolation FET, the FAULT pin is pulled low and clamped at 8 V below the VBAT pin voltage. During device shutdown or fault condition, the isolation FET is turned off, and the input voltage is applied on the isolation MOSFET. During a short circuit condition, the catch diode (D2 in the typical application circuit) is forward biased when the isolation FET is turned off. The drain of the isolation FET swings below ground. The voltage across the isolation FET can be momentarily greater than the input voltage. Therefore, select a 30 V PMOS for a 24 V maximum input. The on resistance of the FET has a large impact on power conversion efficiency since the FET carries the input voltage. Select a MOSFET with R_{ds(on)} less than 100 mΩ to limit the power losses.

LAYOUT CONSIDERATION

As for all switching power supplies, especially those providing high current and using high switching frequencies, layout is an important design step. If layout is not carefully done, the regulator could show instability as well as EMI problems. Therefore, use wide and short traces for high current paths. The input capacitor, C1 in the Typical Application – Phase Shift PWM Mode figure, needs not only to be close to the VIN pin, but also to the GND pin in order to reduce the input ripple seen by the IC. The input capacitor, C1 in the typical application circuit, should also be placed close to the inductor. C2 is the filter and noise decoupling capacitor for the internal linear regulator powering the internal digital circuits. It should be placed as close as possible between the VDDIO and AGND pins to prevent any noise insertion to the digital circuits. The SW pin carries high current with fast rising and falling edges. Therefore, the connection between the pin to the inductor and schottky diode should be kept as short and wide as possible. It is also beneficial to have the ground of the output capacitor C3 close to the PGND pin since there is a large ground return current flowing between them. When laying out signal grounds, it is recommended to use short traces separated from power ground traces, and connect them together at a single point, for example on the thermal pad. The thermal pad needs to be soldered on to the PCB and connected to the GND pin of the IC. An additional thermal via can significantly improve power dissipation of the IC.

REVISION HISTORY

Changes from Original (June 2010) to Revision A	Page
• Changed Typical Application graphic	1
• Changed ceramic capacitor value, attached to VDDIO, from 0.1 to 1.0 μ F	5
• Changed bypass capacitor value in SUPPLY VOLTAGE section from 0.1 to 1.0 μ F.	10
• Changed BRIGHTNESS DIMMING CONTROL section	11
• Deleted PWM BRIGHTNESS CONTROL INTERFACE section	12
Changes from Revision A (July 2010) to Revision B	Page
• Changed in ABS MAX table, in row "All other pins", MAX col: from 3.6 to 3.7	2
Changes from Revision B (April 2011) to Revision C	Page
• Changed From: TPS61187 To: TPS61187RTJ in the PACKAGE INFORMATION table	2
• Added a description paragraph and replaced Figure 19 in the PHASE SHIFT PWM DIMMING section	12
Changes from Revision C (September 2011) to Revision D	Page
• Changed Figure 2 X axis unit from mA to A	6
• Changed Figure 3 X axis unit from mA to A	6

PACKAGING INFORMATION

Orderable Device	Status ⁽¹⁾	Package Type	Package Drawing	Pins	Package Qty	Eco Plan ⁽²⁾	Lead/ Ball Finish	MSL Peak Temp ⁽³⁾	Samples (Requires Login)
TPS61187RTJR	ACTIVE	QFN	RTJ	20	3000	Green (RoHS & no Sb/Br)	CU NIPDAU	Level-2-260C-1 YEAR	
TPS61187RTJT	ACTIVE	QFN	RTJ	20	250	Green (RoHS & no Sb/Br)	CU NIPDAU	Level-2-260C-1 YEAR	

⁽¹⁾ The marketing status values are defined as follows:

ACTIVE: Product device recommended for new designs.

LIFEBUY: TI has announced that the device will be discontinued, and a lifetime-buy period is in effect.

NRND: Not recommended for new designs. Device is in production to support existing customers, but TI does not recommend using this part in a new design.

PREVIEW: Device has been announced but is not in production. Samples may or may not be available.

OBsolete: TI has discontinued the production of the device.

⁽²⁾ Eco Plan - The planned eco-friendly classification: Pb-Free (RoHS), Pb-Free (RoHS Exempt), or Green (RoHS & no Sb/Br) - please check <http://www.ti.com/productcontent> for the latest availability information and additional product content details.

TBD: The Pb-Free/Green conversion plan has not been defined.

Pb-Free (RoHS): TI's terms "Lead-Free" or "Pb-Free" mean semiconductor products that are compatible with the current RoHS requirements for all 6 substances, including the requirement that lead not exceed 0.1% by weight in homogeneous materials. Where designed to be soldered at high temperatures, TI Pb-Free products are suitable for use in specified lead-free processes.

Pb-Free (RoHS Exempt): This component has a RoHS exemption for either 1) lead-based flip-chip solder bumps used between the die and package, or 2) lead-based die adhesive used between the die and leadframe. The component is otherwise considered Pb-Free (RoHS compatible) as defined above.

Green (RoHS & no Sb/Br): TI defines "Green" to mean Pb-Free (RoHS compatible), and free of Bromine (Br) and Antimony (Sb) based flame retardants (Br or Sb do not exceed 0.1% by weight in homogeneous material)

⁽³⁾ MSL, Peak Temp. -- The Moisture Sensitivity Level rating according to the JEDEC industry standard classifications, and peak solder temperature.

Important Information and Disclaimer: The information provided on this page represents TI's knowledge and belief as of the date that it is provided. TI bases its knowledge and belief on information provided by third parties, and makes no representation or warranty as to the accuracy of such information. Efforts are underway to better integrate information from third parties. TI has taken and continues to take reasonable steps to provide representative and accurate information but may not have conducted destructive testing or chemical analysis on incoming materials and chemicals. TI and TI suppliers consider certain information to be proprietary, and thus CAS numbers and other limited information may not be available for release.

In no event shall TI's liability arising out of such information exceed the total purchase price of the TI part(s) at issue in this document sold by TI to Customer on an annual basis.

TAPE AND REEL INFORMATION

REEL DIMENSIONS



TAPE DIMENSIONS



A0	Dimension designed to accommodate the component width
B0	Dimension designed to accommodate the component length
K0	Dimension designed to accommodate the component thickness
W	Overall width of the carrier tape
P1	Pitch between successive cavity centers

TAPE AND REEL INFORMATION

*All dimensions are nominal

Device	Package Type	Package Drawing	Pins	SPQ	Reel Diameter (mm)	Reel Width W1 (mm)	A0 (mm)	B0 (mm)	K0 (mm)	P1 (mm)	W (mm)	Pin1 Quadrant
TPS61187RTJR	QFN	RTJ	20	3000	330.0	12.4	4.25	4.25	1.15	8.0	12.0	Q2
TPS61187RTJT	QFN	RTJ	20	250	180.0	12.4	4.25	4.25	1.15	8.0	12.0	Q2

TAPE AND REEL BOX DIMENSIONS

*All dimensions are nominal

Device	Package Type	Package Drawing	Pins	SPQ	Length (mm)	Width (mm)	Height (mm)
TPS61187RTJR	QFN	RTJ	20	3000	346.0	346.0	29.0
TPS61187RTJT	QFN	RTJ	20	250	210.0	185.0	35.0

RTJ (S-PWQFN-N20)

PLASTIC QUAD FLATPACK NO-LEAD

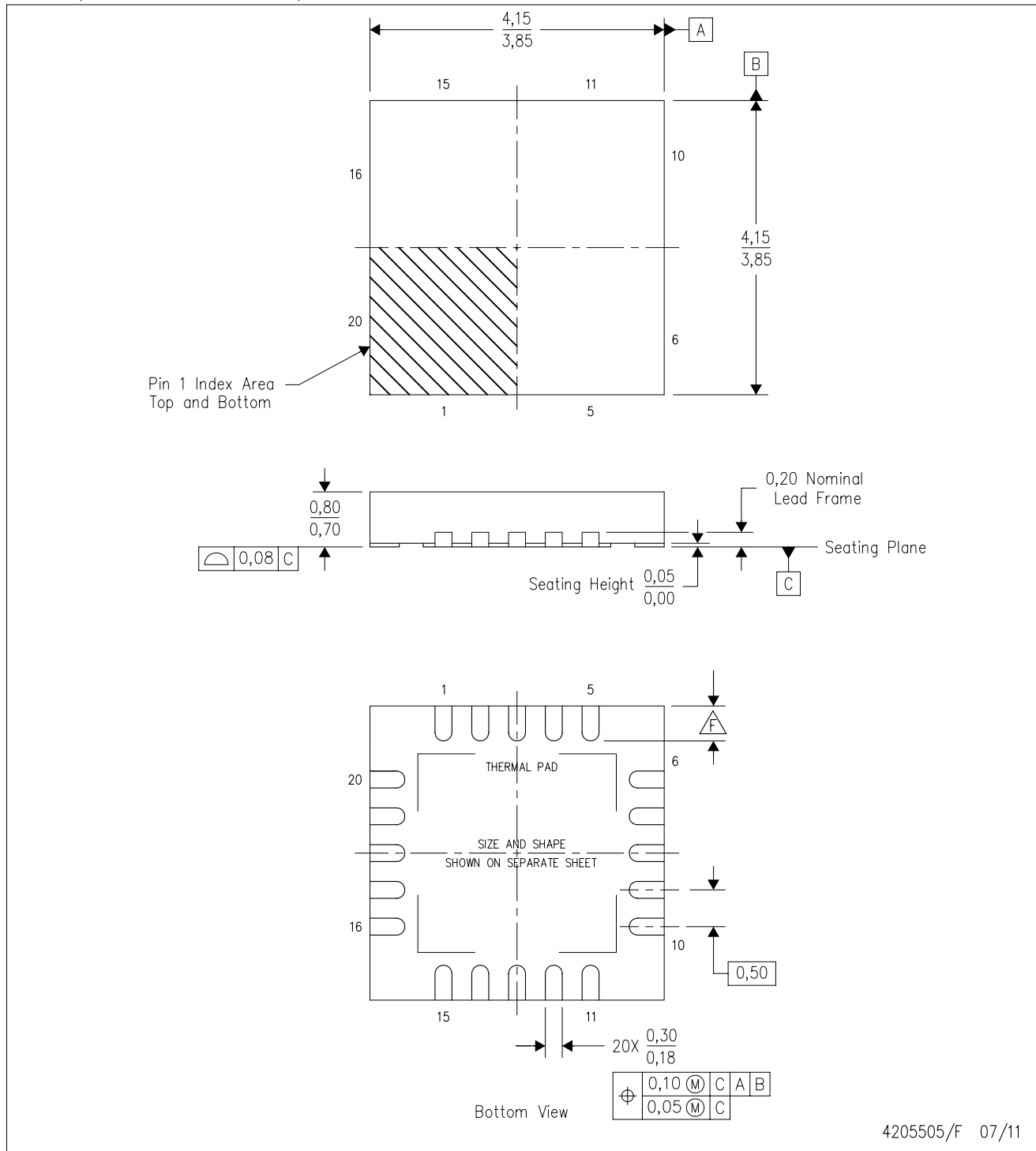

- NOTES:
- All linear dimensions are in millimeters. Dimensioning and tolerancing per ASME Y14.5-1994.
 - This drawing is subject to change without notice.
 - QFN (Quad Flatpack No-Lead) package configuration.
 - The package thermal pad must be soldered to the board for thermal and mechanical performance.
 - See the additional figure in the Product Data Sheet for details regarding the exposed thermal pad features and dimensions.
- ⚠ Check thermal pad mechanical drawing in the product datasheet for nominal lead length dimensions.

RTJ (S-PWQFN-N20)

PLASTIC QUAD FLATPACK NO-LEAD

THERMAL INFORMATION

This package incorporates an exposed thermal pad that is designed to be attached directly to an external heatsink. The thermal pad must be soldered directly to the printed circuit board (PCB). After soldering, the PCB can be used as a heatsink. In addition, through the use of thermal vias, the thermal pad can be attached directly to the appropriate copper plane shown in the electrical schematic for the device, or alternatively, can be attached to a special heatsink structure designed into the PCB. This design optimizes the heat transfer from the integrated circuit (IC).

For information on the Quad Flatpack No-Lead (QFN) package and its advantages, refer to Application Report, QFN/SON PCB Attachment, Texas Instruments Literature No. SLUA271. This document is available at www.ti.com.

The exposed thermal pad dimensions for this package are shown in the following illustration.

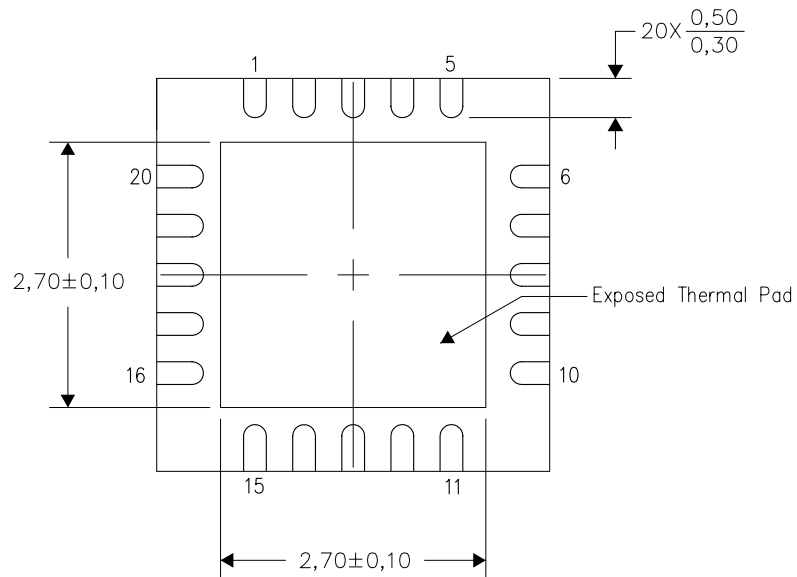

Bottom View

Exposed Thermal Pad Dimensions

4206256-2/Q 07/11

NOTE: All linear dimensions are in millimeters

RTJ (S-PWQFN-N20)

PLASTIC QUAD FLATPACK NO-LEAD

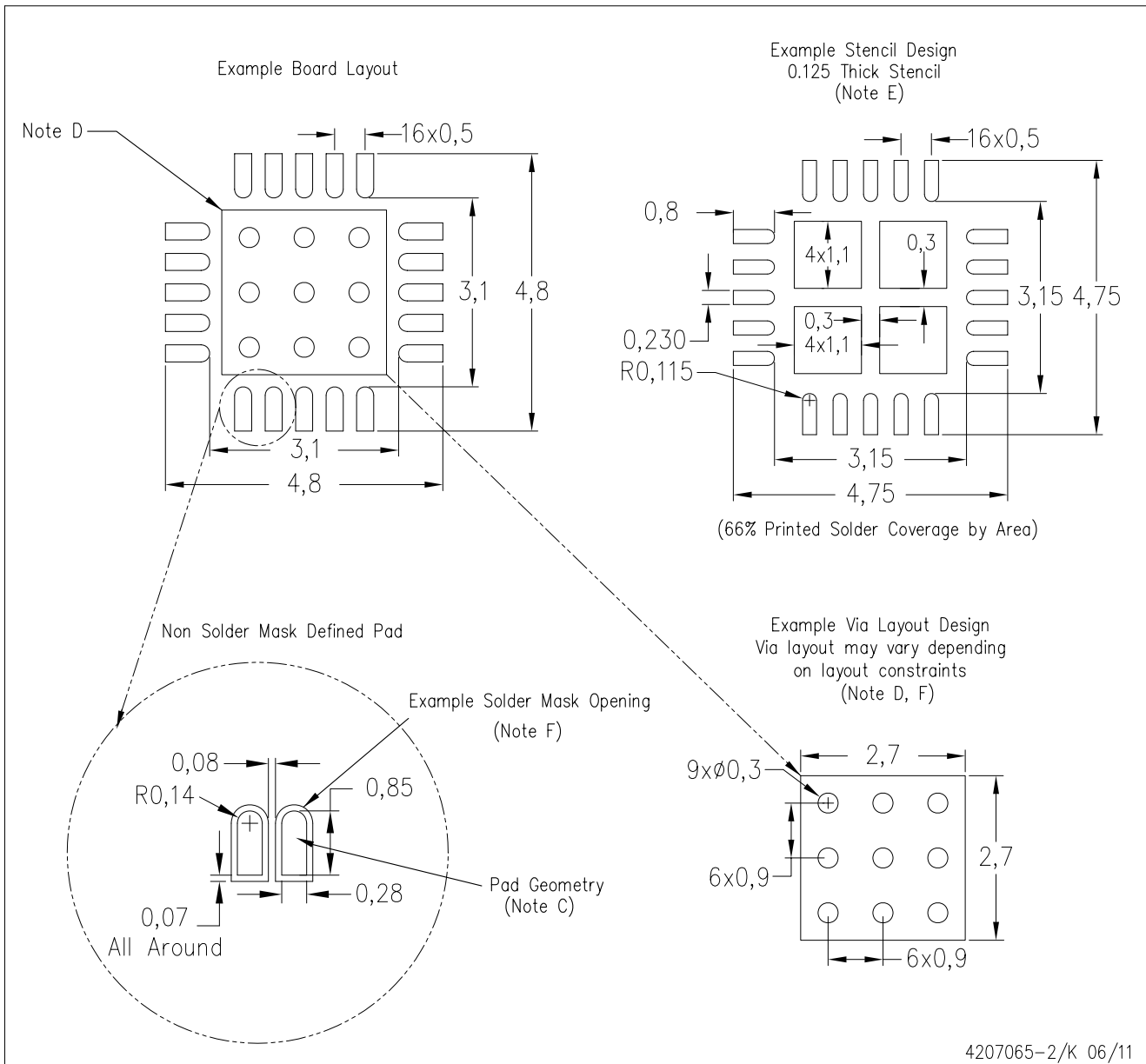

- NOTES:
- A. All linear dimensions are in millimeters.
 - B. This drawing is subject to change without notice.
 - C. Publication IPC-7351 is recommended for alternate designs.
 - D. This package is designed to be soldered to a thermal pad on the board. Refer to Application Note, Quad Flat-Pack Packages, Texas Instruments Literature No. SLUA271, and also the Product Data Sheets for specific thermal information, via requirements, and recommended board layout. These documents are available at www.ti.com <<http://www.ti.com>>.
 - E. Laser cutting apertures with trapezoidal walls and also rounding corners will offer better paste release. Customers should contact their board assembly site for stencil design recommendations. Refer to IPC 7525 for stencil design considerations.
 - F. Customers should contact their board fabrication site for recommended solder mask tolerances and via tenting recommendations for vias placed in the thermal pad.

IMPORTANT NOTICE

Texas Instruments Incorporated and its subsidiaries (TI) reserve the right to make corrections, modifications, enhancements, improvements, and other changes to its products and services at any time and to discontinue any product or service without notice. Customers should obtain the latest relevant information before placing orders and should verify that such information is current and complete. All products are sold subject to TI's terms and conditions of sale supplied at the time of order acknowledgment.

TI warrants performance of its hardware products to the specifications applicable at the time of sale in accordance with TI's standard warranty. Testing and other quality control techniques are used to the extent TI deems necessary to support this warranty. Except where mandated by government requirements, testing of all parameters of each product is not necessarily performed.

TI assumes no liability for applications assistance or customer product design. Customers are responsible for their products and applications using TI components. To minimize the risks associated with customer products and applications, customers should provide adequate design and operating safeguards.

TI does not warrant or represent that any license, either express or implied, is granted under any TI patent right, copyright, mask work right, or other TI intellectual property right relating to any combination, machine, or process in which TI products or services are used. Information published by TI regarding third-party products or services does not constitute a license from TI to use such products or services or a warranty or endorsement thereof. Use of such information may require a license from a third party under the patents or other intellectual property of the third party, or a license from TI under the patents or other intellectual property of TI.

Reproduction of TI information in TI data books or data sheets is permissible only if reproduction is without alteration and is accompanied by all associated warranties, conditions, limitations, and notices. Reproduction of this information with alteration is an unfair and deceptive business practice. TI is not responsible or liable for such altered documentation. Information of third parties may be subject to additional restrictions.

Resale of TI products or services with statements different from or beyond the parameters stated by TI for that product or service voids all express and any implied warranties for the associated TI product or service and is an unfair and deceptive business practice. TI is not responsible or liable for any such statements.

TI products are not authorized for use in safety-critical applications (such as life support) where a failure of the TI product would reasonably be expected to cause severe personal injury or death, unless officers of the parties have executed an agreement specifically governing such use. Buyers represent that they have all necessary expertise in the safety and regulatory ramifications of their applications, and acknowledge and agree that they are solely responsible for all legal, regulatory and safety-related requirements concerning their products and any use of TI products in such safety-critical applications, notwithstanding any applications-related information or support that may be provided by TI. Further, Buyers must fully indemnify TI and its representatives against any damages arising out of the use of TI products in such safety-critical applications.

TI products are neither designed nor intended for use in military/aerospace applications or environments unless the TI products are specifically designated by TI as military-grade or "enhanced plastic." Only products designated by TI as military-grade meet military specifications. Buyers acknowledge and agree that any such use of TI products which TI has not designated as military-grade is solely at the Buyer's risk, and that they are solely responsible for compliance with all legal and regulatory requirements in connection with such use.

TI products are neither designed nor intended for use in automotive applications or environments unless the specific TI products are designated by TI as compliant with ISO/TS 16949 requirements. Buyers acknowledge and agree that, if they use any non-designated products in automotive applications, TI will not be responsible for any failure to meet such requirements.

Following are URLs where you can obtain information on other Texas Instruments products and application solutions:

Products

Audio	www.ti.com/audio
Amplifiers	amplifier.ti.com
Data Converters	dataconverter.ti.com
DLP® Products	www.dlp.com
DSP	dsp.ti.com
Clocks and Timers	www.ti.com/clocks
Interface	interface.ti.com
Logic	logic.ti.com
Power Mgmt	power.ti.com
Microcontrollers	microcontroller.ti.com
RFID	www.ti-rfid.com
OMAP Mobile Processors	www.ti.com/omap
Wireless Connectivity	www.ti.com/wirelessconnectivity

Applications

Automotive and Transportation	www.ti.com/automotive
Communications and Telecom	www.ti.com/communications
Computers and Peripherals	www.ti.com/computers
Consumer Electronics	www.ti.com/consumer-apps
Energy and Lighting	www.ti.com/energy
Industrial	www.ti.com/industrial
Medical	www.ti.com/medical
Security	www.ti.com/security
Space, Avionics and Defense	www.ti.com/space-avionics-defense
Video and Imaging	www.ti.com/video

TI E2E Community Home Page

e2e.ti.com

Mailing Address: Texas Instruments, Post Office Box 655303, Dallas, Texas 75265
Copyright © 2012, Texas Instruments Incorporated