



1V, Low-Power, DirectDrive, Stereo Headphone Amplifier with Shutdown

General Description

The MAX9725 fixed-gain, stereo headphone amplifier is ideal for portable equipment where board space is at a premium. The MAX9725 uses a unique, patented DirectDrive™ architecture to produce a ground-referenced output from a single supply, eliminating the need for large DC-blocking capacitors, saving cost, board space, and component height. Fixed gains of -2V/V (MAX9725A), 1.5V/V (MAX9725B), -1V/V (MAX9725C), and -4V/V (MAX9725D) further reduce external component count.

The MAX9725 delivers up to 20mW per channel into a 32Ω load and achieves 0.006% THD+N. An 80dB at 1kHz power-supply rejection ratio (PSRR) allows the MAX9725 to operate from noisy digital supplies without an additional linear regulator. The MAX9725 includes ±8kV ESD protection on the headphone output. Comprehensive click-and-pop circuitry suppresses audible clicks and pops at startup and shutdown. A low-power shutdown mode reduces supply current to 0.6μA (typ).

The MAX9725 operates from a single 0.9V to 1.8V supply, allowing the device to be powered directly from a single AA or AAA battery. The MAX9725 consumes only 2.1mA of supply current, provides short-circuit protection, and is specified over the extended -40°C to +85°C temperature range. The MAX9725 is available in a tiny (1.54mm x 2.02mm x 0.6mm) 12-bump chip-scale package (UCSP™) and a 12-pin thin QFN package (4mm x 4mm x 0.8mm).

Applications

MP3 Players	Smart Phones
Cellular Phones	Portable Audio Equipment
PDA's	

Ordering Information

PART	TEMP RANGE	PIN-PACKAGE	TOP MARK	GAIN (V/V)
MAX9725AEBC-T*	-40°C to +85°C	12 UCSP-12	ACK	-2
MAX9725AETC	-40°C to +85°C	12 TQFN-EP**	AAEW	-2
MAX9725BEBC-T*	-40°C to +85°C	12 UCSP-12	ACL	-1.5
MAX9725BETC	-40°C to +85°C	12 TQFN-EP**	AAEX	-1.5
MAX9725CEBC-T*	-40°C to +85°C	12 UCSP-12	ACM	-1
MAX9725CETC	-40°C to +85°C	12 TQFN-EP**	AAEY	-1
MAX9725DEBC-T*	-40°C to +85°C	12 UCSP-12	ACN	-4
MAX9725DETC	-40°C to +85°C	12 TQFN-EP**	AAEZ	-4

*Future product—contact factory for availability.

**EP = Exposed paddle.

UCSP is a trademark of Maxim Integrated Products, Inc.

Features

- ◆ Low Quiescent Current (2.1mA)
- ◆ Single-Cell, 0.9V to 1.8V Single-Supply Operation
- ◆ Fixed Gain Eliminates External Feedback Network
 - MAX9725A: -2V/V
 - MAX9725B: -1.5V/V
 - MAX9725C: -1V/V
 - MAX9725D: -4V/V
- ◆ Ground-Referenced Outputs Eliminate DC Bias
- ◆ No Degradation of Low-Frequency Response Due to Output Capacitors
- ◆ 20mW per Channel into 32Ω
- ◆ Low 0.006% THD+N
- ◆ High PSRR (80dB at 1kHz)
- ◆ Integrated Click-and-Pop Suppression
- ◆ Low-Power Shutdown Control
- ◆ Short-Circuit Protection
- ◆ ±8kV ESD-Protected Amplifier Outputs
- ◆ Available in Space-Saving Packages
 - 12-Bump UCSP (1.54mm x 2.02mm x 0.6mm)
 - 12-Pin Thin QFN (4mm x 4mm x 0.8mm)

Block Diagram

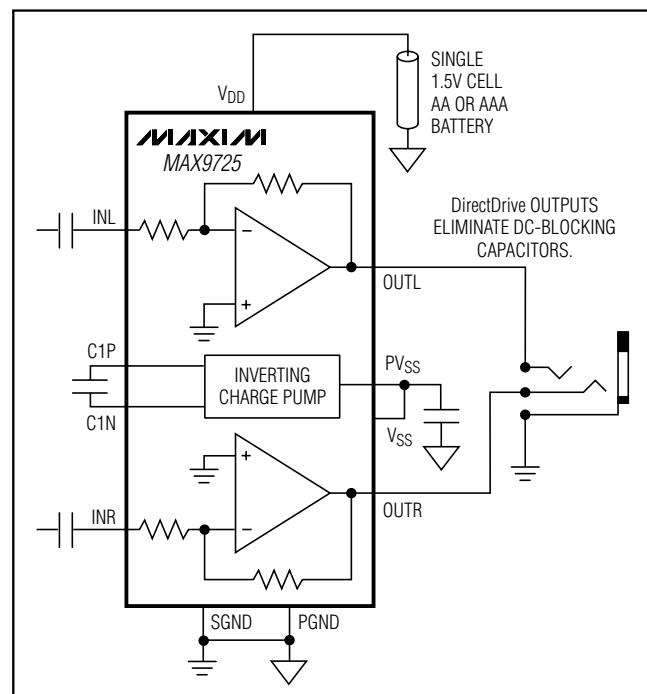

Pin Configurations appear at end of data sheet.



1V, Low-Power, DirectDrive, Stereo Headphone Amplifier with Shutdown

ABSOLUTE MAXIMUM RATINGS

SGND to PGND	-0.3V to +0.3V
V _{DD} to SGND or PGND	-0.3V to +2V
V _{SS} to PV _{SS}	-0.3V to +0.3V
C1P to PGND.....	-0.3V to (V _{DD} + 0.3V)
C1N to PGND.....	(PV _{SS} - 0.3V) to +0.3V
V _{SS} , PV _{SS} to GND	+0.3V to -2V
OUTR, OUTL, INR, INL to SGND	(V _{SS} - 0.3V) to (V _{DD} + 0.3V)
SHDN to SGND or PGND	-0.3V to +4V
Output Short-Circuit Current	Continuous

Continuous Power Dissipation (T _A = +70°C)	
12-Bump UCSP (derate 6.5mW/°C above +70°C)....	518.8mW
12-Pin Thin QFN (derate 16.9mW/°C above +70°C) ..	1349.1mW
Junction Temperature	+150°C
Operating Temperature Range	-40°C to +85°C
Storage Temperature Range	-65°C to +150°C
Bump Temperature (soldering) Reflow	+230°C
Lead Temperature (soldering, 10s)	+300°C

Stresses beyond those listed under "Absolute Maximum Ratings" may cause permanent damage to the device. These are stress ratings only, and functional operation of the device at these or any other conditions beyond those indicated in the operational sections of the specifications is not implied. Exposure to absolute maximum rating conditions for extended periods may affect device reliability.

ELECTRICAL CHARACTERISTICS

(V_{DD} = 1.5V, PGND = SGND = 0V, V_{SHDN} = 1.5V, V_{SS} = PV_{SS}, C1 = C2 = 1μF, C_{IN} = 1μF, R_L = ∞, T_A = T_{MIN} to T_{MAX}, unless otherwise noted. Typical values are at T_A = +25°C.) (See the Functional Diagram.)

PARAMETER	SYMBOL	CONDITIONS	MIN	TYP	MAX	UNITS	
Supply Voltage Range	V _{DD}	Guaranteed by PSRR test	0.9		1.8	V	
Quiescent Supply Current	I _{DD}	Both channels active		2.1	3.3	mA	
Shutdown Current	I _{SHDN}	V _{SHDN} = 0V	T _A = +25°C	0.6	10	μA	
			T _A = -40°C to +85°C		30		
Shutdown to Full Operation	t _{ON}			180		μs	
SHDN Thresholds	V _{IH}	V _{DD} = 0.9V to 1.8V	0.7 x V _{DD}			V	
	V _{IL}	V _{DD} = 0.9V to 1.8V	0.3 x V _{DD}				
SHDN Input Leakage Current	I _{LEAK}	V _{DD} = 0.9V to 1.8V (Note 1)			±1	μA	
CHARGE PUMP							
Oscillator Frequency	f _{OSC}		493	580	667	kHz	
AMPLIFIERS							
Voltage Gain	A _v	MAX9725A	-2.04	-2.00	-1.96	V/V	
		MAX9725B	-1.53	-1.5	-1.47		
		MAX9725C	-1.02	-1.00	-0.98		
		MAX9725D	-4.08	-4.00	-3.92		
Gain Match	ΔA _v		±0.5			%	
Total Output Offset Voltage	V _{OS}	Input AC-coupled, R _L = 32Ω to GND, T _A = +25°C	MAX9725A/MAX9725D	±0.3	±1.05	mV	
			MAX9725B	±0.45	±1.58		
			MAX9725C	±0.6	±2.1		
Input Resistance	R _{IN}		15	25	35	kΩ	
Power-Supply Rejection Ratio	PSRR	V _{DD} = 0.9V to 1.8V, T _A = +25°C		60	80	dB	
			100mV _{P-P} ripple	f _{IN} = 1kHz	70		
				f _{IN} = 20kHz	62		
Output Power (Note 2)	P _{OUT}	V _{DD} = 1.5V	R _L = 32Ω	10	20	mW	
			R _L = 16Ω	25			
		V _{DD} = 1.0V, R _L = 32Ω	7				
Total Harmonic Distortion Plus Noise	THD+N	R _L = 32Ω, P _{OUT} = 12mW, f = 1kHz	0.006		%		
		R _L = 16Ω, P _{OUT} = 15mW, f = 1kHz	0.015				
Signal-to-Noise Ratio	SNR	R _L = 32Ω, P _{OUT} = 12mW	BW = 22Hz to 22kHz	89		dB	
			A-weighted filter	92			

1V, Low-Power, DirectDrive, Stereo Headphone Amplifier with Shutdown

ELECTRICAL CHARACTERISTICS (continued)

($V_{DD} = 1.5V$, $PGND = SGND = 0V$, $V_{SHDN} = 1.5V$, $V_{SS} = PV_{SS}$, $C1 = C2 = 1\mu F$, $C_{IN} = 1\mu F$, $R_L = \infty$, $T_A = T_{MIN}$ to T_{MAX} , unless otherwise noted. Typical values are at $T_A = +25^\circ C$.) (See the *Functional Diagram*.)

PARAMETER	SYMBOL	CONDITIONS	MIN	TYP	MAX	UNITS
Slew Rate	SR			0.2		V/ μs
Maximum Capacitive Load	C_L	No sustained oscillations		150		pF
Crosstalk	XTALK	$f_{IN} = 1.0kHz$, $R_L = 32\Omega$, $P_{OUT} = 5mW$		100		dB
Click/Pop Level	K_{CP}	$R_L = 32\Omega$, peak voltage, A-weighted, 32 samples per second (Note 3)	Into shutdown	72.8		dB
			Out of shutdown	72.8		
ESD Protection	V_{ESD}	Human Body Model (OUTR, OUTL)		± 8		kV

Note 1: Input leakage current measurements limited by automated test equipment.

Note 2: $f_{IN} = 1kHz$, $T_A = +25^\circ C$, $THD+N < 1\%$, both channels driven in-phase.

Note 3: Testing performed with 32Ω resistive load connected to outputs. Mode transitions controlled by \overline{SHDN} . K_{CP} level calculated as $20 \log$ [peak voltage under normal operation at rated power level / peak voltage during mode transition]. Inputs are AC-grounded.

Typical Operating Characteristics

($V_{DD} = 1.5V$, $PGND = SGND = 0V$, $V_{SHDN} = 1.5V$, $V_{SS} = PV_{SS}$, $C1 = C2 = 1\mu F$, $C_{IN} = 1\mu F$, $THD+N$ measurement bandwidth = 22Hz to 22kHz, $T_A = +25^\circ C$, unless otherwise noted.) (See the *Functional Diagram*.)

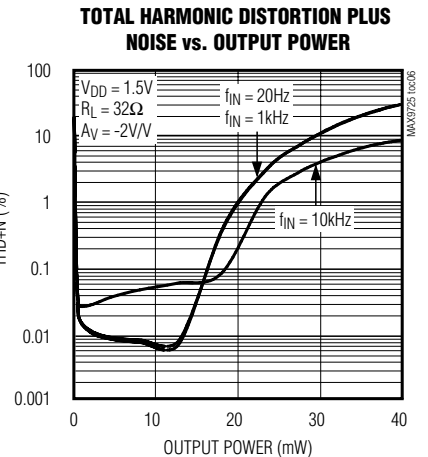
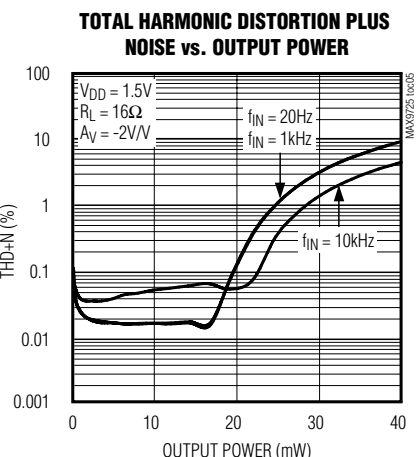
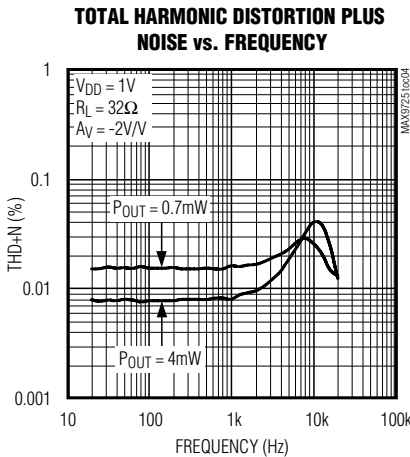
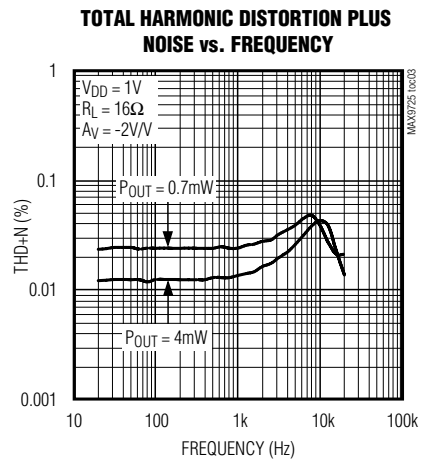
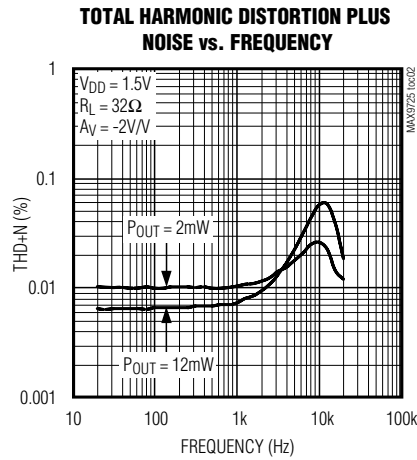
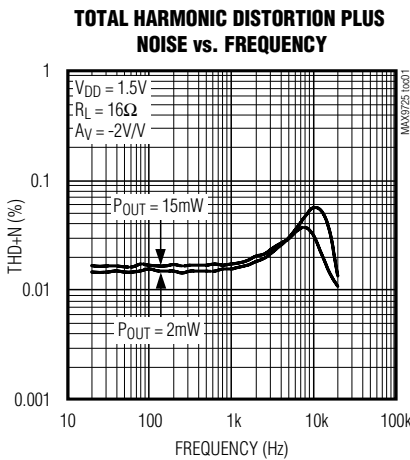

1V, Low-Power, DirectDrive, Stereo Headphone Amplifier with Shutdown

Typical Operating Characteristics (continued)

($V_{DD} = 1.5V$, $PGND = SGND = 0V$, $V_{SHDN} = 1.5V$, $V_{SS} = PV_{SS}$, $C_1 = C_2 = 1\mu F$, $C_{IN} = 1\mu F$, THD+N measurement bandwidth = 22Hz to 22kHz, $T_A = +25^\circ C$, unless otherwise noted.) (See the *Functional Diagram*.)

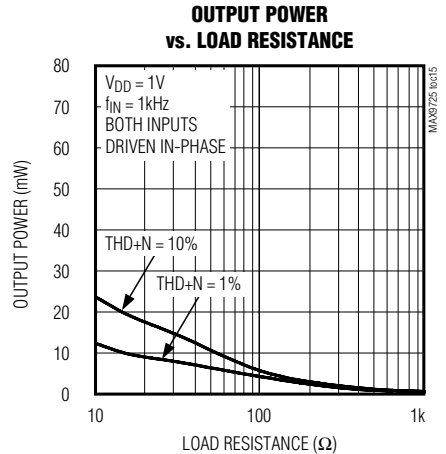
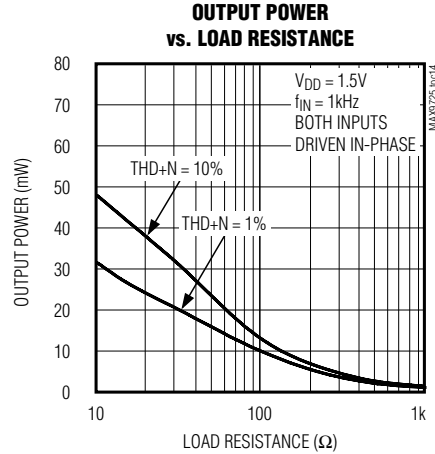
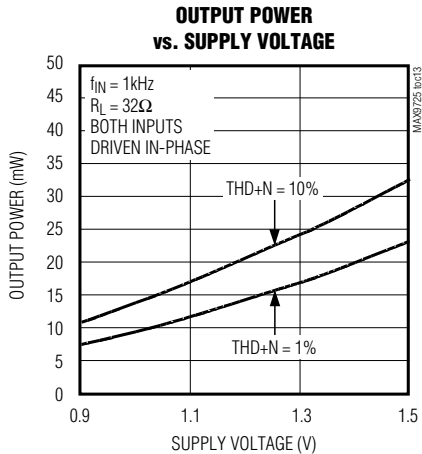
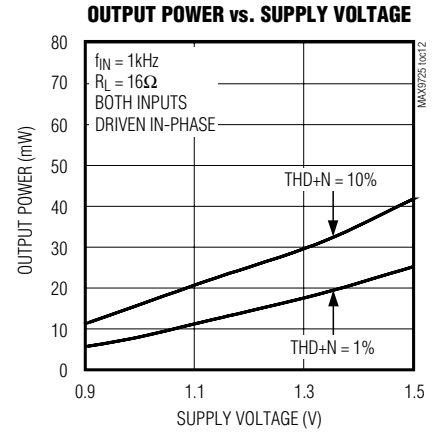
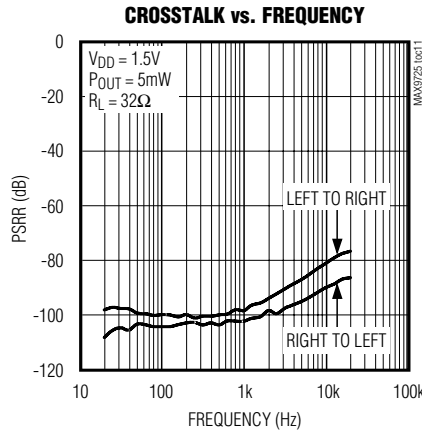
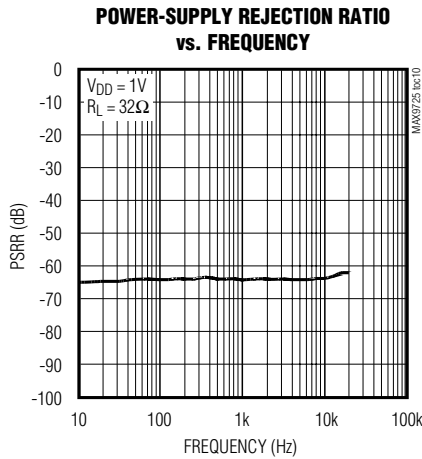
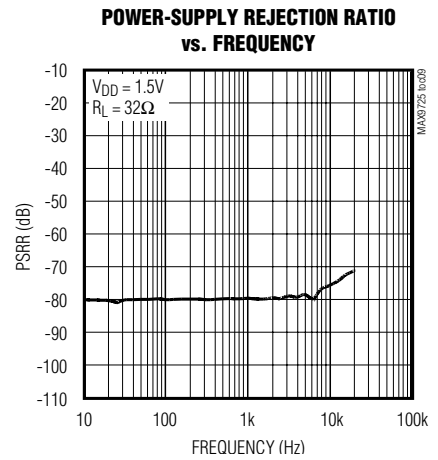
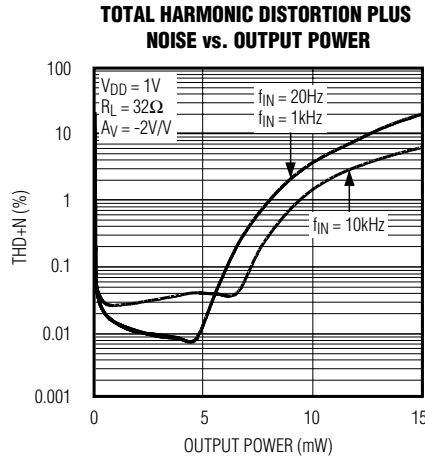
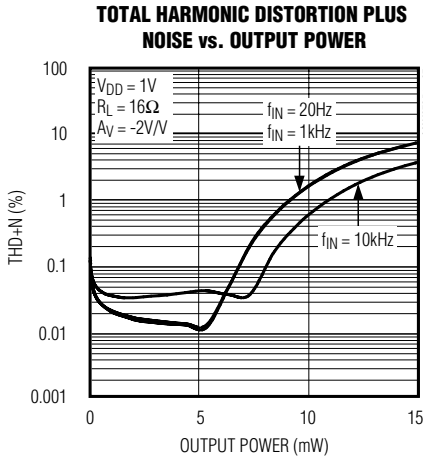

1V, Low-Power, DirectDrive, Stereo Headphone Amplifier with Shutdown

MAX9725

Typical Operating Characteristics (continued)

($V_{DD} = 1.5V$, $PGND = SGND = 0V$, $V_{SHDN} = 1.5V$, $V_{SS} = PV_{SS}$, $C_1 = C_2 = 1\mu F$, $C_{IN} = 1\mu F$, THD+N measurement bandwidth = 22Hz to 22kHz, $T_A = +25^\circ C$, unless otherwise noted.) (See the *Functional Diagram*.)

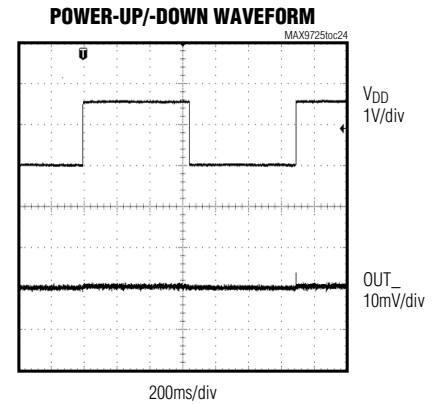
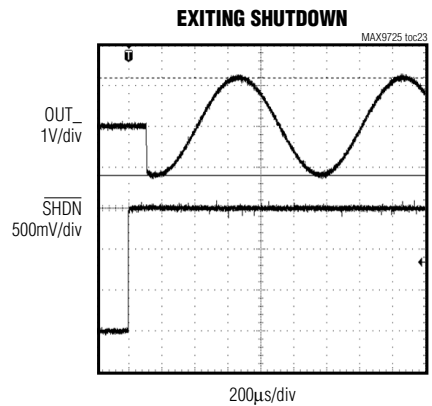
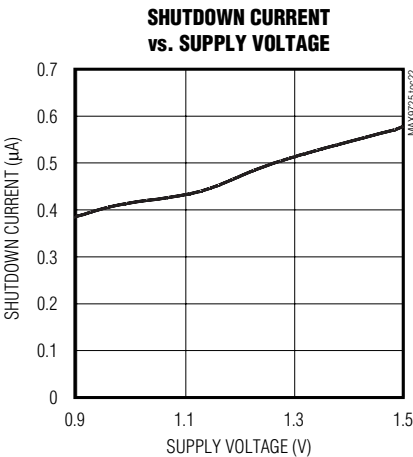
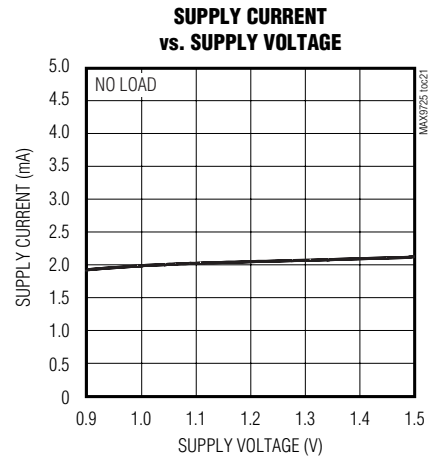
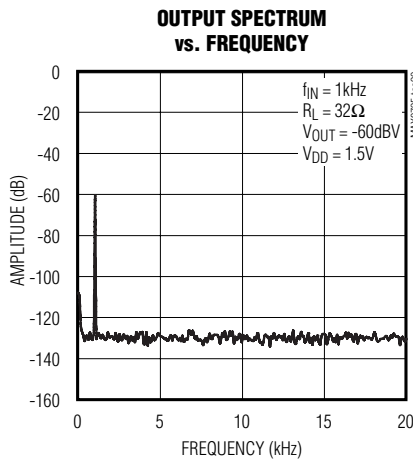
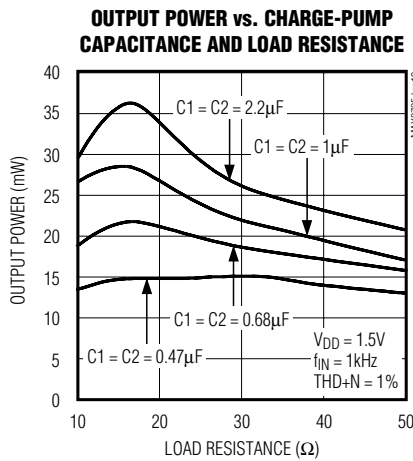
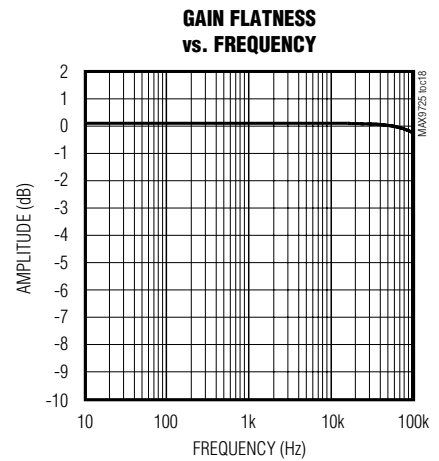
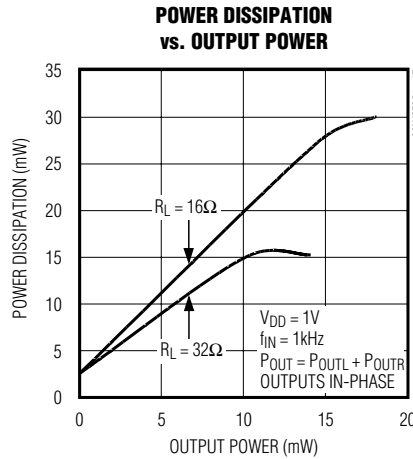
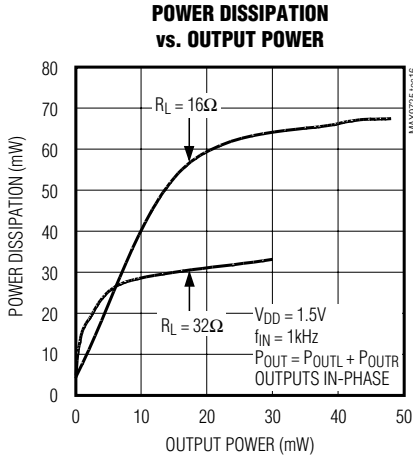

1V, Low-Power, DirectDrive, Stereo Headphone Amplifier with Shutdown

Pin Description

PIN	BUMP	NAME	FUNCTION
THIN QFN	UCSP		
1	A1	C1N	Flying Capacitor Negative Terminal. Connect a 1 μ F capacitor from C1P to C1N.
2	A2	PVSS	Inverting Charge-Pump Output. Bypass with 1 μ F from PVSS to PGND. PVSS must be connected to VSS.
3	A3	INL	Left-Channel Audio Input
4	A4	INR	Right-Channel Audio Input
5	B4	VSS	Amplifier Negative Power Supply. Must be connected to PVSS.
6	B3	SGND	Signal Ground. SGND must be connected to PGND. SGND is the ground reference for the input and output signal.
7	C4	OUTR	Right-Channel Output
8	C3	OUTL	Left-Channel Output
9	C2	VDD	Positive Power-Supply Input. Bypass with a 1 μ F capacitor to PGND.
10	C1	C1P	Flying Capacitor Positive Terminal. Connect a 1 μ F capacitor from C1P to C1N.
11	B1	PGND	Power Ground. Ground reference for the internal charge pump. PGND must be connected to SGND.
12	B2	$\overline{\text{SHDN}}$	Active-Low Shutdown. Connect to VDD for normal operation. Pull low to disable the amplifier and charge pump.
EP	—	EP	Exposed Paddle. Internally connected to VSS. Leave paddle unconnected or solder to VSS.

Detailed Description

The MAX9725 stereo headphone driver features Maxim's patented DirectDrive architecture, eliminating the large output-coupling capacitors required by conventional single-supply headphone drivers. The MAX9725 consists of two 20mW class AB headphone drivers, shutdown control, inverting charge pump, internal gain-setting resistors, and comprehensive click-and-pop suppression circuitry (see the *Functional Diagram*). A negative power supply (PVSS) is created by inverting the positive supply (VDD). Powering the drivers from VDD and PVSS increases the dynamic range of the drivers to almost twice that of other 1V single-supply drivers. This increase in dynamic range allows for higher output power.

The outputs of the MAX9725 are biased about GND (Figure 1). The benefit of this GND bias is that the driver outputs do not have a DC component, thus large DC-blocking capacitors are unnecessary. Eliminating the DC-blocking capacitors on the output saves board space, system cost, and improves frequency response.

DirectDrive

Conventional single-supply headphone drivers have their outputs biased about a nominal DC voltage (typically half the supply) for maximum dynamic range. Large coupling capacitors are needed to block the DC bias from the headphones. Without these capacitors, a significant amount of DC current flows to the headphone, resulting in unnecessary power dissipation and possible damage to both headphone and headphone driver.

Maxim's DirectDrive architecture uses a charge pump to create an internal negative supply voltage. This allows the MAX9725 outputs to be biased about GND, increasing the dynamic range while operating from a single supply. A conventional amplifier powered from 1.5V ideally provides 18mW to a 16 Ω load. The MAX9725 provides 25mW to a 16 Ω load. The DirectDrive architecture eliminates the need for two large (220 μ F, typ) DC-blocking capacitors on the output. The MAX9725 charge pump requires two small ceramic capacitors, conserving board space, reducing cost, and improving the frequency response of the headphone driver. See the Output Power vs. Charge-

1V, Low-Power, DirectDrive, Stereo Headphone Amplifier with Shutdown

MAX9725

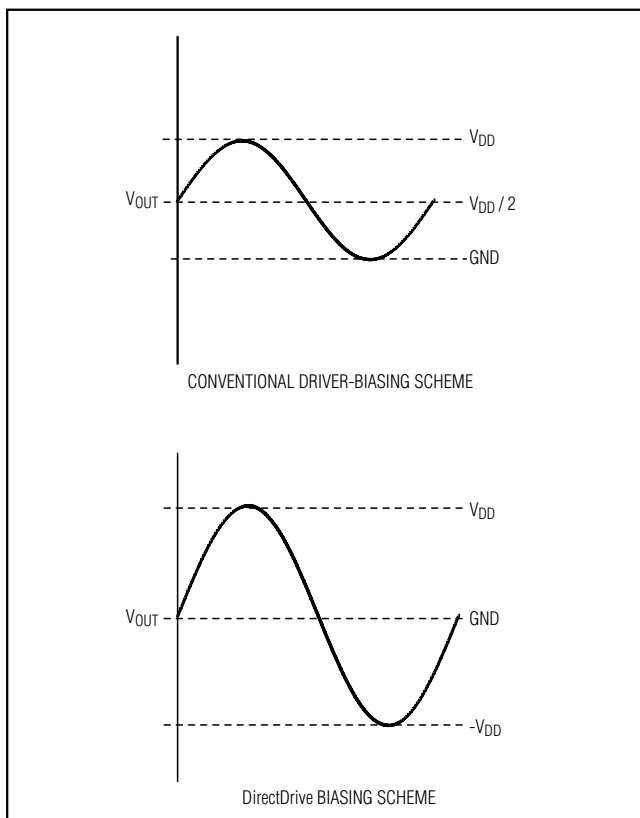

Figure 1. Traditional Driver Output Waveform vs. MAX9725 Output Waveform (Ideal Case)

Pump Capacitance and Load Resistance graph in the *Typical Operating Characteristics* for details of the possible capacitor sizes.

Previous attempts to eliminate the output-coupling capacitors involved biasing the headphone return (sleeve) to the DC-bias voltage of the headphone amplifiers. This method raises some issues:

- The sleeve is typically grounded to the chassis. Using this biasing approach, the sleeve must be isolated from system ground, complicating product design.
- During an ESD strike, the driver's ESD structures are the only path to system ground. The driver must be able to withstand the full ESD strike.
- When using the headphone jack as a line out to other equipment, the bias voltage on the sleeve may conflict with the ground potential from other equipment, resulting in possible damage to the drivers.

Low-Frequency Response

Large DC-blocking capacitors limit the amplifier's low-frequency response and can distort the audio signal:

- 1) The impedance of the headphone load and the DC-blocking capacitor forms a highpass filter with the -3dB point set by:

$$f_{-3dB} = \frac{1}{2\pi R_L C_{OUT}}$$

where R_L is the impedance of the headphone and C_{OUT} is the value of the DC-blocking capacitor. The highpass filter is required by conventional single-ended, single power-supply headphone drivers to block the midrail DC-bias component of the audio signal from the headphones. The drawback to the filter is that it can attenuate low-frequency signals. Larger values of C_{OUT} reduce this effect but result in physically larger, more expensive capacitors. Figure 2 shows the relationship between the size of C_{OUT} and the resulting low-frequency attenuation. Note that the -3dB point for a 16Ω headphone with a 100μF blocking capacitor is 100Hz, well within the normal audio band, resulting in low-frequency attenuation of the reproduced signal.

- 2) The voltage coefficient of the DC-blocking capacitor contributes distortion to the reproduced audio signal as the capacitance value varies when the function of the voltage across the capacitor changes. At low frequencies, the reactance of the capacitor dominates at frequencies below the -3dB point and the voltage coefficient appears as frequency-dependent distortion. Figure 3 shows the THD+N introduced by two different capacitor dielectric types. Note that below 100Hz, THD+N increases rapidly.

The combination of low-frequency attenuation and frequency-dependent distortion compromises audio reproduction in portable audio equipment that emphasizes low-frequency effects such as multimedia laptops, as well as MP3, CD, and DVD players. These low-frequency, capacitor-related deficiencies are eliminated by using DirectDrive technology.

Charge Pump

The MAX9725 features a low-noise charge pump. The 580kHz switching frequency is well beyond the audio range, and does not interfere with the audio signals. The switch drivers feature a controlled switching speed that minimizes noise generated by turn-on and turn-off transients. The di/dt noise caused by the parasitic bond wire and trace inductance is minimized by limiting the turn-on/off speed of the charge pump. Additional high-

1V, Low-Power, DirectDrive, Stereo Headphone Amplifier with Shutdown

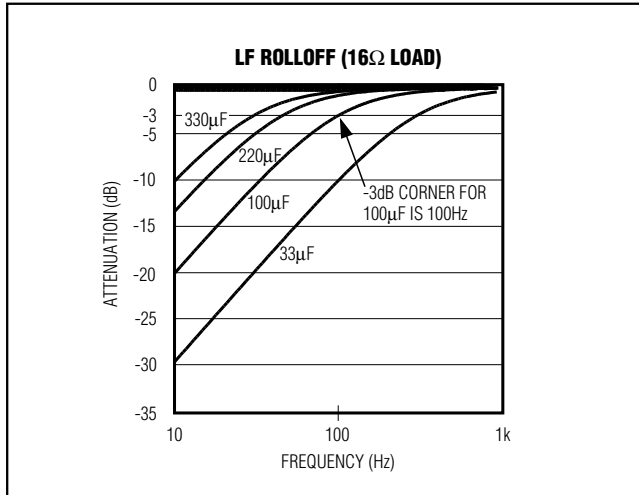

Figure 2. Low-Frequency Attenuation for Common DC-Blocking Capacitor Values

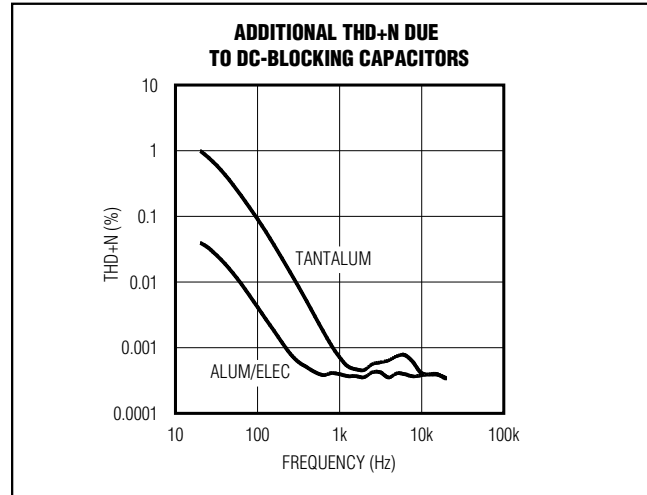

Figure 3. Distortion Contributed By DC-Blocking Capacitors

frequency noise attenuation can be achieved by increasing the size of C2 (see the *Functional Diagram*). Extra noise attenuation is not typically required.

Shutdown

The MAX9725's low-power shutdown mode reduces supply current to 0.6μA. Driving $\overline{\text{SHDN}}$ low disables the amplifiers and charge pump. The driver's output impedance is typically 50kΩ (MAX9725A), 37.5kΩ (MAX9725B), 25kΩ (MAX9725), or 100kΩ (MAX9725D) when in shutdown mode.

Click-and-Pop Suppression

In conventional single-supply audio drivers, the output-coupling capacitor is a major contributor of audible clicks and pops. Upon startup, the driver charges the coupling capacitor to its bias voltage, typically half the supply. Likewise, on shutdown, the capacitor is discharged to GND. This results in a DC shift across the capacitor that appears as an audible transient at the speaker. The MAX9725's DirectDrive technology eliminates the need for output-coupling capacitors.

The MAX9725 also features extensive click-and-pop suppression that eliminates any audible transient sources internal to the device. The Power-Up/Down Waveform in the *Typical Operating Characteristics* shows minimal DC shift and no spurious transients at the output upon startup or shutdown.

In most applications, the output of the preamplifier driving the MAX9725 has a DC bias of typically half the supply. At startup, the input-coupling capacitor is charged to the preamplifier's DC bias voltage through

the internal input resistor (25kΩ, typ) causing an audible click and pop. Delaying the rise of $\overline{\text{SHDN}}$ 4 or 5 time constants, based on $R_{\text{IN}} \times C_{\text{IN}}$, relative to the start-up of the preamplifier eliminates any click and pop caused by the input filter (see the *Functional Diagram*).

Applications Information

Power Dissipation

Linear power amplifiers can dissipate a significant amount of power under normal operating conditions. The maximum power dissipation for each package is given in the *Absolute Maximum Ratings* section under Continuous Power Dissipation or can be calculated by the following equation:

$$P_{\text{DISSPKG(MAX)}} = \frac{T_{\text{J(MAX)}} - T_{\text{A}}}{\theta_{\text{JA}}}$$

where $T_{\text{J(MAX)}}$ is +150°C, T_{A} is the ambient temperature, and θ_{JA} is the reciprocal of the derating factor in °C/W as specified in the *Absolute Maximum Ratings* section. For example, θ_{JA} for the thin QFN package is +59.3°C/W.

The MAX9725 has two power dissipation sources, the charge pump and the two amplifiers. If the power dissipation exceeds the rated package dissipation, reduce V_{DD} , increase load impedance, decrease the ambient temperature, or add heatsinking to the device. Large output, supply, and ground traces decrease θ_{JA} , allowing more heat to be transferred from the package to surrounding air.

1V, Low-Power, DirectDrive, Stereo Headphone Amplifier with Shutdown

MAX9725

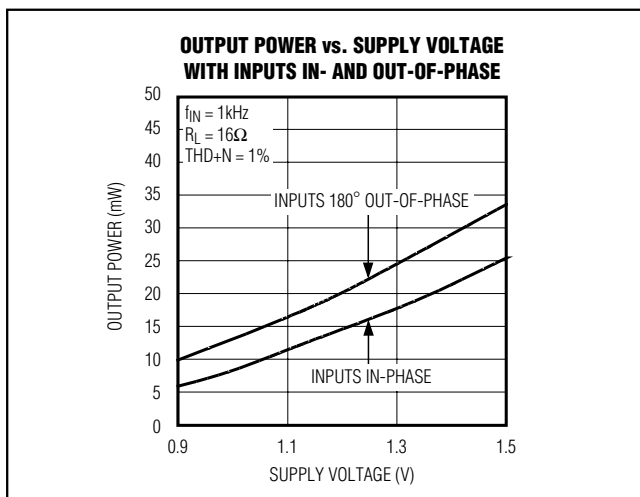

Figure 4. Output Power vs. Supply Voltage with Inputs In-/Out-of-Phase

Output Power

The MAX9725's output power increases when the left and right audio signals differ in magnitude and/or phase. Figure 4 shows the two extreme cases for in- and out-of-phase input signals. The output power of a typical stereo application lies between the two extremes shown in Figure 4. The MAX9725 is specified to output 20mW per channel when both inputs are in-phase.

Powering Other Circuits from the Negative Supply

The MAX9725 internally generates a negative supply voltage (PVSS) to provide the ground-referenced output signal. Other devices can be powered from PVSS provided the current drawn from the charge pump does not exceed 1mA. Headphone driver output power and THD+N will be adversely affected if more than 1mA is drawn from PVSS. Using PVSS as an LCD bias is a typical application for the negative supply.

PVSS is unregulated and proportional to VDD. Connect a 1μF capacitor from C1P to C1N for best charge-pump operation.

Component Selection

Input Filtering

The AC-coupling capacitor (C_{IN}) and an internal gain-setting resistor form a highpass filter that removes any DC bias from an input signal (see the *Functional Diagram*). C_{IN} allows the MAX9725 to bias the signal to an optimum DC level. The -3dB point of the highpass filter, assuming zero source impedance, is given by:

$$f_{-3dB} = \frac{1}{2\pi \times 25k\Omega \times C_{IN}}$$

Choose C_{IN} so f_{-3dB} is well below the lowest frequency of interest. Setting f_{-3dB} too high affects the amplifier's low-frequency response. Use capacitors with low-voltage coefficient dielectrics. Film or COG dielectric capacitors are good choices for AC-coupling capacitors. Capacitors with high-voltage coefficients, such as ceramics, can result in increased distortion at low frequencies.

Charge-Pump Capacitor Selection

Use capacitors with less than 100mΩ of ESR. Low-ESR ceramic capacitors minimize the output impedance of the charge pump. Capacitors with an X7R dielectric provide the best performance over the extended temperature range. Table 1 lists suggested capacitor manufacturers.

Flying Capacitor (C1)

The value of C1 affects the charge pump's load regulation and output impedance. Choosing C1 too small degrades the MAX9725's ability to provide sufficient current drive and leads to a loss of output voltage. Increasing the value of C1 improves load regulation and reduces the charge-pump output impedance. See the Output Power vs. Charge-Pump Capacitance and Load Impedance graph in the *Typical Operating Characteristics*.

Hold Capacitor (C2)

The hold capacitor's value and ESR directly affect the ripple at PVSS. Increasing the value of C2 reduces ripple. Choosing a capacitor with lower ESR reduces ripple and output impedance. Lower capacitance values can be used in systems with low maximum output power levels. See the Output Power vs. Charge-Pump Capacitance and Load Impedance graph in the *Typical Operating Characteristics*.

1V, Low-Power, DirectDrive, Stereo Headphone Amplifier with Shutdown

Table 1. Suggested Capacitor Manufacturers

SUPPLIER	PHONE	FAX	WEBSITE
Taiyo Yuden	800-348-2496	847-925-0899	www.t-yuden.com
TDK	847-803-6100	847-390-4405	www.component.tdk.com

Power-Supply Bypass Capacitor (C3)

The power-supply bypass capacitor (C3) lowers the output impedance of the power supply and reduces the impact of the MAX9725's charge-pump switching transients. Bypass V_{DD} to PGND with the same value as C1. Place C3 as close to V_{DD} as possible.

Layout and Grounding

Proper layout and grounding are essential for optimum performance. Connect PGND and SGND together at a single point on the PC board. Connect PV_{SS} to SV_{SS} and bypass with C2 to PGND. Bypass V_{DD} to PGND with C3. Place capacitors C2 and C3 as close to the MAX9725 as possible. Route PGND, and all traces that carry switching transients, away from SGND and the audio signal path.

The MAX9725 does not require additional heatsinking. The thin QFN package features an exposed paddle that improves thermal efficiency of the package. **Ensure the exposed paddle is electrically isolated from GND and V_{DD} . Connect the exposed paddle to V_{SS} if necessary.**

UCSP Applications Information

For the latest application details on UCSP construction, dimensions, tape carrier information, printed circuit board techniques, bump-pad layout, and recommended reflow temperature profile, as well as the latest information on reliability testing results, go to Maxim's website at www.maxim-ic.com/ucsp for the Application Note: *UCSP—A Wafer-Level Chip-Scale Package*.

Chip Information

TRANSISTOR COUNT: 2559

PROCESS: BiCMOS

1V, Low-Power, DirectDrive, Stereo Headphone Amplifier with Shutdown

MAX9725

System Diagram

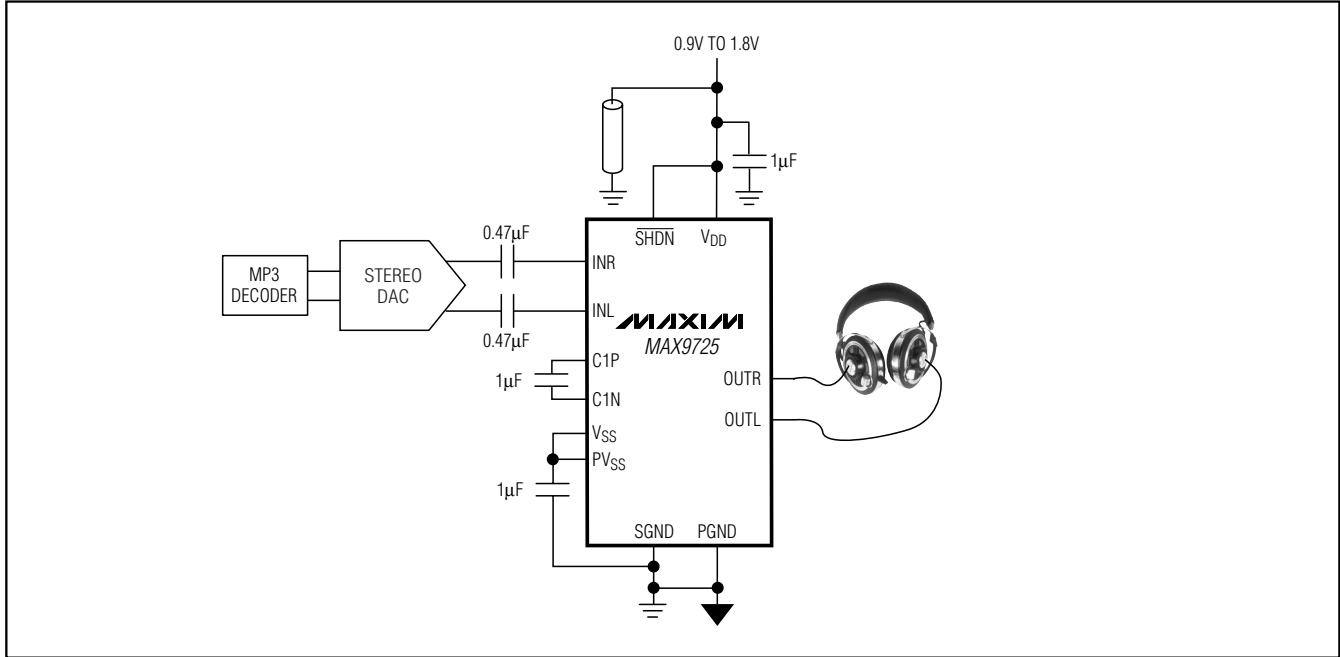

Pin Configurations

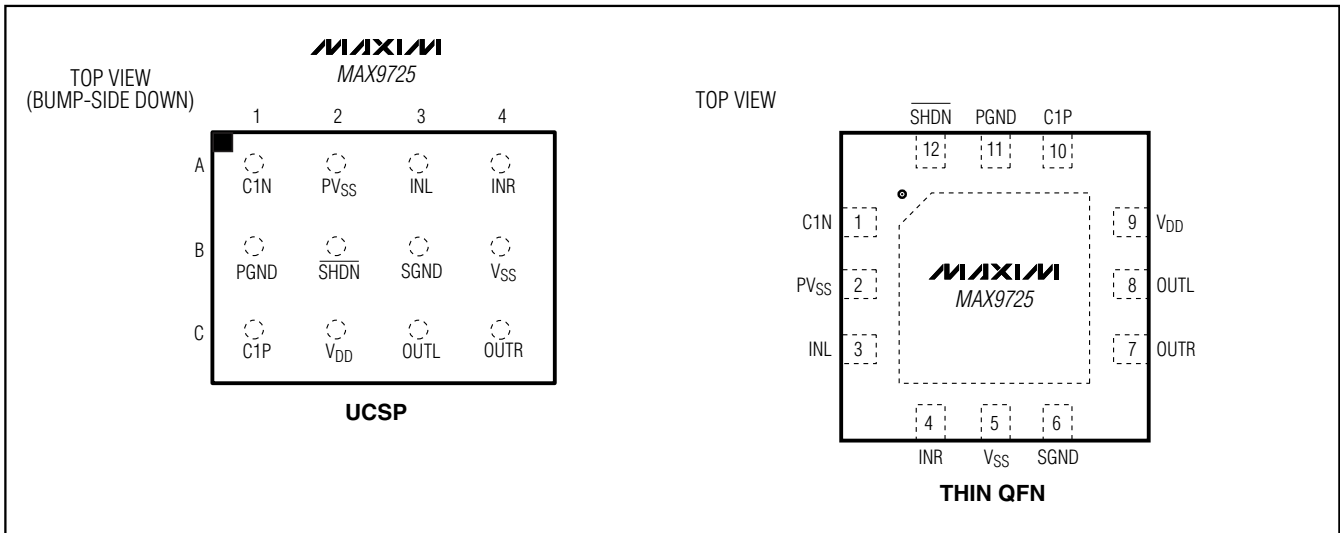

1V, Low-Power, DirectDrive, Stereo Headphone Amplifier with Shutdown

Functional Diagram

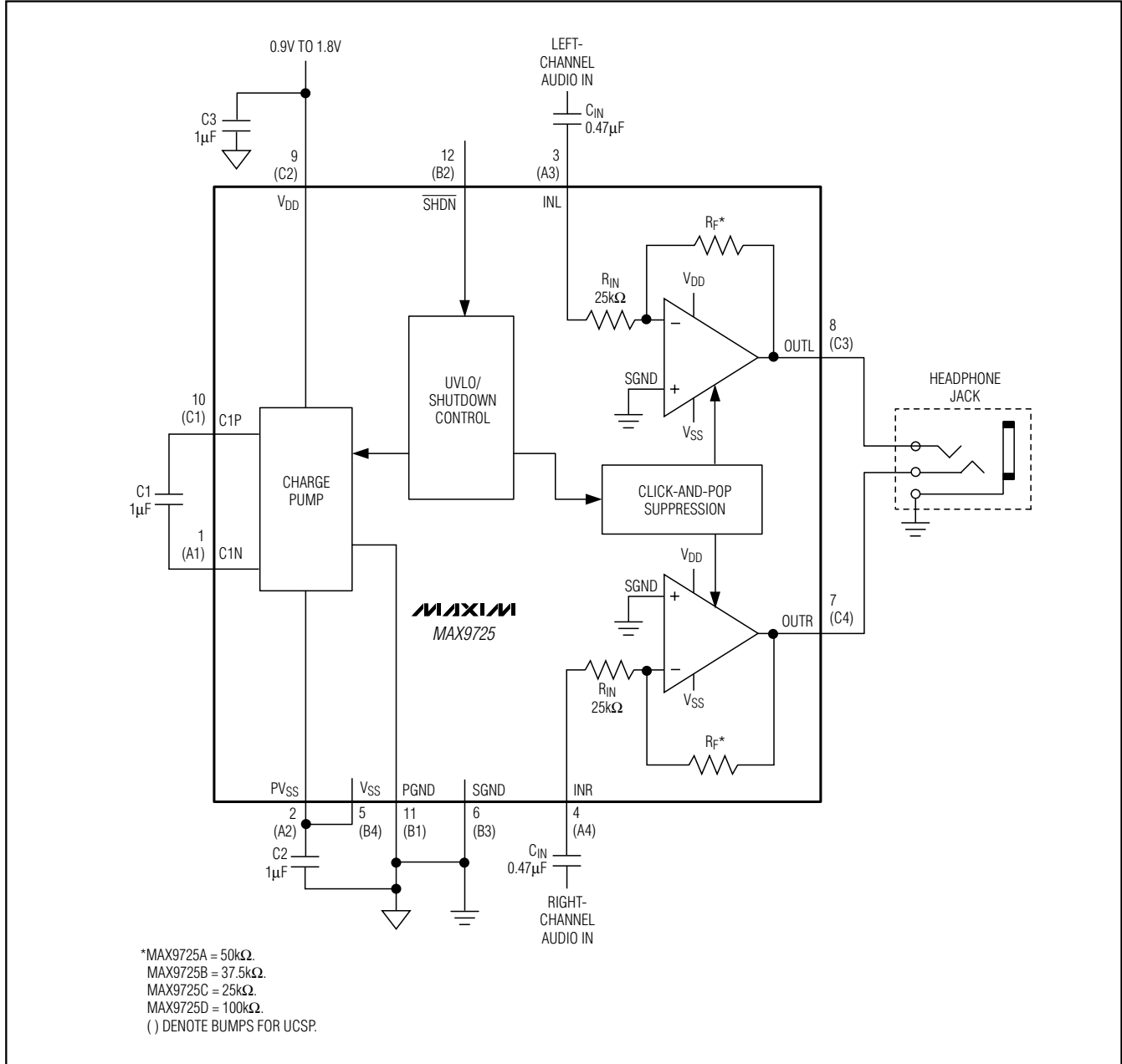

1V, Low-Power, DirectDrive, Stereo Headphone Amplifier with Shutdown

Package Information

(The package drawing(s) in this data sheet may not reflect the most current specifications. For the latest package outline information, go to www.maxim-ic.com/packages.)

MAX9725

TOP VIEW

COMMON DIMENSIONS	
A	0.62±0.05-0.08
A1	0.29±0.02
A2	0.33 REF.
b	∅0.35±0.03
D1	1.00 BASIC
E1	1.50 BASIC
e	0.50 BASIC
SD	0.00 BASIC
SE	0.25 BASIC

PKG. CODE	VARIABLE DIMENSIONS		DEPOPULATED SOLDER BALLS
	D	E	
B12-1	1.54±0.05	2.02±0.05	NONE
B12-2	1.54±0.05	2.02±0.05	B3
B12-3	1.54±0.05	2.12±0.05	NONE
B12-4	1.54±0.05	2.02±0.05	B2, B3
B12-5	1.64±0.05	2.12±0.05	B2
B12-6	1.64±0.05	2.12±0.05	B3
B12-7	1.54±0.05	2.02±0.05	B1, B3
B12-8	1.54±0.05	2.02±0.05	B2
B12-9	1.54±0.05	2.12±0.05	B2, B3
B12-10	1.54±0.05	2.02±0.05	B1, B2, B3, B4
B12-11	1.54±0.05	2.02±0.05	A2, C3

NOTES:

- ALL DIMENSIONS ARE IN MILLIMETERS.
- PRODUCT MARKING: NUMBER OF CHARACTERS AND LINES VARY PER PRODUCT.

BOTTOM VIEW

SIDE VIEW

DALLAS SEMICONDUCTOR **MAXIM**

PROPRIETARY INFORMATION

TITLE:
PACKAGE OUTLINE, 4x3 UCSP

APPROVAL	DOCUMENT CONTROL NO. 21-0104	REV. F 1/1
----------	---------------------------------	---------------

12L, UCSP 4x3.EPS

1V, Low-Power, DirectDrive, Stereo Headphone Amplifier with Shutdown

Package Information (continued)

(The package drawing(s) in this data sheet may not reflect the most current specifications. For the latest package outline information, go to www.maxim-ic.com/packages.)

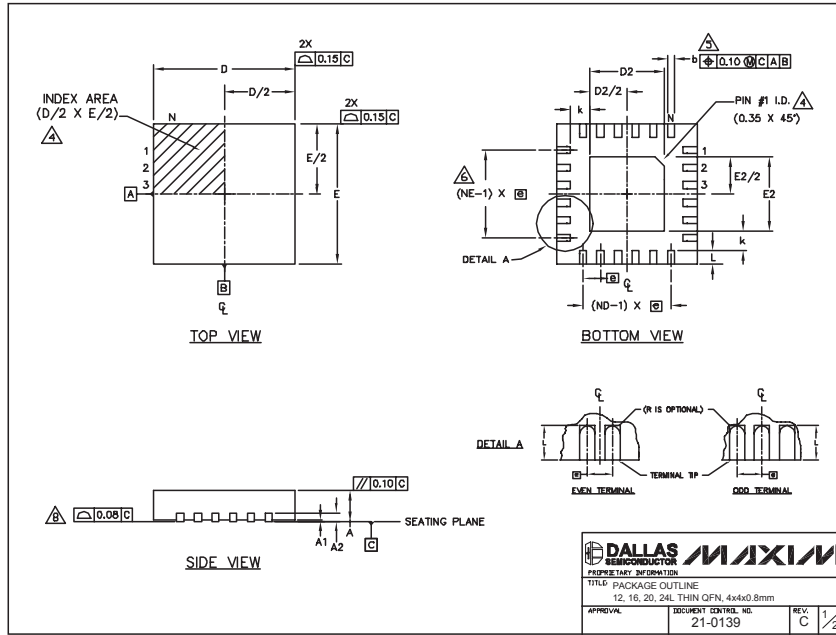

DALLAS SEMICONDUCTOR **MAXIM**
 PROPRIETARY INFORMATION
 TITLE: PACKAGE OUTLINE
 12, 16, 20, 24L THIN OFN, 4x4x0.8mm
 APPROVAL: _____ DOCUMENT CONTROL NO. 21-0139 REV. C 1/2

COMMON DIMENSIONS												
PKG	12L 4x4			16L 4x4			20L 4x4			24L 4x4		
REF.	MIN.	NDM.	MAX.	MIN.	NDM.	MAX.	MIN.	NDM.	MAX.	MIN.	NDM.	MAX.
A	0.70	0.75	0.80	0.70	0.75	0.80	0.70	0.75	0.80	0.70	0.75	0.80
AL	0.0	0.02	0.05	0.0	0.02	0.05	0.0	0.02	0.05	0.0	0.02	0.05
A2	0.20 REF.			0.20 REF.			0.20 REF.			0.20 REF.		
b	0.25	0.30	0.35	0.25	0.30	0.35	0.25	0.25	0.30	0.18	0.23	0.30
D	3.90	4.60	4.10	3.90	4.00	4.10	3.90	4.00	4.10	3.90	4.00	4.10
E	3.90	4.60	4.10	3.90	4.00	4.10	3.90	4.00	4.10	3.90	4.00	4.10
e	0.80 BSC.			0.65 BSC.			0.50 BSC.			0.50 BSC.		
k	0.25	-	-	0.25	-	-	0.25	-	-	0.25	-	-
L	0.45	0.55	0.65	0.45	0.55	0.65	0.45	0.55	0.65	0.30	0.40	0.50
N	12			16			20			24		
ND	3			4			5			6		
NE	3			4			5			6		
JeDEC Var.	VGG8			VGGC			VGGD-1			VGGD-2		

EXPOSED PAD VARIATIONS									
PKG CODES	D2			E2			DOWN ENDS ALLOWED		
	MIN.	NDM.	MAX.	MIN.	NDM.	MAX.			
T1244-2	1.95	2.30	2.25	1.95	2.10	2.25	NO		
T1244-3	1.95	2.30	2.25	1.95	2.10	2.25	YES		
T1244-4	1.95	2.30	2.25	1.95	2.10	2.25	NO		
T1644-2	1.95	2.30	2.25	1.95	2.10	2.25	NO		
T1644-3	1.95	2.30	2.25	1.95	2.10	2.25	YES		
T1644-4	1.95	2.30	2.25	1.95	2.10	2.25	NO		
T2044-1	1.95	2.30	2.25	1.95	2.10	2.25	NO		
T2044-2	1.95	2.30	2.25	1.95	2.10	2.25	YES		
T2044-3	1.95	2.30	2.25	1.95	2.10	2.25	NO		
T2444-1	2.45	2.60	2.63	2.45	2.60	2.63	NO		
T2444-2	1.95	2.30	2.25	1.95	2.10	2.25	YES		
T2444-3	2.45	2.60	2.63	2.45	2.60	2.63	YES		
T2444-4	2.45	2.60	2.63	2.45	2.60	2.63	NO		

NOTES:
 1. DIMENSIONING & TOLERANCING CONFORM TO ASME Y14.5M-1994.
 2. ALL DIMENSIONS ARE IN MILLIMETERS. ANGLES ARE IN DEGREES.
 3. N IS THE TOTAL NUMBER OF TERMINALS.
 4. THE TERMINAL #1 IDENTIFIER AND TERMINAL NUMBERING CONVENTION SHALL CONFORM TO JEDEC 95-1 SFF-012. DETAILS OF TERMINAL #1 IDENTIFIER ARE OPTIONAL, BUT MUST BE LOCATED WITHIN THE ZONE INDICATED. THE TERMINAL #1 IDENTIFIER MAY BE EITHER A MOLD OR MARKED FEATURE.
 5. DIMENSION b APPLIES TO METALLIZED TERMINAL AND IS MEASURED BETWEEN 0.25 mm AND 0.30 mm FROM TERMINAL TIP.
 6. ND AND NE REFER TO THE NUMBER OF TERMINALS ON EACH D AND E SIDE RESPECTIVELY.
 7. DEPOPULATION IS POSSIBLE IN A SYMMETRICAL FASHION.
 8. COPLANARITY APPLIES TO THE EXPOSED HEAT SINK SLUG AS WELL AS THE TERMINALS.
 9. DRAWING CONFORMS TO JEDEC MO220, EXCEPT FOR T2444-1, T2444-3 AND T2444-4.

DALLAS SEMICONDUCTOR **MAXIM**
 PROPRIETARY INFORMATION
 TITLE: PACKAGE OUTLINE
 12, 16, 20, 24L THIN OFN, 4x4x0.8mm
 APPROVAL: _____ DOCUMENT CONTROL NO. 21-0139 REV. C 1/2

Maxim cannot assume responsibility for use of any circuitry other than circuitry entirely embodied in a Maxim product. No circuit patent licenses are implied. Maxim reserves the right to change the circuitry and specifications without notice at any time.