

200-mA LOW-NOISE, HIGH-PSRR NEGATIVE OUTPUT LOW-DROPOUT LINEAR REGULATORS

FEATURES

- **Ultralow Noise:** 60- μV_{RMS} Typical
- **High PSRR:** 65-dB Typical at 1 kHz
- **Low Dropout Voltage:** 280-mV Typical at 200 mA, 2.5 V
- **Available in -2.5 V, and Adjustable (-1.2 V to -10 V) Versions**
- **Stable With a 2.2- μF Ceramic Output Capacitor**
- **Less Than 2- μA Typical Quiescent Current in Shutdown Mode**
- **2% Overall Accuracy (Line, Load, Temperature)**
- **Thermal and Overcurrent Protection**
- **5-Pin SOT-23 (DBV) Package**
- **-40°C to 125°C Operating Junction Temperature Range**

APPLICATIONS

- **Optical Drives**
- **Optical Networking**
- **Noise Sensitive Circuitry**
- **GaAs FET Gate Bias**
- **Video Amplifiers**

DESCRIPTION

The TPS723xx family of low-dropout (LDO) negative voltage regulators offers an ideal combination of features to support low noise applications. The devices are capable of operating with input voltages from -10 V to -2.7 V, and supporting outputs from -10 V to -1.2 V. These regulators are stable with small, low-cost ceramic capacitors, and include enable (EN) and noise reduction (NR) functions. Thermal short-circuit and over-current protections are provided by internal detection and shutdown logic. High PSRR (65 dB at 1 k Hz) and low noise (60 μV_{RMS}) make the TPS723xx ideal for low-noise applications.

The TPS723xx uses a precision voltage reference to achieve 2% overall accuracy over load, line, and temperature variations. Available in a small SOT23-5 package, the TPS723xx family is fully specified over a temperature range of -40°C to 125°C.

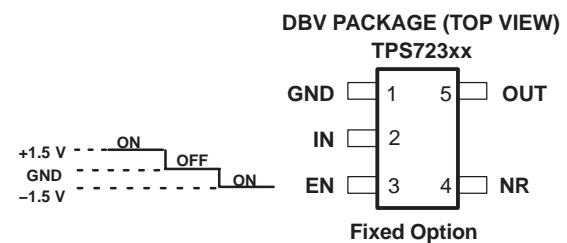
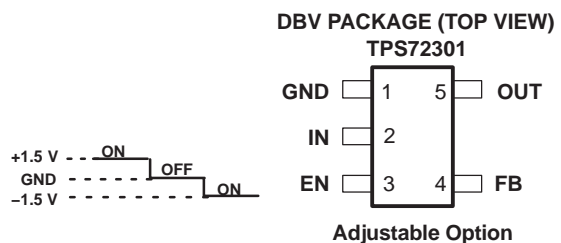
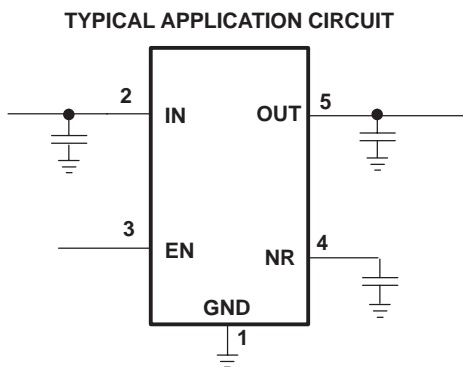

Please be aware that an important notice concerning availability, standard warranty, and use in critical applications of Texas Instruments semiconductor products and disclaimers thereto appears at the end of this data sheet.



These devices have limited built-in ESD protection. The leads should be shorted together or the device placed in conductive foam during storage or handling to prevent electrostatic damage to the MOS gates.

ORDERING INFORMATION

T _J	VOLTAGE ⁽¹⁾	PACKAGE	PART NUMBER		SYMBOL
–40°C to 125°C	Variable –1.2 V to –10 V	SOT-23 (DBV)	TPS72301DBVT ⁽²⁾	TPS72301DBVR ⁽³⁾	TO8I
	–2.5 V		TPS72325DBVT ⁽²⁾	TPS72325DBVR ⁽³⁾	TO2I

(1) Custom output voltages from –1.2 V to –9 V in 100-mV increments are available. Minimum order quantities apply. Contact TI for details and availability.

(2) The DBVT indicates tape and reel of 250 parts.

(3) The DBVR indicates tape and reel of 3000 parts.

ABSOLUTE MAXIMUM RATINGS

over operating temperature range (unless otherwise noted)⁽¹⁾⁽²⁾

	UNITS
Input voltage range, V _{IN}	–11 V to 0.3 V
Enable voltage range, V _(EN)	–V _I to 5 V
Output voltage range, V _{OUT}	–11 + V _{DO}
Output current, I _{OUT}	Internally limited
Output short-circuit duration	Indefinite
Continuous total power dissipation, P _D	See Dissipation Rating Table
Junction temperature range, T _J	–55°C to 150°C
Storage temperature range, T _{stg}	–65°C to 150°C
ESD rating, HBM	2 kV

(1) Stresses beyond those listed under *absolute maximum ratings* may cause permanent damage to the device. These are stress ratings only, and functional operation of the device at these or any other conditions beyond those indicated under “recommended operating conditions” is not implied. Exposure to absolute-maximum-rated conditions for extended periods may affect device reliability.

(2) All voltage values are with respect to network ground terminal.

RECOMMENDED OPERATING CONDITIONS

	MIN	NOM	MAX	UNIT
Input voltage range, V _{IN}	–10		–2.7	V
Output voltage range, V _{OUT}	–10 + V _{DO}		–1.2	V
Operating junction temperature, T _J	–40		125	°C

ELECTRICAL CHARACTERISTICS

 over operating junction temperature range, $V_{IN} = V_{OUT(nom)} - 0.5\text{ V}$, $I_{OUT} = 1\text{ mA}$, $V_{(EN)} = 1.5\text{ V}$, $C_{OUT} = 2.2\text{ }\mu\text{F}$, $C_{(NR)} = 0.01\text{ }\mu\text{F}$ (unless otherwise noted). Typical values are at 25°C

PARAMETER		TEST CONDITIONS		MIN	TYP	MAX	UNIT
V_{IN}	Input voltage range ⁽¹⁾			-10		-2.7	V
$V_{(FB)}$	Feedback reference voltage	TPS72301	$T_J = 25^\circ\text{C}$	-1.210	-1.186	-1.162	V
V_{OUT}	Output voltage range	TPS72301		$-10 + V_{DO}$		$V_{(FB)}$	V
	Accuracy	Nominal	$T_J = 25^\circ\text{C}$	-1%		1%	
		TPS72325 vs $V_{IN}/I_{OUT}/T$	$-10\text{ V} < V_{IN} < V_{OUT} - 0.5\text{ V}$, $10\text{ }\mu\text{A} < I_{OUT} < 200\text{ mA}$	-2%		$\pm 1\%$	2%
		TPS72301 vs $V_{IN}/I_{OUT}/T$		-3%		$\pm 1\%$	3%
V_{OUT}/V_{IN}	Line regulation		$-10\text{ V} < V_{IN} < V_{OUT(nom)} - 0.5\text{ V}$		0.04	%/V	
V_{OUT}/I_{OUT}	Load regulation		$0\text{ mA} < I_O < 200\text{ mA}$		0.002	%/mA	
V_{DO}	Dropout voltage at $V_{OUT} = 0.96 \times V_{OUT(nom)}$	TPS72325	$I_{OUT} = 200\text{ mA}$		280	500	mV
$I_{(CL)}$	Current limit		$V_{OUT} = 0.85 \times V_{OUT(nom)}$	300	550	800	mA
$I_{(GND)}$	Ground pin current		$I_{OUT} = 0\text{ mA}$, (I_Q) $-10\text{ V} < V_{IN} < V_{OUT} - 0.5\text{ V}$		130	200	μA
			$I_{OUT} = 200\text{ mA}$, $-10\text{ V} < V_{IN} < V_{OUT} - 0.5\text{ V}$		350	500	
$I_{(SHDN)}$	Shutdown ground pin current		$-0.4\text{ V} < V_{(EN)} < 0.4\text{ V}$, $-10\text{ V} < V_{IN} < V_{OUT} - 0.5\text{ V}$		0.1	2.0	μA
$I_{(FB)}$	Feedback pin current		$-10\text{ V} < V_{IN} < V_{OUT} - 0.5\text{ V}$		0.05	1.0	μA
PSRR	Power supply rejection ratio	TPS72325	$I_{OUT} = 200\text{ mA}$, 1 kHz, $C_{IN} = C_{OUT} = 10\text{ }\mu\text{F}$		65		dB
			$I_{OUT} = 200\text{ mA}$, 10 kHz, $C_{IN} = C_{OUT} = 10\text{ }\mu\text{F}$		48		
V_n	Output noise voltage	TPS72325	$C_{OUT} = 10\text{ }\mu\text{F}$, 10 Hz = 100 kHz, $I_{OUT} = 200\text{ mA}$		60		μV_{rms}
$t_{(STR)}$	Startup time		$V_{OUT} = -2.5\text{ V}$, $C_{OUT} = 1\text{ }\mu\text{F}$, $R_L = 25\text{ }\Omega$		1		ms
$V_{EN(hi)}$	Enable threshold positive			1.5			V
$V_{EN(lo)}$	Enable threshold negative					-1.5	V
$V_{DIS(hi)}$	Disable threshold positive					0.4	V
$V_{DIS(lo)}$	Disable threshold negative			-0.4			V
$I_{(EN)}$	Enable pin current		$-10\text{ V} \leq V_{IN} \leq V - 0.5\text{ V}$, $-10\text{ V} \leq V_{(EN)} \leq \pm 3.5\text{ V}$		0.1	2.0	μA
	Thermal shutdown temperature		Shutdown, temperature increasing		165		$^\circ\text{C}$
			Reset, temperature decreasing		145		
T_J	Operating junction temperature			-40		125	$^\circ\text{C}$

⁽¹⁾ Maximum $V_{IN} = V_{OUT} + V_{DO}$ or -2.7 V , whichever is more negative.

FUNCTIONAL BLOCK DIAGRAM

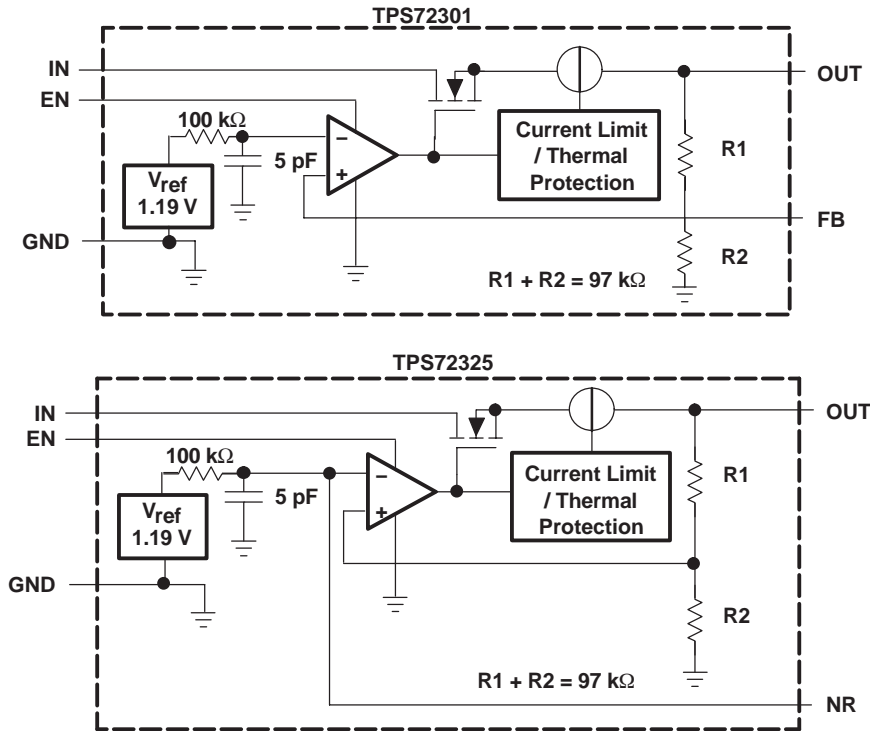

Terminal Functions

TERMINAL NAME	NO.	DESCRIPTION
GND	1	Ground
VIN	2	Unregulated input supply
EN	3	Bipolar enable pin. Driving this pin above the positive enable threshold or below the negative enable threshold turns on the regulator. Driving this pin below the positive disable threshold and above the negative disable threshold puts the regulator into shutdown mode.
NR	4	Fixed voltage versions only. Connecting an external capacitor between this pin and ground, bypasses noise generated by the internal bandgap. This allows output noise to be reduced to very low levels.
FB	4	Adjustable voltage version only. This is the input to the control loop error amplifier. It is used to set the output voltage of the device
VOUT	5	Regulated output voltage. A small 2.2 μF ceramic capacitor is needed from this pin to GND to ensure stability.

TYPICAL CHARACTERISTICS

(TPS72325 $V_{IN} = V_{OUT(nom)} - 0.5\text{ V}$, $I_{OUT} = 1\text{ mA}$, $V_{(EN)} = 1.5\text{ V}$, $C_{OUT} = 2.2\text{ }\mu\text{F}$, $C_{(NR)} = 0.01\text{ }\mu\text{F}$ unless otherwise noted)

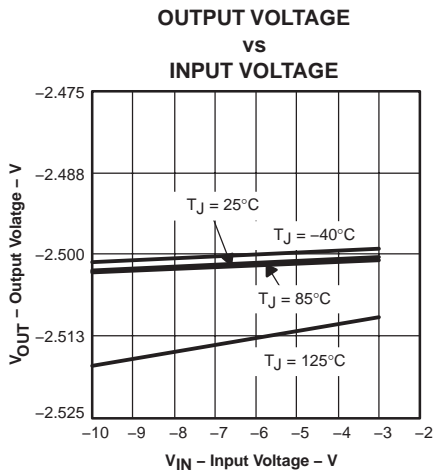

Figure 1

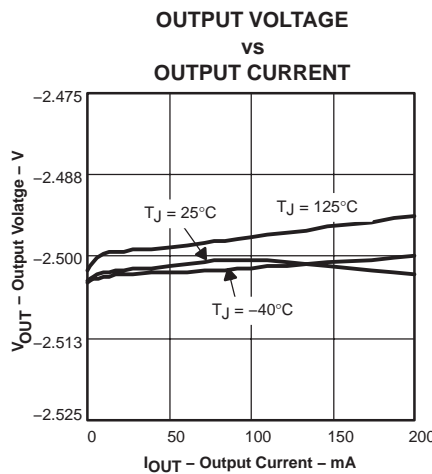

Figure 2

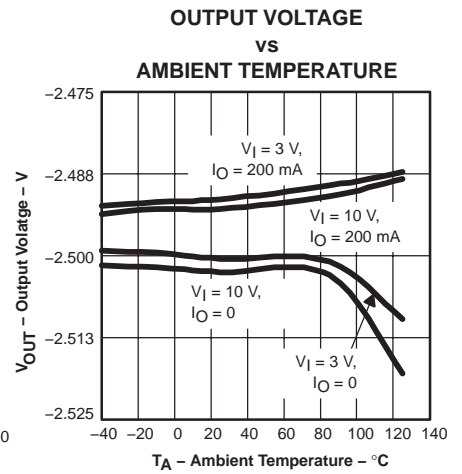

Figure 3

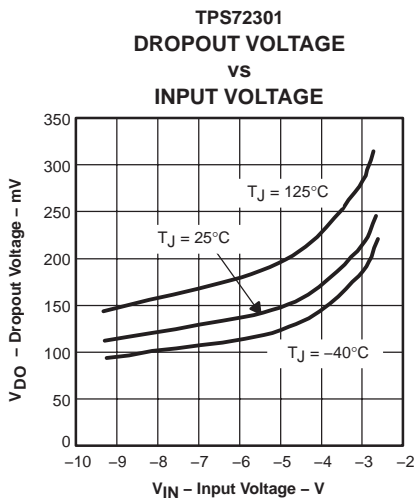

Figure 4

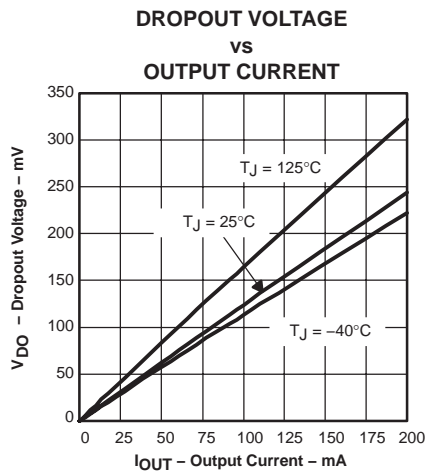

Figure 5

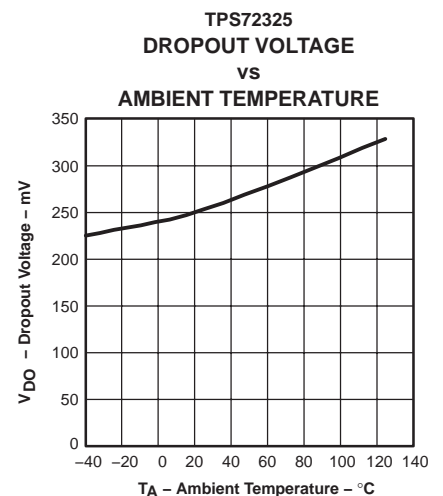

Figure 6

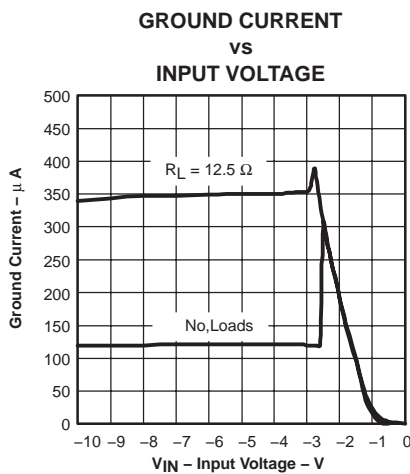

Figure 7

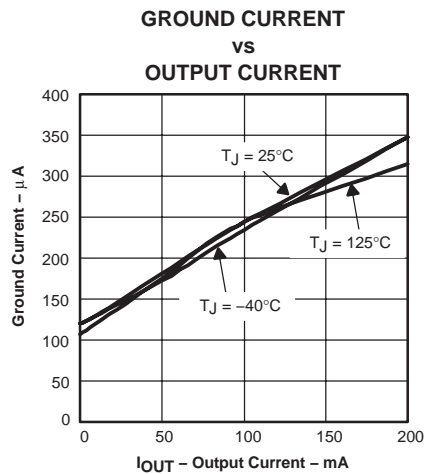

Figure 8

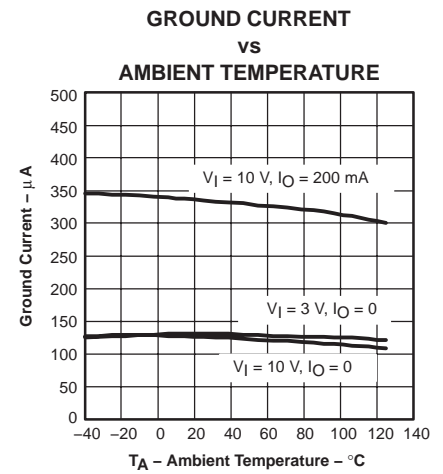
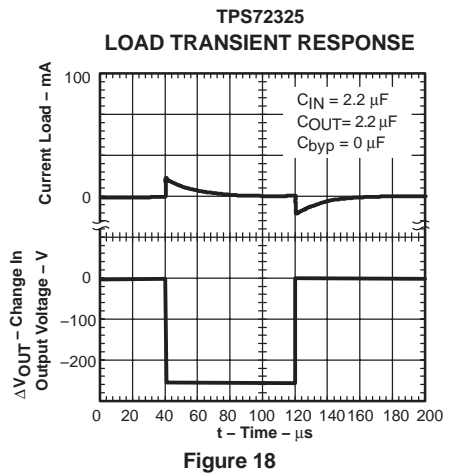
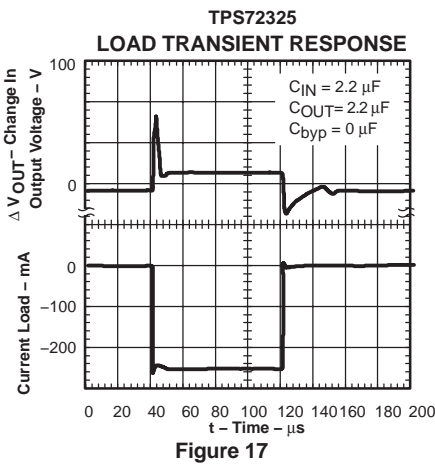
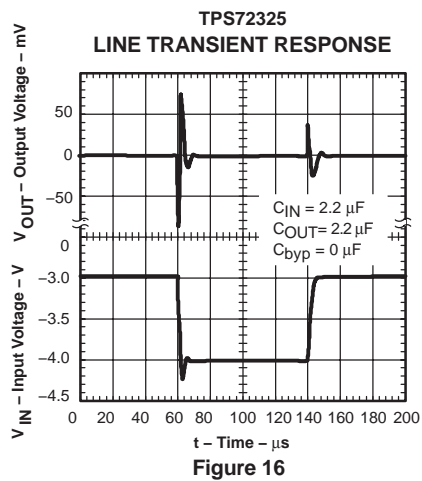
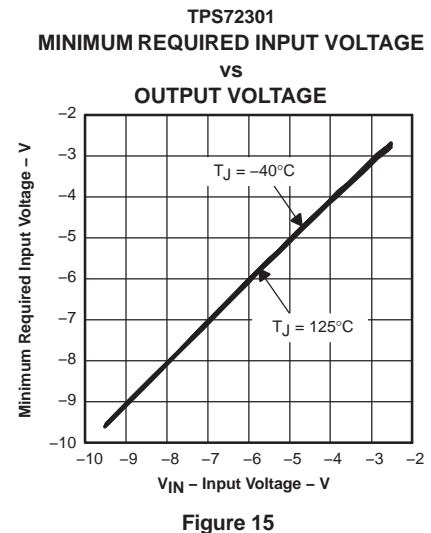
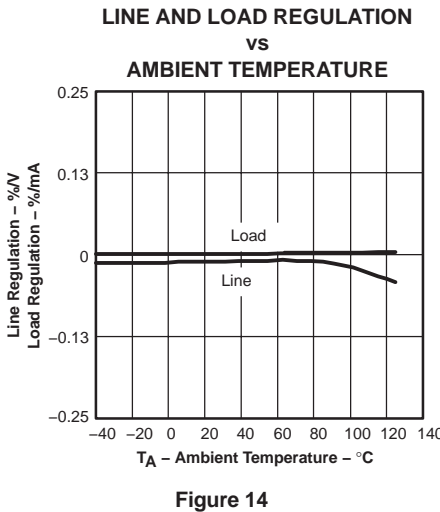
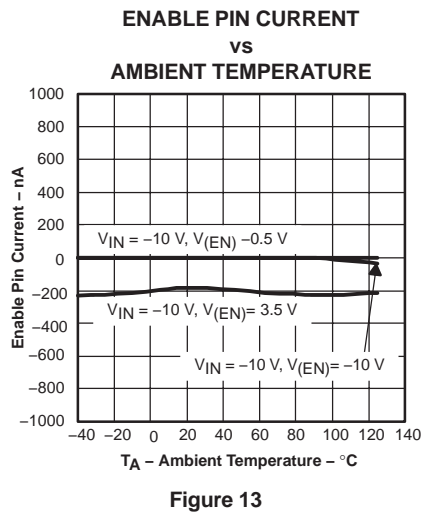
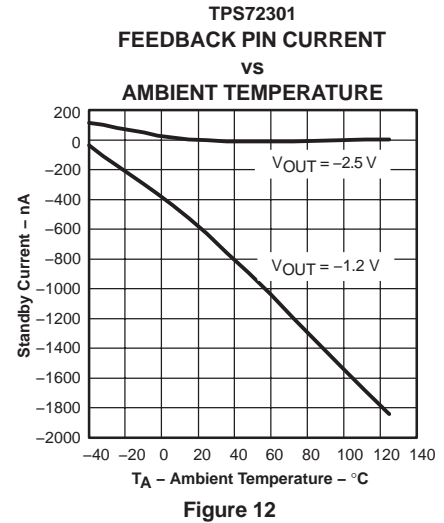
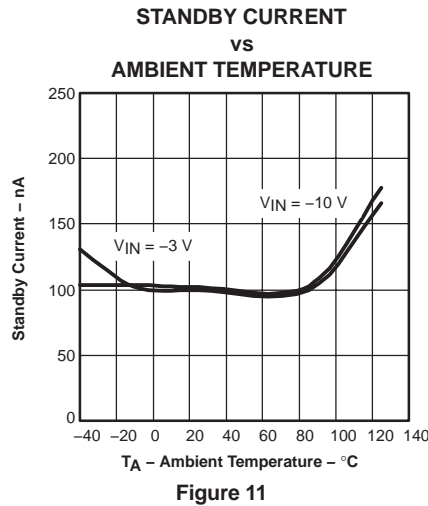
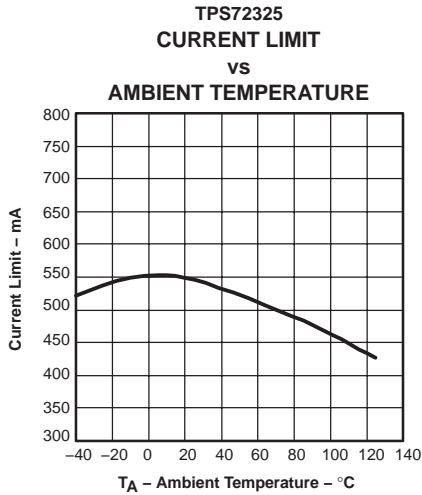

Figure 9



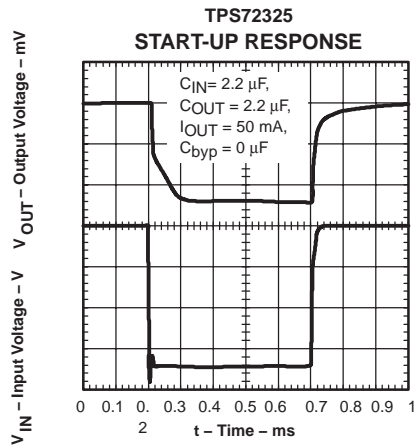

Figure 19

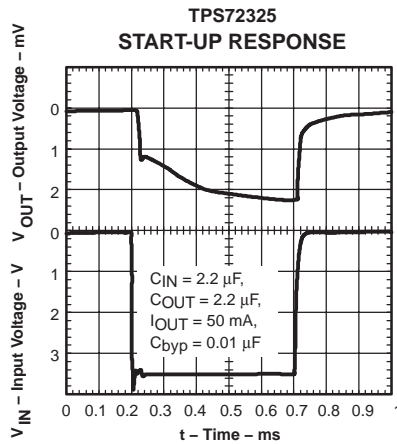

Figure 20

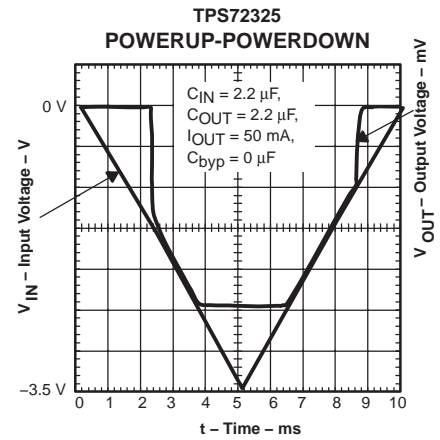

Figure 21

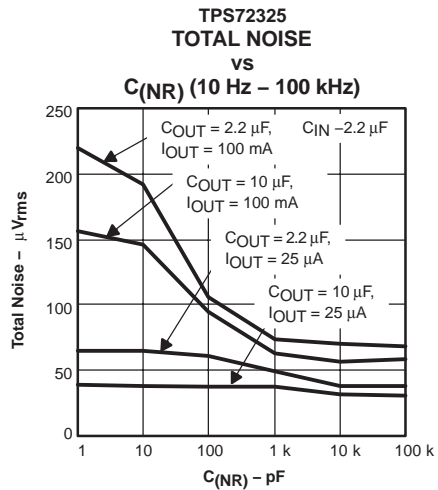

Figure 22

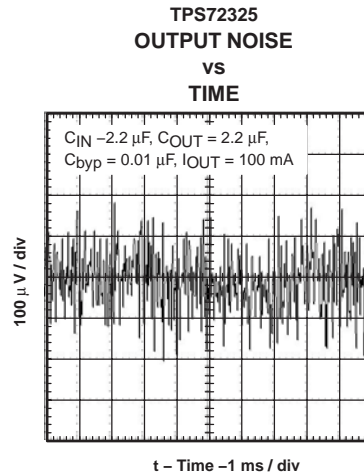

Figure 23

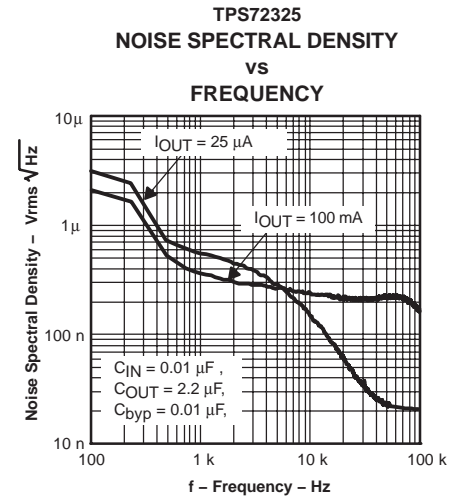

Figure 24

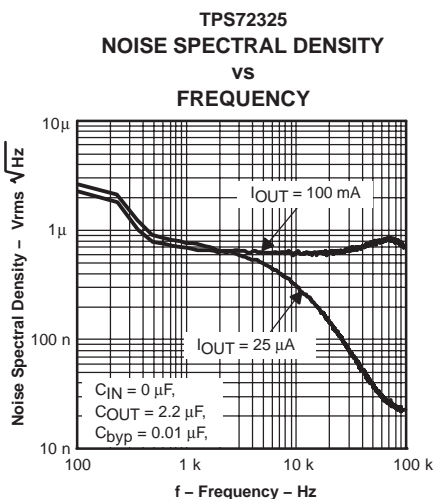

Figure 25

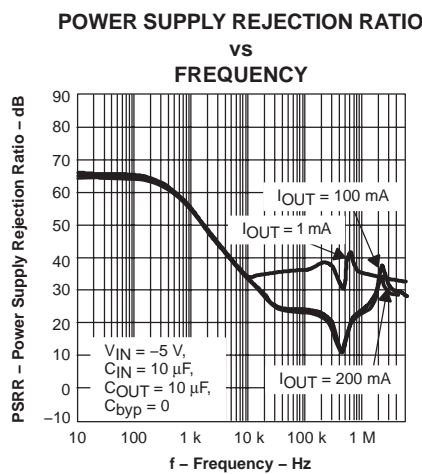

Figure 26

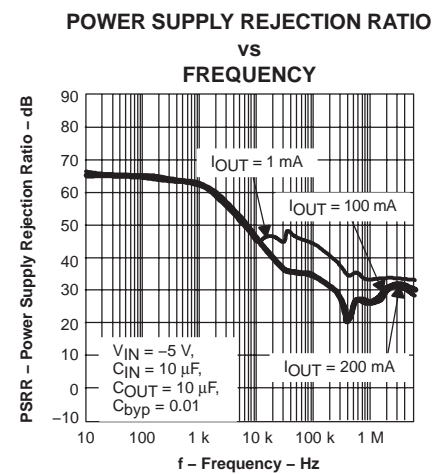

Figure 27

APPLICATION INFORMATION

DEVICE OPERATION

The TPS723xx is a low-dropout negative linear voltage regulator with a rated current of 200 mA. It is offered in trimmed output voltages between -1.5 V and -5.2 V and as an adjustable regulator from -1.2 V to -10 V. It features very low noise and high PSRR making it ideal for high sensitivity analog and RF applications. A shutdown mode is available, reducing ground current to 2 μ A maximum over temperature and process. The TPS723xx is offered in a small SOT23 package and is specified over a -40°C to 125°C temperature range.

ENABLE

The enable pin is active above 1.5 V and below -1.5 V, allowing it to be controlled by a standard TTL signal or by connection to V_I if not used. When driven to GND most internal circuitry is turned off, putting the TPS723xx into shutdown mode, drawing 2 μ A maximum ground current.

ADJUSTABLE VOLTAGE APPLICATIONS

The TPS72301 allows designers to specify any output voltage from -10 V to -1.2 V. As shown in the application circuit in Figure 28, an external resistor divider is used to scale the output voltage V_O to the reference voltage 1.186 V. For best accuracy, use precision resistors for R_1 and R_2 .

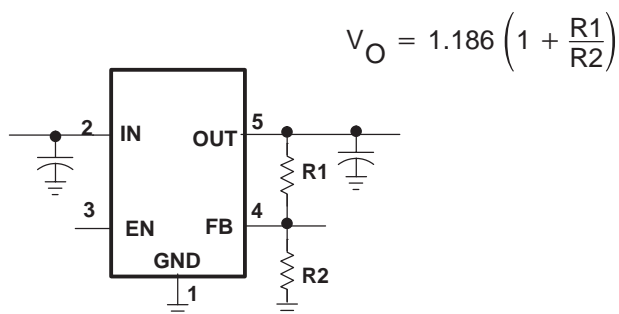

Figure 28. TPS72301 Adjustable LDO Regulator Programming

CAPACITOR SELECTION FOR STABILITY

Appropriate input and output capacitors should be used for the intended application. The TPS723xx only requires a 2.2 - μF ceramic output capacitor to be used for stable operation. Both the capacitor value and ESR affect stability, output noise, PSRR, and transient response. For typical applications, a 2.2 - μF ceramic output capacitor located close to the regulator is sufficient.

OUTPUT NOISE

Without external bypassing, output noise of the TPS723xx from 10 Hz to 100 kHz is 200 μV_{RMS} typical. The dominant contributor to output noise is the internal bandgap reference. Adding an external 0.01 - μF capacitor to ground reduces noise to 60 μV_{RMS} . Best noise performance is achieved using appropriate low ESR capacitors for bypassing noise at the NR and VOUT pins. See the Noise vs C_{OUT} plot in the Typical Characteristics section.

POWER SUPPLY REJECTION

The TPS723xx offers a very high power supply rejection ratio (PSRR) for applications with noisy input sources or highly sensitive output supply lines. For best PSRR, use high quality input and output capacitors.

CURRENT LIMIT

The TPS723xx has internal circuitry that monitors and limits output current to protect the regulator from damage under all load conditions. When output current reaches the output current limit (550 mA typical), protection circuitry turns on, reducing output voltage to ensure current does not increase. See Current Limit in the Typical Characteristics section.

THERMAL PROTECTION

As protection from damage due to excessive junction temperatures, the TPS723xx has internal protection circuitry. When junction temperature reaches approximately 165°C , the output device is turned off. After the device has cooled by about 20°C , the output device is enabled, allowing normal operation. For reliable operation, design is for worst case junction temperature of $\leq 125^{\circ}\text{C}$ taking into account worst case ambient temperature and load conditions.

DBV (R-PDSO-G5)

PLASTIC SMALL-OUTLINE PACKAGE

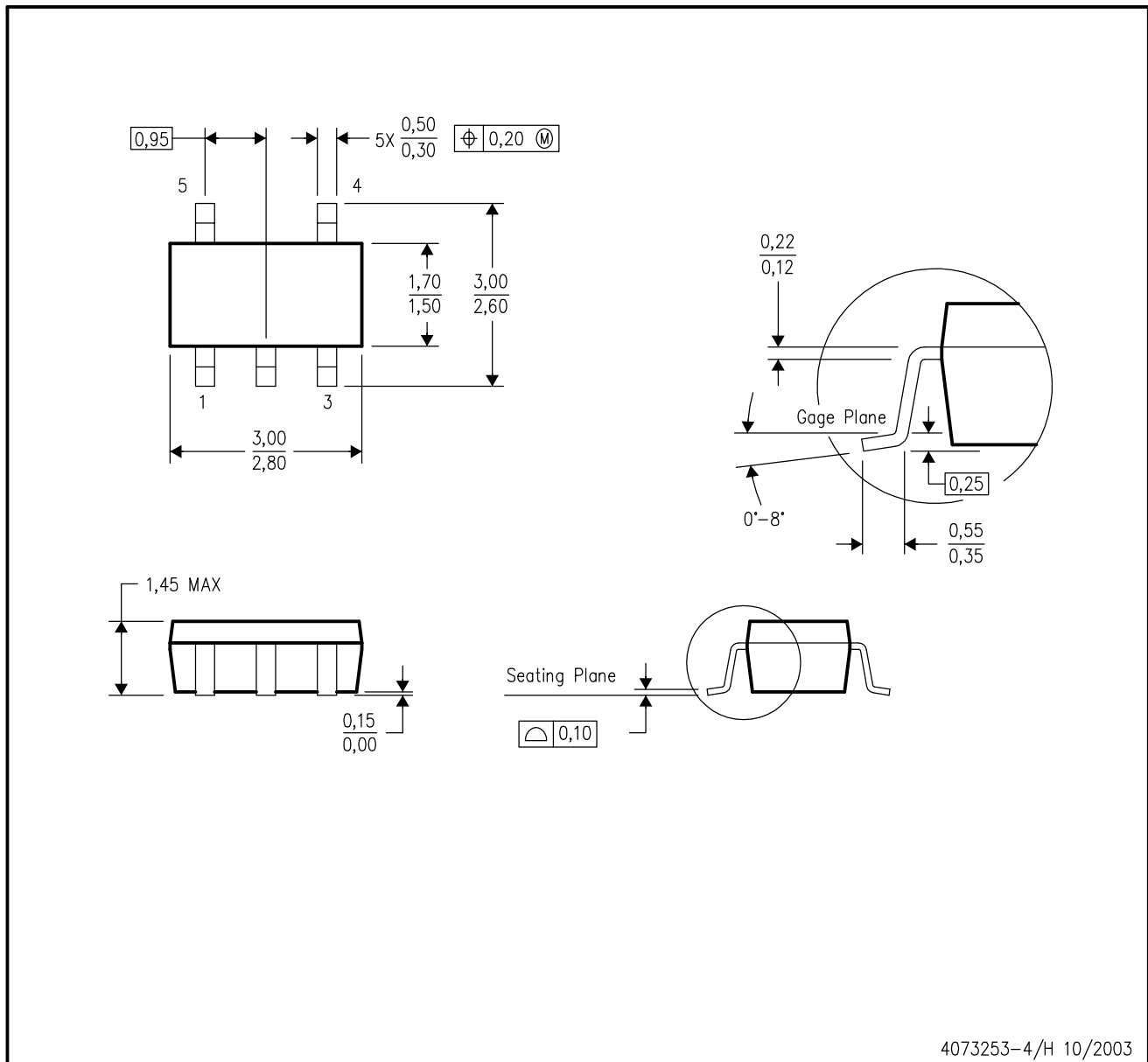

- NOTES:
- A. All linear dimensions are in millimeters.
 - B. This drawing is subject to change without notice.
 - C. Body dimensions do not include mold flash or protrusion.
 - D. Falls within JEDEC MO-178 Variation AA.

IMPORTANT NOTICE

Texas Instruments Incorporated and its subsidiaries (TI) reserve the right to make corrections, modifications, enhancements, improvements, and other changes to its products and services at any time and to discontinue any product or service without notice. Customers should obtain the latest relevant information before placing orders and should verify that such information is current and complete. All products are sold subject to TI's terms and conditions of sale supplied at the time of order acknowledgment.

TI warrants performance of its hardware products to the specifications applicable at the time of sale in accordance with TI's standard warranty. Testing and other quality control techniques are used to the extent TI deems necessary to support this warranty. Except where mandated by government requirements, testing of all parameters of each product is not necessarily performed.

TI assumes no liability for applications assistance or customer product design. Customers are responsible for their products and applications using TI components. To minimize the risks associated with customer products and applications, customers should provide adequate design and operating safeguards.

TI does not warrant or represent that any license, either express or implied, is granted under any TI patent right, copyright, mask work right, or other TI intellectual property right relating to any combination, machine, or process in which TI products or services are used. Information published by TI regarding third-party products or services does not constitute a license from TI to use such products or services or a warranty or endorsement thereof. Use of such information may require a license from a third party under the patents or other intellectual property of the third party, or a license from TI under the patents or other intellectual property of TI.

Reproduction of information in TI data books or data sheets is permissible only if reproduction is without alteration and is accompanied by all associated warranties, conditions, limitations, and notices. Reproduction of this information with alteration is an unfair and deceptive business practice. TI is not responsible or liable for such altered documentation.

Resale of TI products or services with statements different from or beyond the parameters stated by TI for that product or service voids all express and any implied warranties for the associated TI product or service and is an unfair and deceptive business practice. TI is not responsible or liable for any such statements.

Following are URLs where you can obtain information on other Texas Instruments products and application solutions:

Products		Applications	
Amplifiers	amplifier.ti.com	Audio	www.ti.com/audio
Data Converters	dataconverter.ti.com	Automotive	www.ti.com/automotive
DSP	dsp.ti.com	Broadband	www.ti.com/broadband
Interface	interface.ti.com	Digital Control	www.ti.com/digitalcontrol
Logic	logic.ti.com	Military	www.ti.com/military
Power Mgmt	power.ti.com	Optical Networking	www.ti.com/opticalnetwork
Microcontrollers	microcontroller.ti.com	Security	www.ti.com/security
		Telephony	www.ti.com/telephony
		Video & Imaging	www.ti.com/video
		Wireless	www.ti.com/wireless

Mailing Address: Texas Instruments
Post Office Box 655303 Dallas, Texas 75265

Copyright © 2003, Texas Instruments Incorporated