

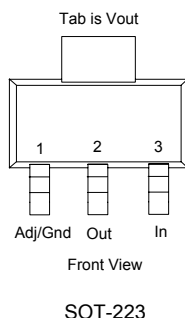

## Description

The SE8117 series of high performance low dropout voltage regulators are designed for applications that require efficient conversion and fast transient response.

## Pin Configuration



## Features

- Low Dropout Performance.
- Guaranteed 1A Output Current.
- Wide Input Supply Voltage Range.
- Over-temperature and Over-current Protection.
- Fixed or Adjustable Output Voltage.
- Rugged 3KV ESD withstand capability.
- Available in SOT-223 Packages.

## Application

- Active SCSI Terminators.
- High Efficiency Linear Regulators.
- 5V to 3.3V Linear Regulators
- Motherboard Clock Supplies.

## Ordering Information

Device	Package	V <sub>OUT</sub> Volts
SE8117TA	SOT-223	Output voltage is adjustable.
SE8117TXX	SOT-223	XX denotes voltage options. Available voltages are 1.5V, 1.8V, 2.5V, 3.0V, and 3.3V.

## Absolute Maximum Rating

Symbol	Parameter	Maximum	Units
V <sub>IN</sub>	Input Supply Voltage	9	V
θ <sub>JC</sub>	Thermal Resistance Junction to Case SOT-223	15	°C/W
θ <sub>JA</sub>	Thermal Resistance Junction to Ambient SOT-223	156	°C/W
T <sub>J</sub>	Operating Junction Temperature Range	0 to 125	°C
T <sub>STG</sub>	Storage Temperature Range	-40 to 150	°C
T <sub>LEAD</sub>	Lead Temperature (Soldering 10 Sec)	260	°C



**Electrical Characteristic**

$V_{IN,MAX} \leq 8V$ ,  $V_{IN,MIN} - V_{OUT} = 1.5V$ ,  $I_{OUT} = 10mA$ ,  $C_{IN} = 10\mu F$ ,  $C_{OUT} = 22\mu F$ ,  $T_J = 0 - 125^\circ C$ , unless otherwise specified.

Symbol	Parameter	Test Condition	Min	Typ	Max	Units
$V_O$	Output Voltage <sup>(1)</sup>	$10mA \leq I_{OUT} \leq 1A$ , $T_A = 25^\circ C$ , SE8117T15 SE8117T18 SE8117T25 SE8117T30 SE8117T33	(-2%)	1.5 1.8 2.5 3.0 3.3	(+2%)	V
$V_{REF}$	Reference Voltage <sup>(1)</sup> (Adj. Voltage Version)	$10mA \leq I_{OUT} \leq 1A$	1.225 (-2%)	1.250	1.275 (+2%)	V
$V_{SR}$	Line Regulation <sup>(1)</sup>	$I_{OUT} = 10mA$		0.3		%
$V_{LR}$	Load Regulation <sup>(1)</sup>	$(V_{IN} - V_{OUT}) = 2V$ $10mA \leq I_{OUT} \leq 1A$		0.4		%
$I_Q$	Quiescent Current			9		mA
$I_{ADJ}$	Adjust Pin Current			48		$\mu A$
$\Delta I_{ADJ}$	Adjust Pin Current Change	$10mA \leq I_{OUT} \leq 1A$		0.2		$\mu A$
$V_D$	Dropout Voltage <sup>(2)</sup>	$\Delta V_{REF} = 1\%$ , $I_{OUT} = 1A$		1.1		V
$I_O$	Minimum Load Current			4		mA
$I_{CL}$	Current Limit			1.8		A
$T_C$	Temperature Coefficient			0.07		%/ $^\circ C$
OTP	Thermal Protection			175		$^\circ C$
$V_N$	RMS Output Noise	$T_A = 25^\circ C$ , $10Hz \leq f \leq 10kHz$		0.003		% $V_O$
$R_A$	Ripple Rejection Ratio	$f = 120Hz$ , $C_{OUT} = 22\mu F$ (Tantalum), $(V_{IN} - V_{OUT}) = 3V$ , $I_{OUT} = 1A$		72		dB

Notes:

1. Low duty cycle pulse testing with which  $T_J$  remains unchanged.
2.  $\Delta V_{OUT}$ ,  $\Delta V_{REF} = 1\%$ .



**Typical Applications**

**Adjustable Voltage Regulator**

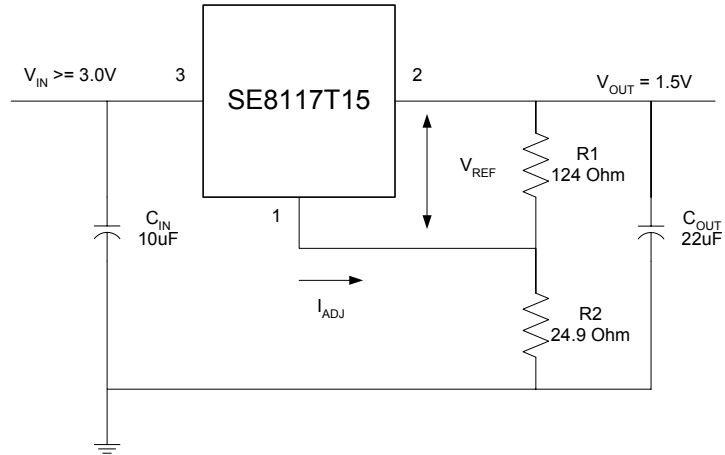

**Fixed Voltage Regulator**

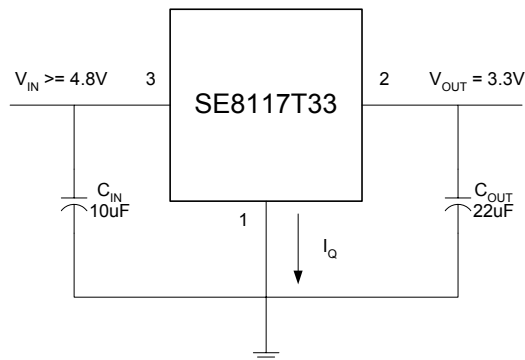



## Typical Performance Characteristics

Reference Voltage vs Junction Temperature

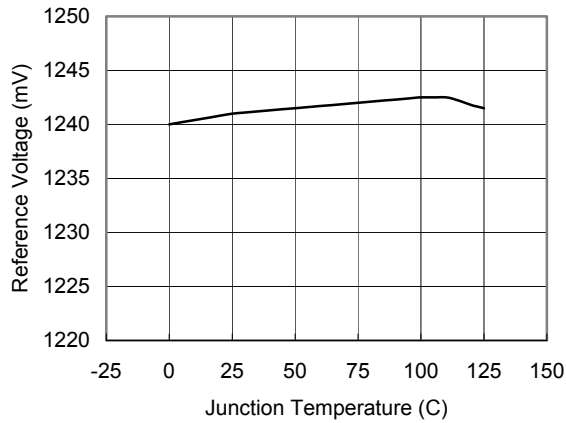

Line Transients

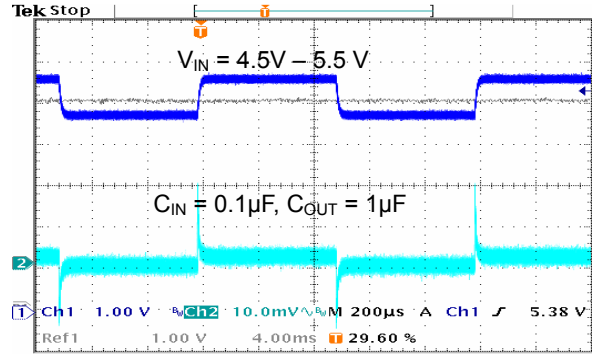

Output Voltage vs Junction Temperature

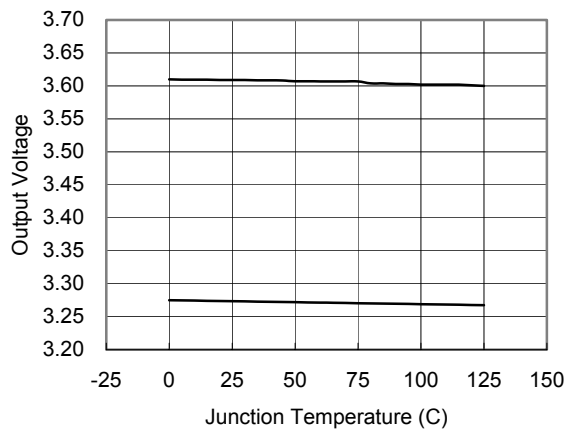

Load Transients

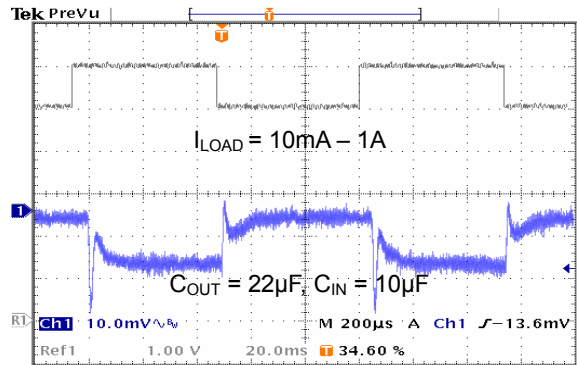

Dropout Voltage vs Output Current

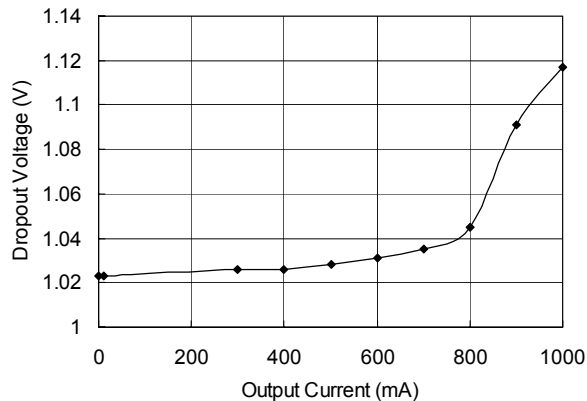



**Outline Drawing for SOT-223**

