

M54522WP

8-UNIT 400mA DARLINGTON TRANSISTOR ARRAY WITH CLAMP DIODE

DESCRIPTION

M54522WP is an eight-circuit Darlington transistor arrays with clamping diodes. The circuits are made of NPN transistors. Both the semiconductor integrated circuits perform high-current driving with extremely low input-current supply.

FEATURES

- High breakdown voltage ($BV_{CEO} \geq 40V$)
- High-current driving ($I_{c(max)} = 400mA$)
- With clamping diodes
- Driving available with PMOS IC output

APPLICATIONS

Drives of relays and printers, digit drives of indication elements (LEDs and lamps), and interfaces between microcomputer output and high-current or high-voltage systems

FUNCTION

The M54522WP each have eight circuits consisting of NPN Darlington transistors. This ICs have resistance of $20k\Omega$ between input transistor bases and input pins.

A spike-killer clamping diode is provided between each output pin (collector) and COM pin. The output transistor emitters are all connected to the GND pin (pin 9).

The collector current is 400mA maximum. Collector-emitter supply voltage is 40V maximum.

PIN CONFIGURATION

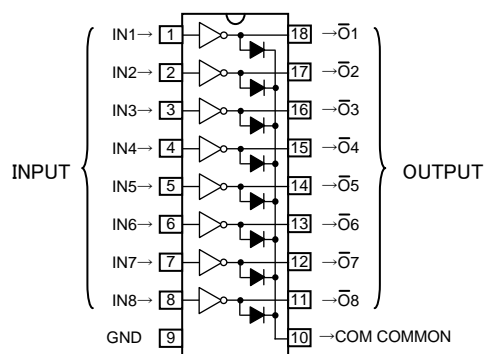

Package type 18P4X

CIRCUIT DIAGRAM

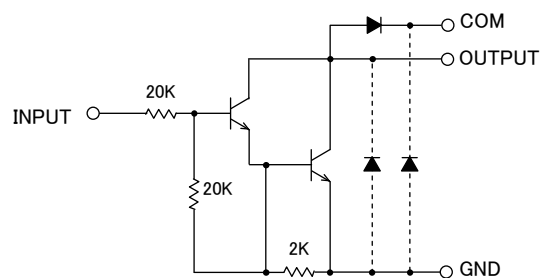

The eight circuits share the COM and GND.
The diode, indicated with the dotted line, is parasitic, and cannot be used.

Unit: Ω

ABSOLUTE MAXIMUM RATINGS (Unless otherwise noted, $T_a = -20 \sim +75^\circ C$)

Symbol	Parameter	Conditions	Ratings	Unit
V_{CEO}	Collector-emitter voltage	Output, H	-0.5 ~ +40	V
I_c	Output current	Current per circuit output, L	400	mA
V_i	Input voltage		-0.5 ~ +40	V
I_F	Clamping diode forward current		400	mA
V_R	Clamping diode reverse voltage		40	V
P_d	Power dissipation	$T_a = 25^\circ C$, when mounted on board	1.79	W
T_{opr}	Operating temperature		-20 ~ +75	$^\circ C$
T_{stg}	Storage temperature		-55 ~ +125	$^\circ C$

8-UNIT 400mA DARLINGTON TRANSISTOR ARRAY WITH CLAMP DIODE

RECOMMENDED OPERATING (Unless otherwise noted, Ta = -20 ~ +75°C)

Symbol	Parameter		Limits			Unit
			min	typ	max	
Vo	Output voltage		0	—	40	V
Ic	Collector current (Current per 1 circuit when 8 circuits are coming on simultaneously)	Duty Cycle no more than 7%	0	—	400	mA
		Duty Cycle no more than 30%	0	—	200	
VIH	“H” input voltage	Ic ≤ 400mA	8	—	30	V
		Ic ≤ 200mA	4	—		
VIL	“L” input voltage		0	—	0.5	V

ELECTRICAL CHARACTERISTICS (Unless otherwise noted, Ta = -20 ~ +75°C)

Symbol	Parameter	Test conditions	Limits			Unit
			min	typ*	max	
V(BR)CEO	Collector-emitter breakdown voltage	ICEO = 100 μA	40	—	—	V
VCE(sat)	Collector-emitter saturation voltage	VI = 8V, IC = 400mA	—	1.15	2.4	V
		VI = 4V, IC = 200mA	—	0.95	1.6	
Ii	Input current	VI = 17V	0.3	0.85	1.8	mA
VF	Clamping diode forward voltage	IF = 400mA	—	1.5	2.4	V
IR	Clamping diode reverse current	VR = 40V	—	—	100	μA
hFE	DC amplification factor	VCE = 4V, IC = 300mA, Ta = 25°C	1000	8000	—	—

*: The typical values are those measured under ambient temperature (Ta) of 25°C. There is no guarantee that these values are obtained under any conditions.

SWITCHING CHARACTERISTICS (Unless otherwise noted, Ta = 25°C)

Symbol	Parameter	Test conditions	Limits			Unit
			min	typ	max	
ton	Turn-on time	CL = 15pF (note 1)	—	30	—	ns
toff	Turn-off time		—	930	—	ns

NOTE 1 TEST CIRCUIT

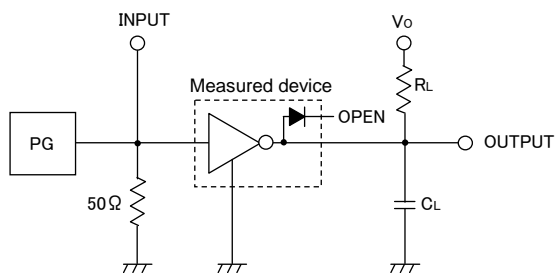

- (1) Pulse generator (PG) characteristics: PRR = 1kHz, tw = 10 μs, tr = 6ns, tf = 6ns, Zo = 50Ω, VIN = 0 to 8V
- (2) Input-output conditions : RL = 25Ω, Vo = 10V
- (3) Electrostatic capacity CL includes floating capacitance at connections and input capacitance at probes

TIMING DIAGRAM

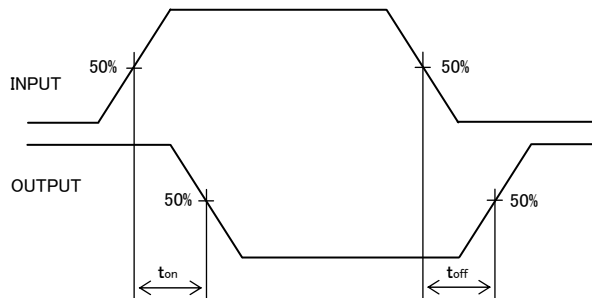

TYPICAL CHARACTERISTICS

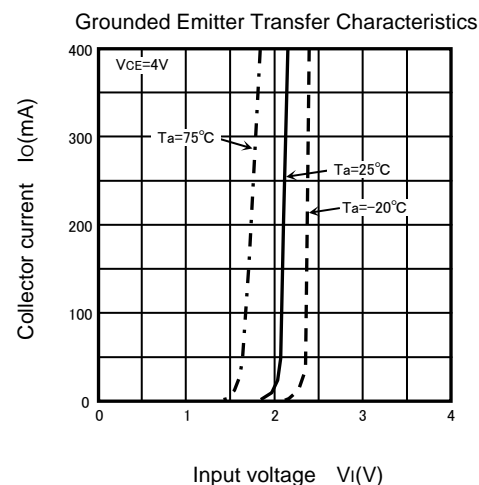
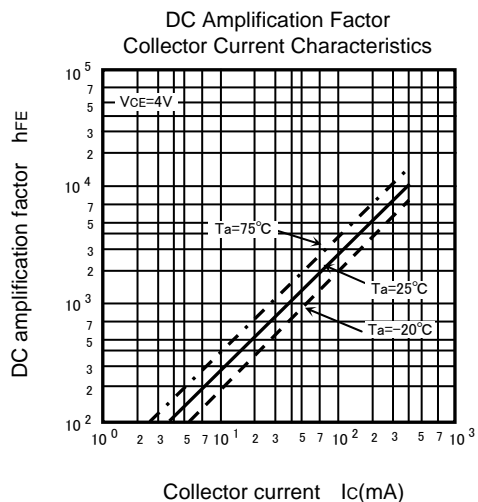
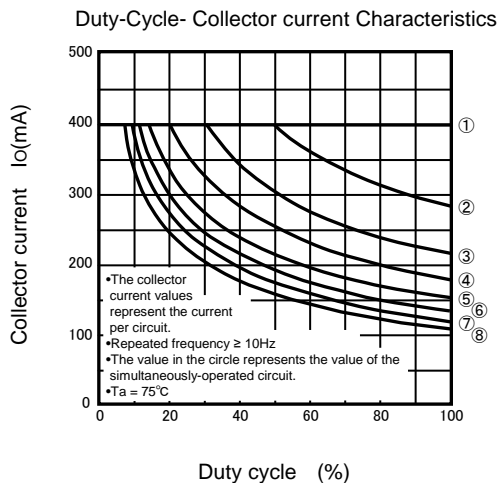
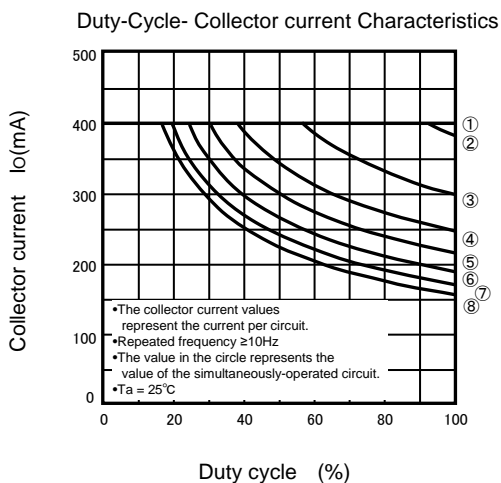
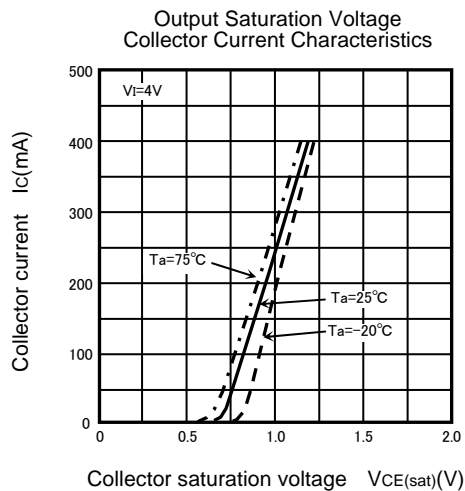
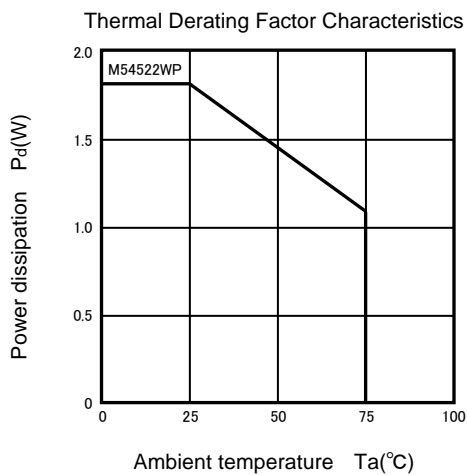

8-UNIT 400mA DARLINGTON TRANSISTOR ARRAY WITH CLAMP DIODE

Input Characteristics

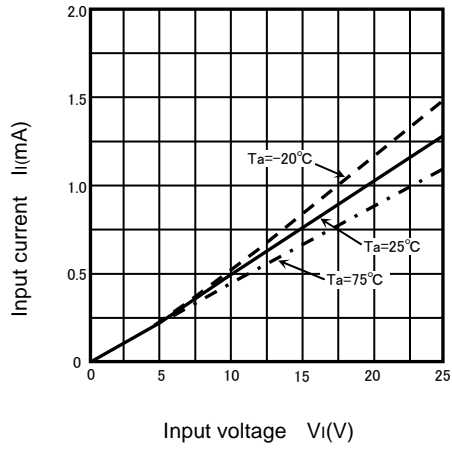

Clamping Diode Characteristics

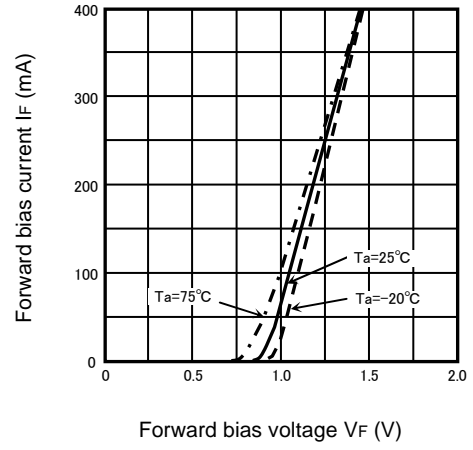

PACKAGE OUTLINE

18P4X

Plastic 18pin 300mil DIP

