

SPECIFICATION

Device Name : IGBT-IPM

Type Name : 6MBP100NA060-01

Spec. No. : MS6M0277

This material and the information herein is the property of Fuji Electric Co.,Ltd. They shall be neither reproduced, copied, lent, or disclosed in any way whatsoever for the use of any third party, nor used for the manufacturing purposes without the express written consent of Fuji Electric Co.,Ltd.

Fuji Electric Co.,Ltd.
Matsumoto Factory

	DATE	NAME	APPROVED	Fuji Electric Co.,Ltd.		
DRAWN	Mar. 27 '96	H. Kawakami	T. HOSEN	DWG. NO.	MS6M0277	1 / 15
CHECKED	" "	N. Terasawa				

Revised Records

Date	Classi- fication	Ind.	Content	Applied date	Drawn	Checked	Approved
Mar. -27-'96	enactment	—	—————	Issued date	—————	N. Terasawa	J. HOSEN

This material and the information herein is the property of
 Fuji Electric Co., Ltd. They shall be neither reproduced, copied,
 lent, or disclosed in any way whatsoever for the use of any
 third party, nor used for the manufacturing purposes without
 the express written consent of Fuji Electric Co., Ltd.

1. Outline Drawing

外形図

Unit : mm

単位 : mm

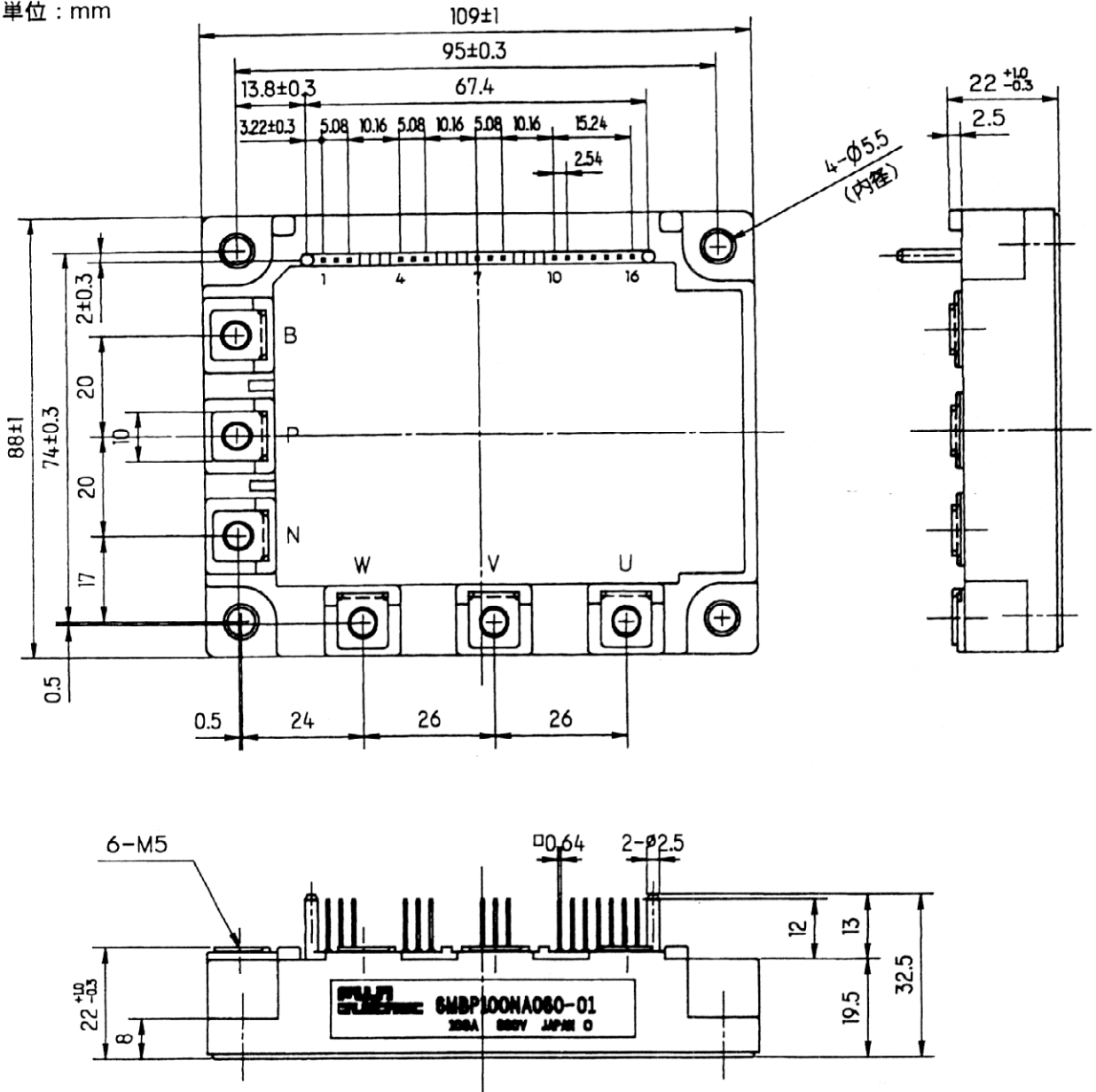

This material and the information herein is the property of Fuji Electric Co., Ltd. They shall be neither reproduced, copied, lent, or disclosed in any way whatsoever for the use of any third party, nor used for the manufacturing purposes without the express written consent of Fuji Electric Co., Ltd.

2 Block Diagram

ブロック図

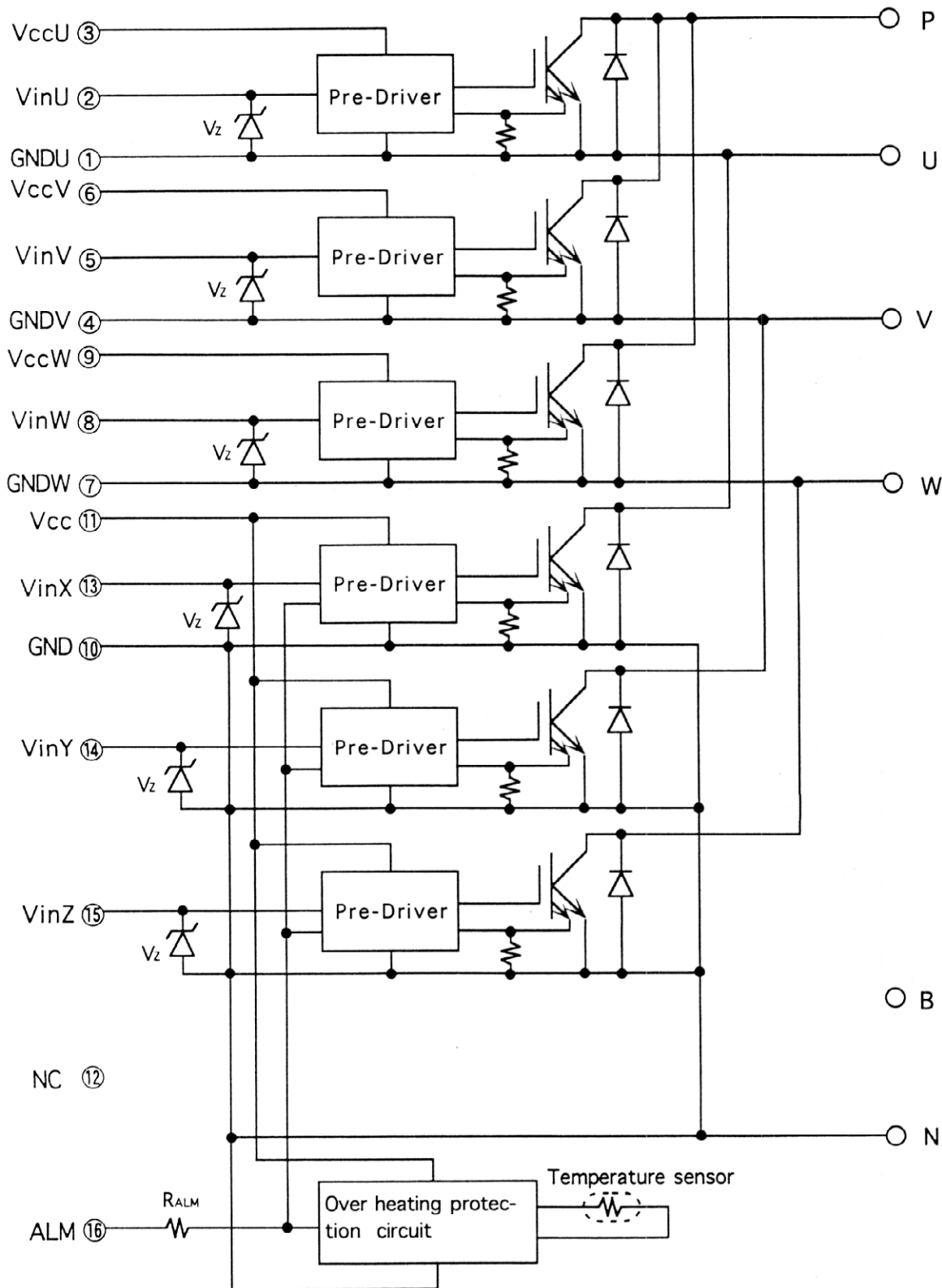

Pre-Drivers include following functions

- ① Short Circuit Protection Circuit
- ② Amplifier for Driver
- ③ Under Voltage Lockout Circuit
- ④ Over current Protection Circuit

This material and the information herein is the property of Fuji Electric Co., Ltd. They shall be neither reproduced, copied, lent, or disclosed in any way whatsoever for the use of any third party nor used for the manufacturing purposes without the express written consent of Fuji Electric Co., Ltd.

3. Absolute Maximum Ratings (at Tc=25°C unless otherwise specified)

Items		Symbols	Ratings		Units	
			Min.	Max.		
DC Bus Voltage		V _{DC}	0	450	V	
DC Bus Voltage (surge)		V _{DC(SURGE)}	0	500	V	
DC Bus Voltage (short operating)		V _{SC}	200	400	V	
Collector-Emitter Voltage		V _{CES}	0	600	V	
I N V	Collector Current	DC	I _c	—	100	A
		1mS	I _{cp}	—	200	A
		Duty=42.0%	-I _c	—	100	A
Collector Power Dissipation One Transistor		P _c	—	400	W	
Junction Temperature		T _j		150	°C	
Input Voltage of Power Supply for Pre-Driver		V _{CC} ※1	0	20	V	
Input Signal Voltage		V _{in} ※2	0	V _Z	V	
Input Signal Current		I _{in}	—	1	mA	
Alarm Signal Voltage		V _{ALM} ※3	0	V _{CC}	V	
Alarm Signal Current		I _{ALM} ※4	—	15	mA	
Storage Temperature		T _{stg}	-40	125	°C	
Operating Case Temperature (Fig.1)		T _{OP}	-20	100	°C	
Isolation Voltage (Case-Terminal)		V _{iso} ※5	—	AC2.5	kV	

- Note ※ 1 V_{CC} shall be applied to the input Voltage between terminal No. 3 and 1 , 6 and 4, 9 and 7, 11 and 10.
 ※ 2 V_{in} shall be applied to the input Voltage between terminal No. 2 and 1 , 5 and 4, 8 and 7, 12 13 14 15 and 10.
 ※ 3 V_{ALM} shall be applied to the Voltage between terminal No. 16 and 10.
 ※ 4 I_{ALM} shall be applied to the input current to terminal No. 16.
 ※ 5 50Hz/60Hz sine wave 1 minute.

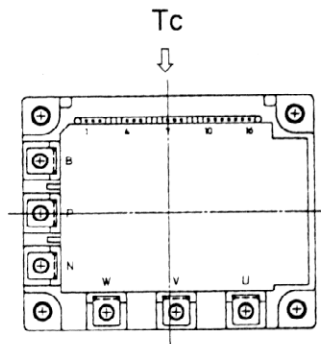

Fig.1 Measurement of case temperature

This material and the information herein is the property of Fuji Electric Co.,Ltd. They shall be neither reproduced, copied, lent, or disclosed in any way whatsoever for the use of any third party, nor used for the manufacturing purposes without the express written consent of Fuji Electric Co.,Ltd.

4. Electrical Characteristics

4.1 Electrical Characteristics of Power Circuit (at $T_c=T_j=25^\circ\text{C}$, $V_{cc}=15\text{V}$)

Items		Symbols	Conditions	Min.	Typ.	Max.	Units
I N V	Collector Current at off Signal Input	I_{CES}	$V_{CE}=600\text{V}$	—	—	1.0	mA
	Collector-Emitter Saturation Voltage	$V_{CE(sat)}$	$I_c=100\text{A}$	—	—	2.9	V
Forward Voltage of FWD		V_F	$-I_c=100\text{A}$	—	—	3.3	V

4.2 Electrical Characteristics of Control Circuit (at $T_c=T_j=25^\circ\text{C}$, $V_{cc}=15\text{V}$)

Items		Symbols	Conditions	Min.	Typ.	Max.	Units
Power Supply Current of P-Line Side Pre-Driver (One Unit)		I_{CCP}	$f_{sw}=15\text{kHz} \times 6$ Duty=50%	—	8	18	mA
Power Supply Current of N-Line Side Three Pre-Drivers and Protection Circuits		I_{CCN}	$f_{sw}=15\text{kHz}$ Duty=50%	—	24	54	mA
Input signal Threshold Voltage		$V_{in(ON)}$	ON	1.00	1.35	1.70	V
		$V_{in(OFF)}$	OFF	1.25	1.60	1.95	
Zener Voltage		V_Z		6.9	—	7.7	V
Over Heating Protection(OH) Level		T_{OH}	$V_{DC}=0\text{V}, I_c=0\text{A}$ Case Temperature	100	—	125	$^\circ\text{C}$
OH Hysteresis		T_H		—	20	—	$^\circ\text{C}$
Over Current Protection(OC) Level	INV	I_{oc}	$T_j=125^\circ\text{C}$ Collector Current	130	—	—	A
OC Delay Time (Fig.2)		t_{DOC}	$T_j=25^\circ\text{C}$	—	8	—	μS
Under Voltage Protection(UV) Level		V_{UVT}		11.0	12.0	12.5	V
UV Hysteresis		V_H		0.2	—	—	V
Alarm Signal Hold Time		t_{ALM}		0.8	2	—	mS
Delay Time of Short Circuit Protection (Fig.3)		t_{SC}		12	—	—	μS
Limiting Resistor for Alarm		R_{ALM}		1425	1500	1575	Ω

※6 Switching frequency of IPM

4.3 Dynamic Characteristics (at $T_c=T_j=125^\circ\text{C}$, $V_{cc}=15\text{V}$)

Items		Symbols	Conditions	Min.	Typ.	Max.	Units
Switching Time Fig.4	t_{on}	$I_c=100\text{A}$	$V_{bc}=300\text{V}$	0.3	—	—	μS
	t_{off}			—	—	3.6	μS
Switching Time (FWD)		t_{rr}	$I_F=100\text{A}, V_{DC}=300\text{V}$	—	—	400	nS

Fuji Electric Co.,Ltd.

DWG.NO.

MS6M0277

6 / 15

H04-004-03

This material and the information herein is the property of Fuji Electric Co.,Ltd. They shall be neither reproduced, copied, lent, or disclosed in any way whatsoever for the use of any third party, nor used for the manufacturing purposes without the express written consent of Fuji Electric Co.,Ltd.

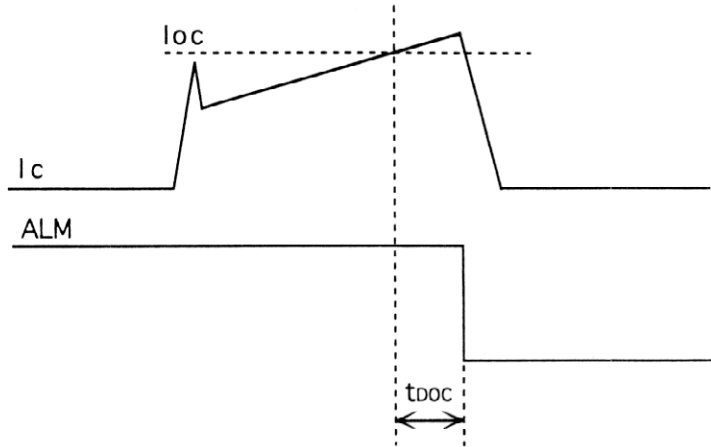

Fig.2 : Definition of OC Delay Time

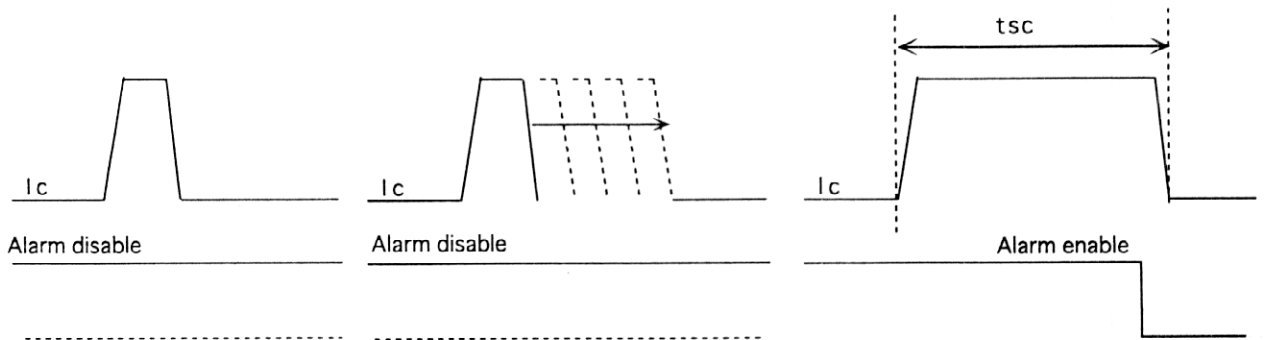

Fig.3 : Definition of tsc

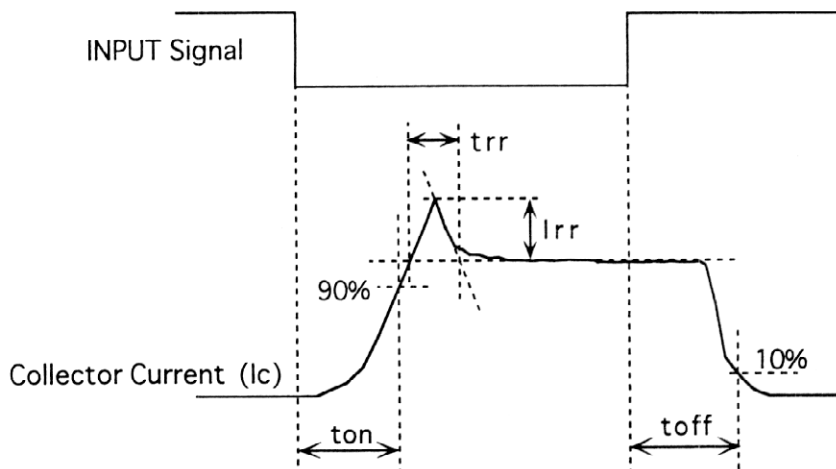

Fig.4 : Definition of switching time

5. Thermal Characteristics (Tc=25°C)

Items			Symbols	Min.	Typ.	Max.	Units
Junction to Case Thermal Resistance	INV	IGBT	Rth(j-c)	—	—	0.31	°C/W
		FWD	Rth(j-c)	—	—	0.90	°C/W
Case to Fin Thermal Resistance with Compound			Rth(c-f)	—	0.05	—	°C/W

6. Mechanical Characteristics

Items		Min.	Typ.	Max.	Units
Screw Torque	Mounting (M5)	—	—	3.5	N·m
	Terminal (M5)	—	—	3.5	N·m
Weight		—	550	—	g

7. Recommendable Value

Items		Symbols	Conditions	Min.	Typ.	Max.	Units
DC Bus Voltage		V _{dc}		200	—	400	V
Operating Power Supply Voltage Range of Pre-Driver		V _{cc}		13.5	15	16.5	V
Switching frequency of IPM		f _{sw}		1	—	20	kHz
Screw Torque	Mounting (M5)	—		2.5	—	3.5	N·m
	Terminal (M5)	—		2.5	—	3.5	N·m

This material and the information herein is the property of
 Fuji Electric Co., Ltd. They shall be neither reproduced, copied,
 lent, or disclosed in any way whatsoever for the use of any
 third party nor used for the manufacturing purposes without
 the express written consent of Fuji Electric Co., Ltd.

8. Packing and labeling

梱包箱と表示

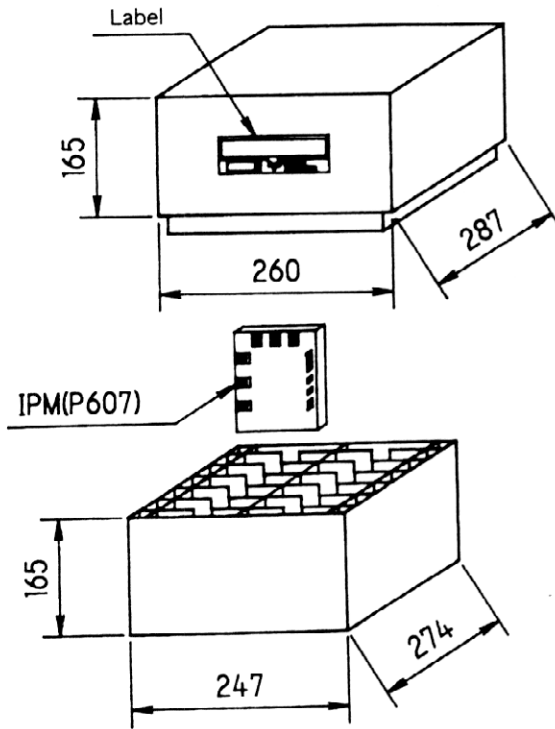

material card board
 weight 5.5 kg (Max.)
 products 10pcs (Max.)

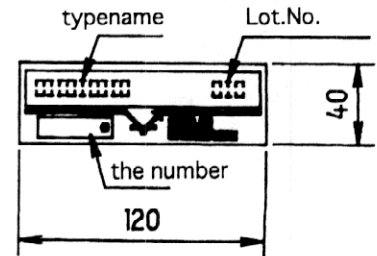

9. Storage and transportation notes (保管、運搬上の注意事項)

- ・ The IGBT-IPM should be stored at a standard temperature of 5 to 35 °C and humidity of 45 to 75%.
 常温保存が望ましい。(5~35℃、45~75%)
- ・ Store modules in a place with few temperature changes in order to avoid condensation on the module surface.
 急激な温度変化の無きこと。(モジュール表面が結露しないこと)
- ・ Avoid exposure to corrosive gases and dust.
 腐食性ガスの発生場所、塵埃の多い場所は避けること。
- ・ Avoid excessive external force on the module.
 製品に荷重がかからないように十分に注意すること。
- ・ Store modules with unprocessed terminals.
 モジュールの端子は未加工の状態での保管すること。
- ・ Do not drop or otherwise shock the modules when transporting.
 製品の運搬時に衝撃を与えたり、落下させたりしないこと。

10. Applicable category (適用範囲)

This specification is applied to IGBT-IPM named 6MBP100NA060-01.

本納入仕様書は、IGBT-IPM 6MBP100NA060-01 に適用する。

11. Characteristic (Representative)

特性カーブ (代表例)

11-1. Control Circuit

制御部

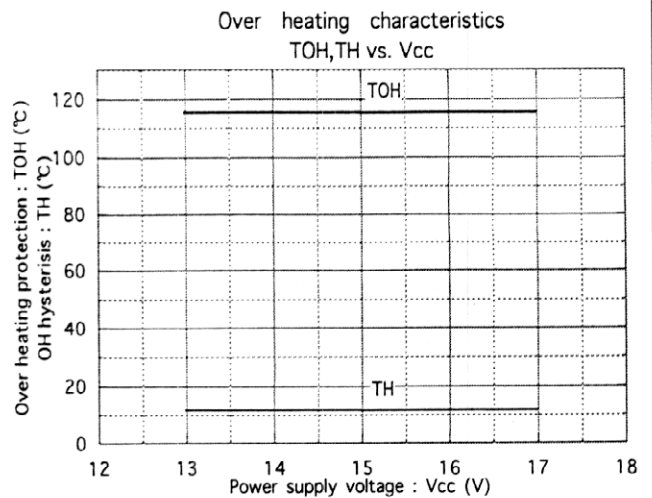
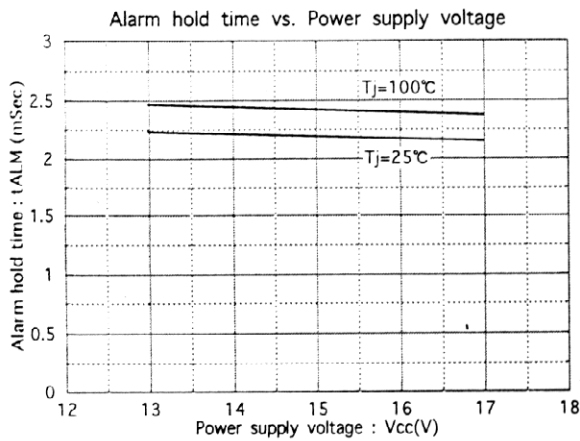
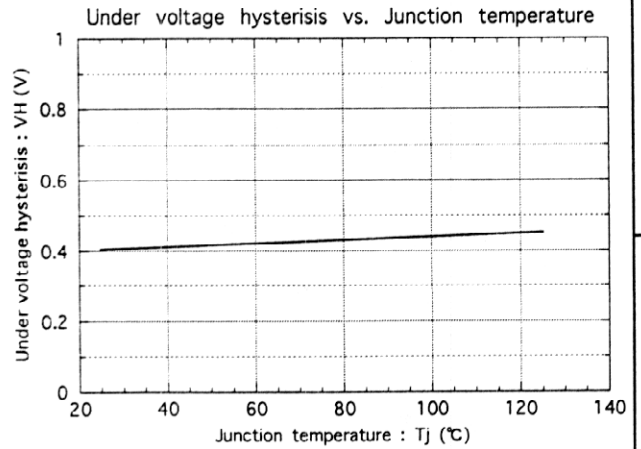
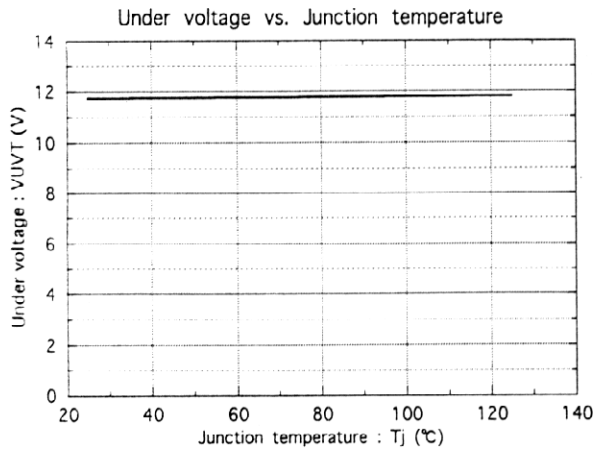
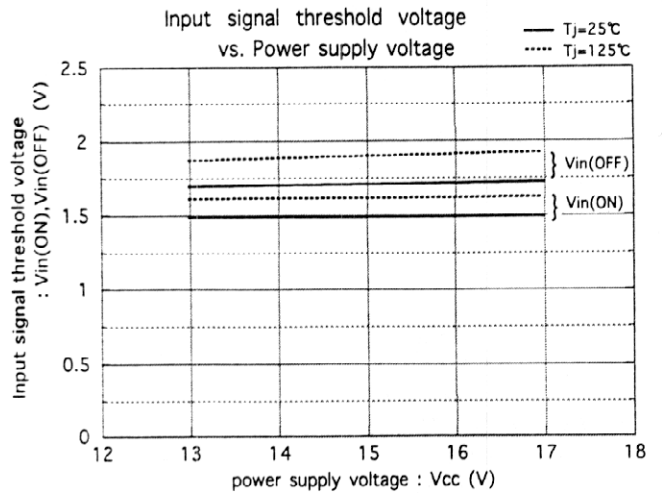
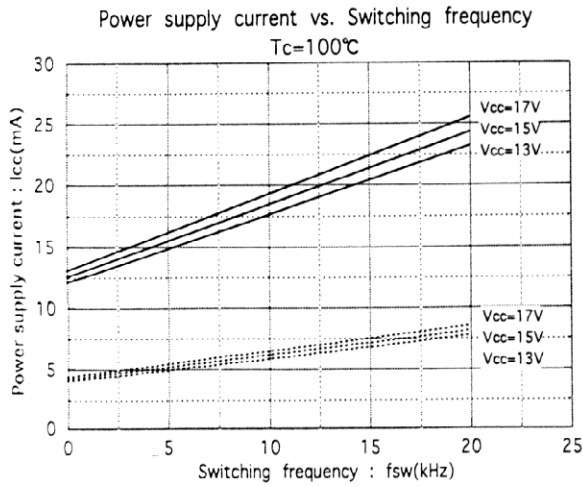

This material and the information herein is the property of Fuji Electric Co., Ltd. They shall be neither reproduced, copied, lent, or disclosed in any way whatsoever for the use of any third party, nor used for the manufacturing purposes without the express written consent of Fuji Electric Co., Ltd.

11-2. Inverter

インバータ部

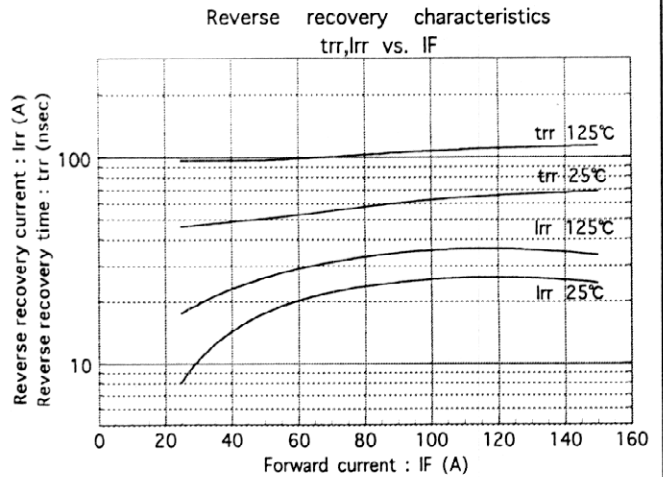
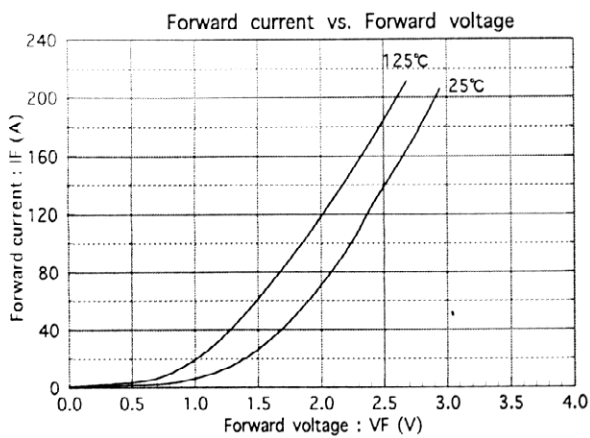
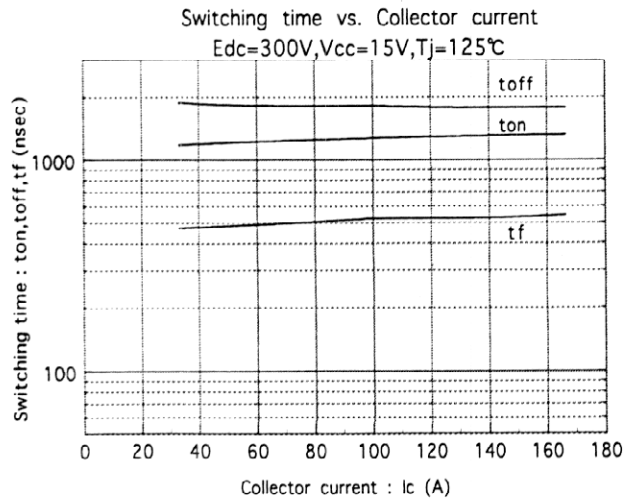
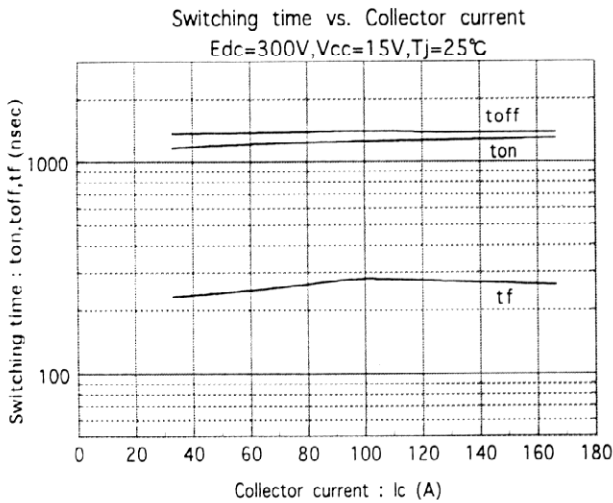
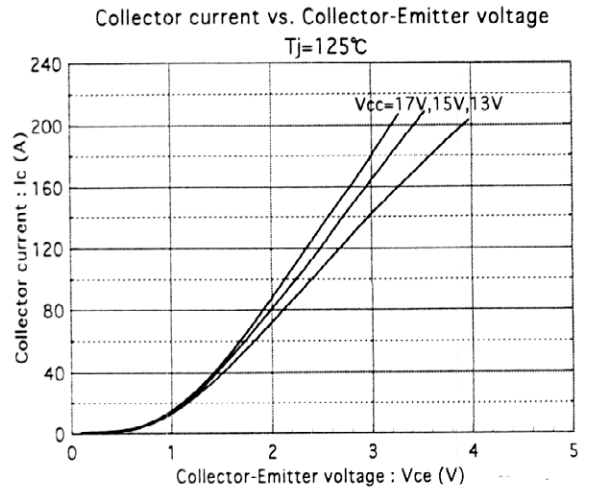
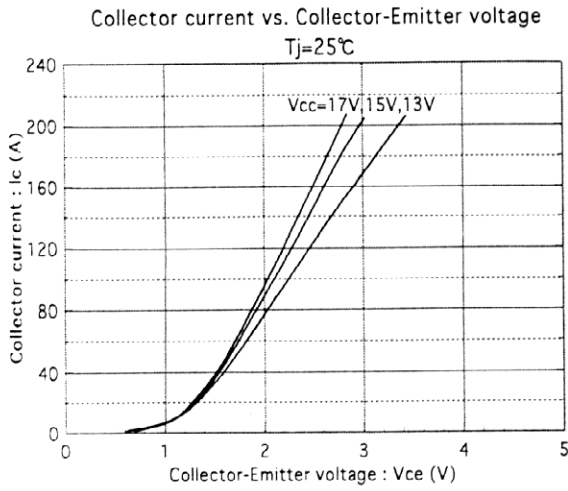

This material and the information herein is the property of Fuji Electric Co., Ltd. They shall be neither reproduced, copied, lent, or disclosed in any way whatsoever for the use of any third party, nor used for the manufacturing purposes without the express written consent of Fuji Electric Co., Ltd.

This material and the information herein is the property of Fuji Electric Co., Ltd. They shall be neither reproduced, copied, lent, or disclosed in any way whatsoever for the use of any third party, nor used for the manufacturing purposes without the express written consent of Fuji Electric Co., Ltd.

Transient thermal resistance

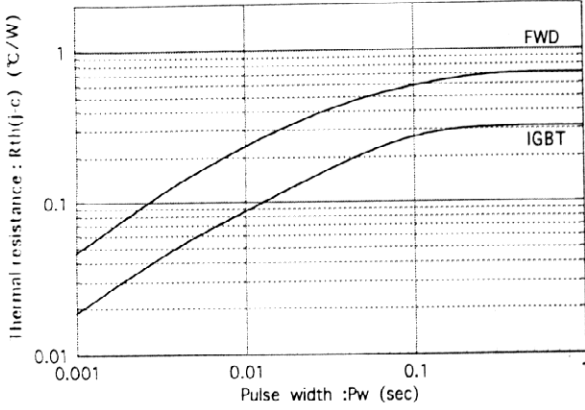

Reversed biased safe operating area
 $V_{cc}=15V, T_j \leq 125^\circ C$

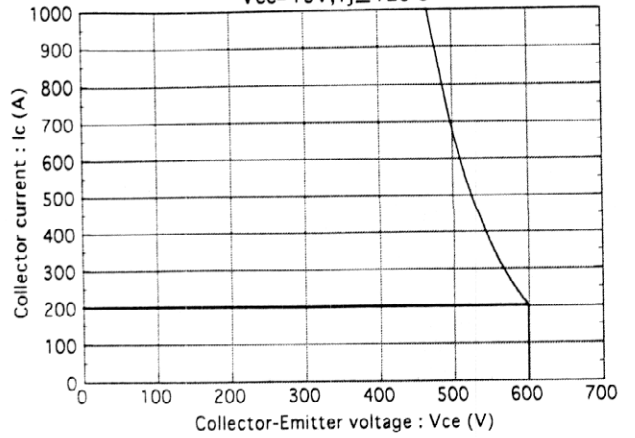

Power derating for IGBT
(per device)

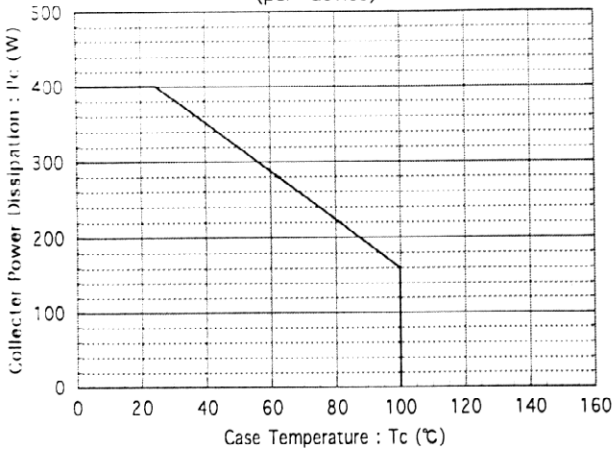

Power derating for FWD
(per device)

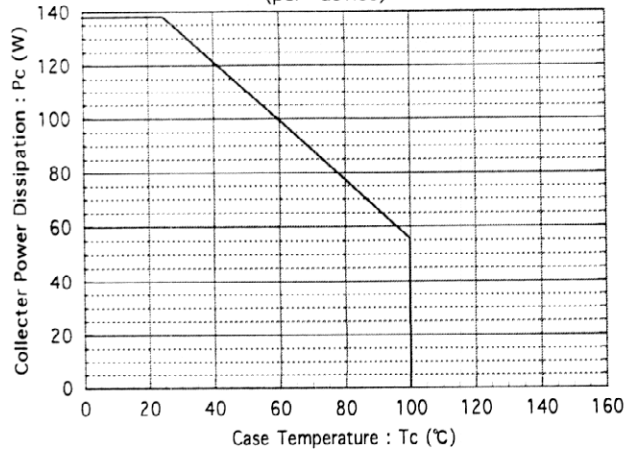

Switching Loss vs. Collector Current
 $E_{dc}=300V, V_{cc}=15V, T_j=25^\circ C$

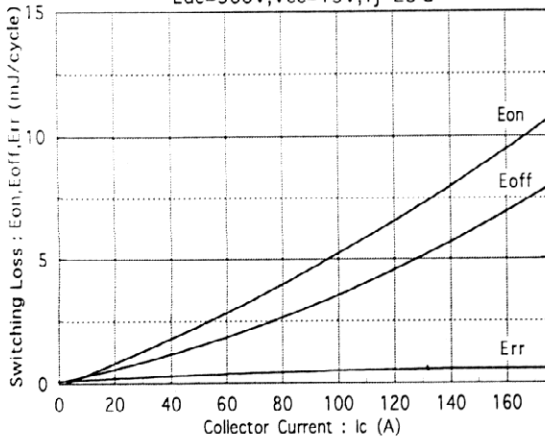

Switching Loss vs. Collector Current
 $E_{dc}=300V, V_{cc}=15V, T_j=125^\circ C$

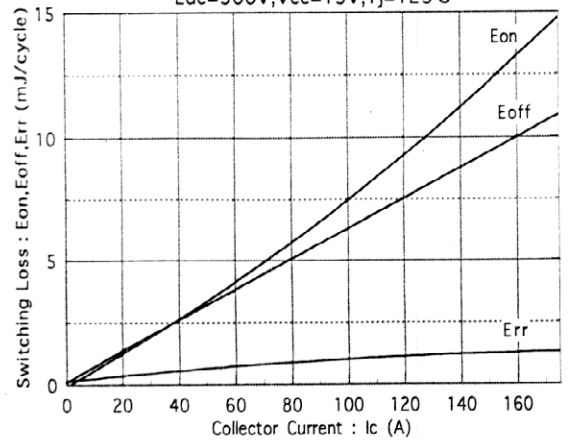

This material and the information herein is the property of Fuji Electric Co., Ltd. They shall be neither reproduced, copied, lent, or disclosed in any way whatsoever for the use of any third party, nor used for the manufacturing purposes without the express written consent of Fuji Electric Co., Ltd.

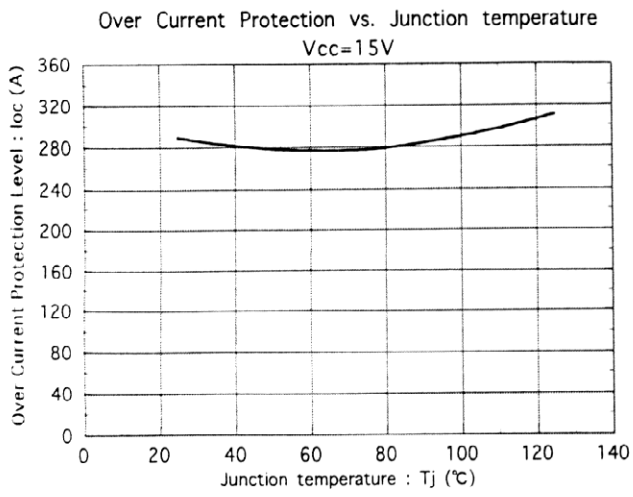

Fuji Electric Co.,Ltd.

DWG.NO.

MS6M0277

13/15

H04-004-03

12.Example of applied circuit (応用回路例)

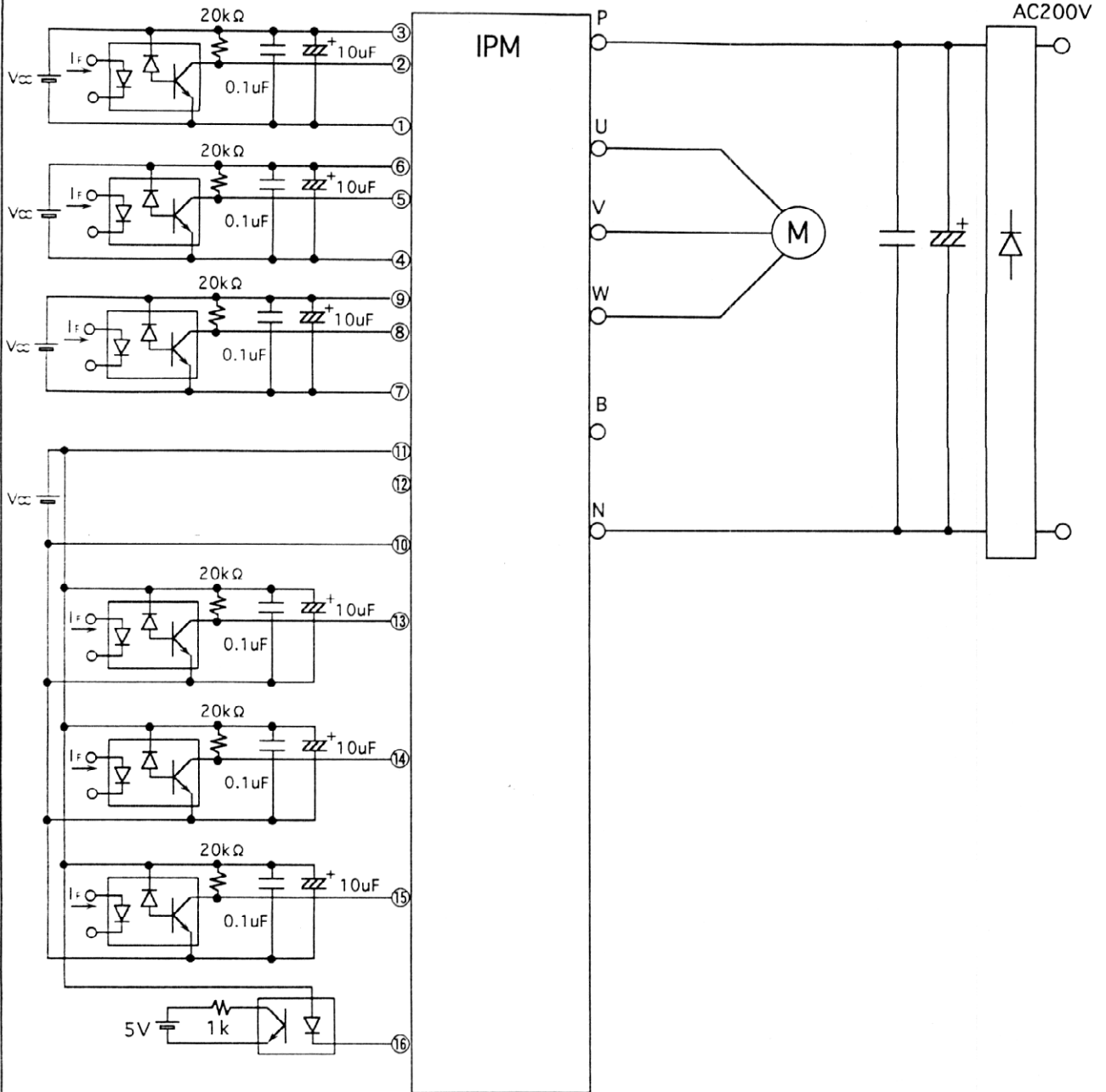

- The wiring between opto-coupler and input terminal of IPM should be shorter as much as possible. The stray-capacitance between primary and secondary side of opto-coupler should not be increased by pattern lay-out.
 ホトカブラとIPMの入力端子間配線は、できるだけ短くしホトカブラの1次・2次間の浮遊容量を増加させないパターンレイアウトとして下さい。
- Capacitor should be installed to VCC-GND terminal of high-speed opto-coupler closely as much as possible.
 高速ホトカブラのVcc-GND間には、コンデンサをできるだけ近接して取り付けして下さい。
- Use high-speed opto-coupler : $t_{PLH}, t_{PHL} \leq 0.8\mu s$, high CMR type. (Example : HCPL-4504)
 高速ホトカブラ : $t_{PLH}, t_{PHL} \leq 0.8\mu s$, 高CMRタイプをご使用下さい。(例 HPCL-4504)
- Low-speed opto-coupler : $CTR \geq 100\%$
 低速ホトカブラ : $CTR \geq 100\%$

This material and the information herein is the property of Fuji Electric Co., Ltd. They shall be neither reproduced, copied, lent, or disclosed in any way whatsoever for the use of any third party nor used for the manufacturing purposes without the express written consent of Fuji Electric Co., Ltd.

- Each power supply for drive circuit should not have transient voltage fluctuation. Four power supplies which are isolated should be supplied individually.
各制御用電源は瞬時電圧変動の少ない、絶縁したものを4個独立にして供給して下さい。
- The DC bus line to the P-N terminal should have lower inductance as much as possible, such as connecting capacitor to P-N terminal, in order to reduce surge voltage.
P-N間の直流母線はできるだけ低インダクタンス化し、P-N端子間にコンデンサを接続するなどしてサージ電圧を低減して下さい。
- In order to avoid noise from AC line, connect capacitor (about 4.7uF) between three-phase line and earth.
ACラインからのノイズ侵入を防ぐため、三相各線-大地間に4.7nF程度のコンデンサを接続して下さい。
- Do not connect N-terminal of main circuit to ground (GND) of input circuit.
入力回路のグラウンド (GND) と主回路 N 端子を IPM の外側で接続しないで下さい。
- In case of using connector for connection to control terminal, it must be Au-plated electrode and 2.54mm of pitch.
制御端子との接続にコネクタを用いる場合は、金メッキ電極・2.54mm ピッチのものをご使用下さい。
- When capacitor is connected between input and GND terminal, pay attention to longer delay time after signal inputted to primary side of opto-coupler.
入力端子-GND間にコンデンサを接続するとホトカプラ1次側入力信号に対する応答時間が長くなりますのでご注意下さい。