

IGBT MODULE (L series)

■ Features

- High Speed Switching
- Low Saturation Voltage
- Voltage Drive

■ Applications

- Inverter for Motor Drive
- AC and DC Servo Drive Amplifier
- Uninterruptible Power Supply
- Industrial Machines, such as Welding Machines

■ Maximum Ratings and Characteristics

● Absolute Maximum Ratings

Items	Symbols	Ratings	Units
Collector-Emitter Voltage	V _{CES}	1200	V
Gate-Emitter Voltage	V _{GES}	±20	V
Collector Current	Continuous	I _C	300
	1ms	I _{C pulse}	600
	Continuous	-I _C	300
	1ms	-I _{C pulse}	600
Max. Power Dissipation	P _C	2000	W
Operating Temperature	T _j	+150	°C
Storage Temperature	T _{stg}	-40 to +125	°C
Net. Weight		415	g
Isolation Voltage	AC. 1min.	V _{isol}	2500
Screw Torque	Mounting *1	35	kg•cm
	Terminals *2	45	
	Terminals *3	17	

● Electrical Characteristics (T_c=25°C)

Items	Symbols	Test Conditions	Min.	Typ.	Max.	Units
Zero Gate Voltage Collector Current	I _{CES}	V _{GE} =0V V _C E=1200V T _c =25°C			4.0	mA
		V _{GE} =0V V _C E=1200V T _c =125°C			—	mA
Gate-Emitter Leakage Current	I _{GES}	V _C E=0V V _{GE} =±20V			400	nA
Gate-Emitter Threshold Voltage	V _{GE(th)}	V _C E=20V I _C =300mA	3.0		6.0	V
Collector-Emitter Saturation Voltage	V _{CE(sat)}	V _{GE} =15V I _C =300A			3.5	V
Input Capacitance	C _{ies}	V _{GE} =0V		54000		pF
Output Capacitance	C _{oes}	V _C E=10V		—		
Reverse Transfer Capacitance	C _{res}	f=1MHz		—		
Turn-on Time	t _{on}	V _{CC} =600V		0.6	0.8	μs
	t _r	I _C =300A		0.4	0.6	
Turn-off Time	t _{off}	V _{GE} =±15V		0.8	1.5	
	t _f	R _G =2.7Ω		0.3	0.5	
Diode Forward On-Voltage	V _F	I _F =300A V _{GE} =0V			2.5	V
Reverse Recovery Time	t _{rr}	I _F =300A -di/dt=900A/μs V _{GE} =-10V		200	350	ns

● Thermal Characteristics

Items	Symbols	Test Conditions	Min.	Typ.	Max.	Units
Thermal Resistance	R _{th(j-c)}	IGBT			0.063	°C/W
	R _{th(j-e)}	Diode			0.10	
	R _{th(c-f)}	With Thermal compound		0.0125		

■ Outline Drawings

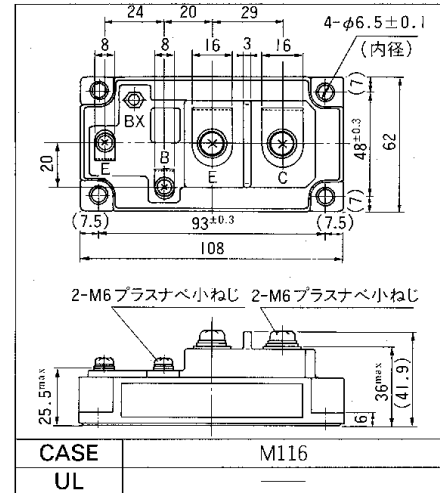

■ Equilavent Circuit Schematic

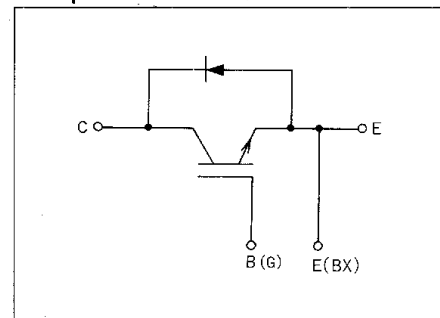

*1 Recommendable Value 25 to 35kg•cm (M5)

*2 Recommendable Value 35 to 45kg•cm (M6)

*3 Recommendable Value 13 to 17kg•cm (M4)

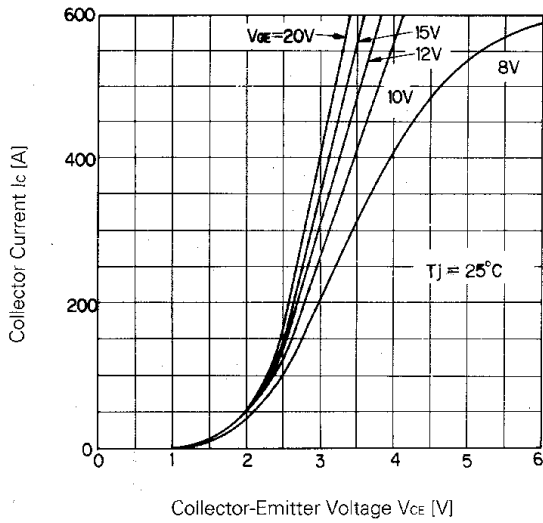

Collector Current vs. Collector-Emitter Voltage

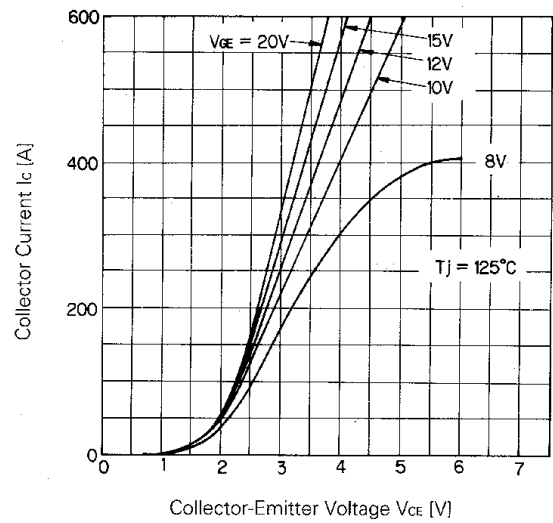

Collector Current vs. Collector-Emitter Voltage

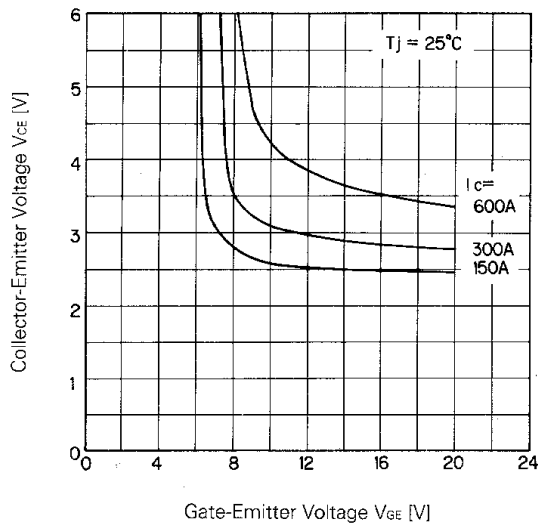

Collector-Emitter Voltage vs. Gate-Emitter Voltage

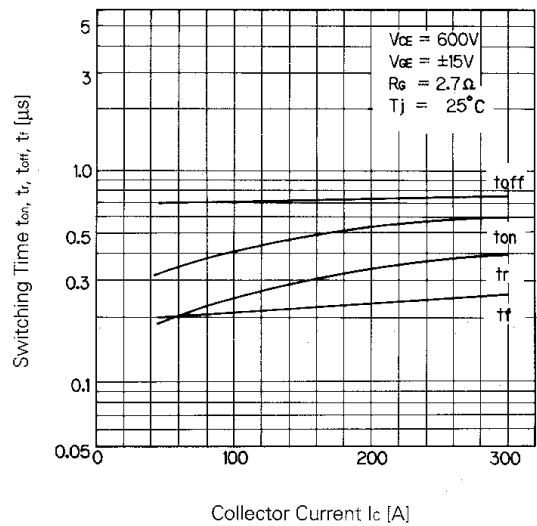

Switching Time

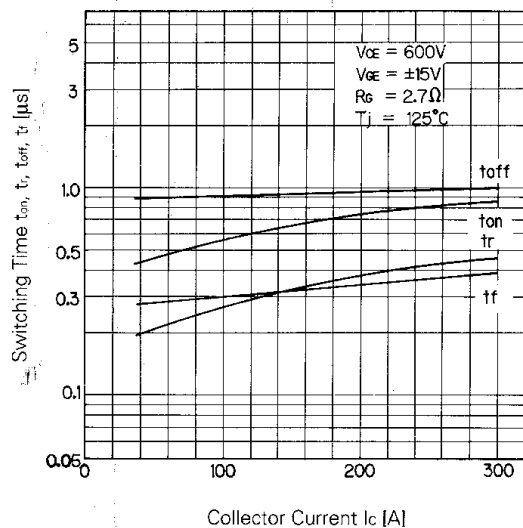

Switching Time

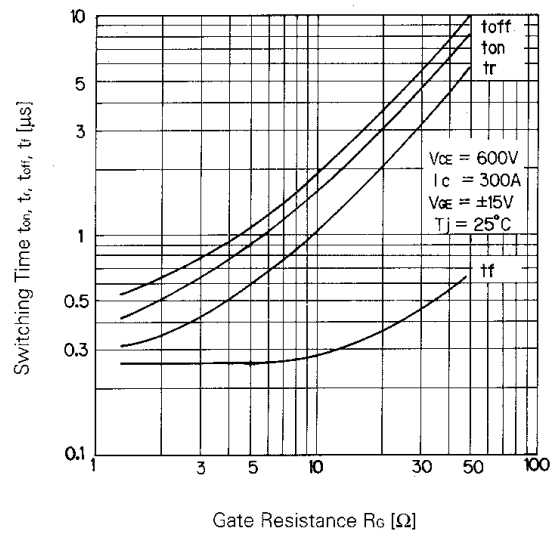

Switching Time-Gate Resistance

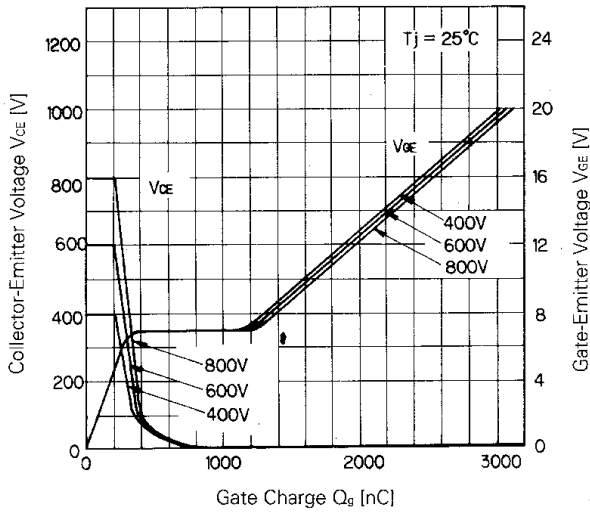

Dynamic Input Characteristic

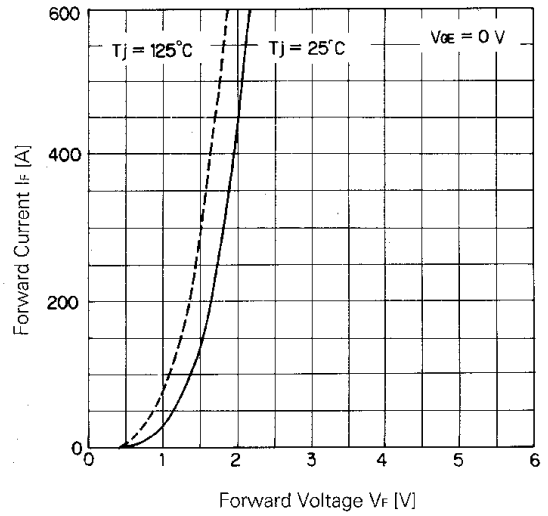

Forward Voltage of Free Wheel Diode

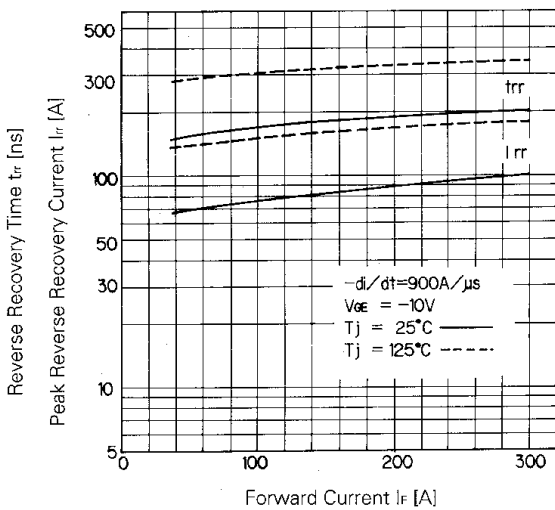

t_{rr} , I_{rr} - I_f

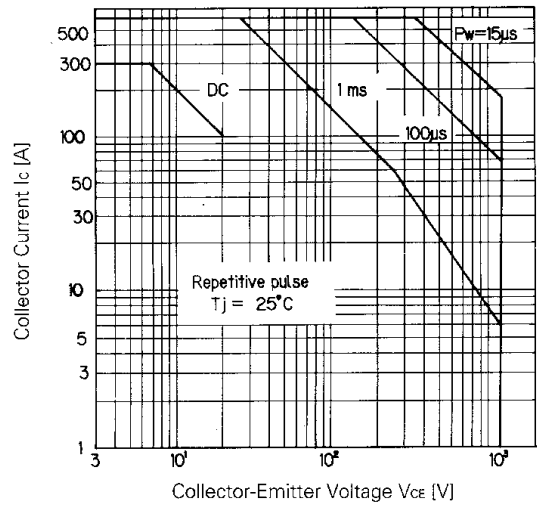

Safe Operating Area

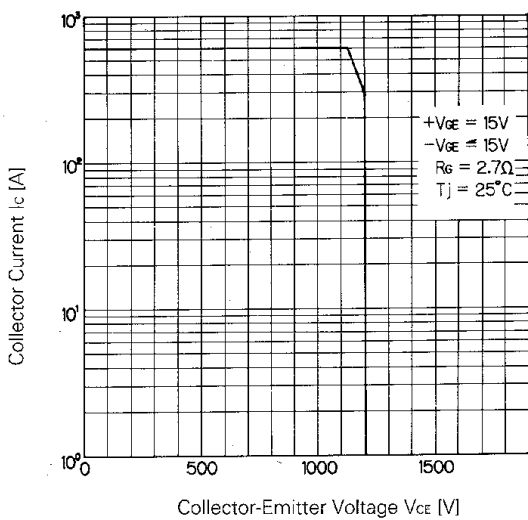

Reverse Biased Safe Operating Area

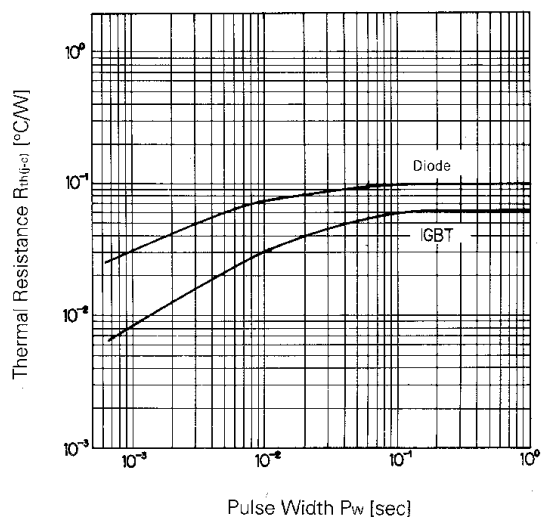

Transient Thermal Resistance

For more information, contact:

Collmer Semiconductor, Inc.

P.O. Box 702708

Dallas, TX 75370

972-733-1700

972-381-9991 Fax

<http://www.collmer.com>