



Product Description

Sirenza Microdevices' SZM-3066Z is a high linearity class AB Heterojunction Bipolar Transistor (HBT) amplifier housed in a low-cost surface-mountable plastic Q-FlexN multi-chip module package. This HBT amplifier is made with InGaP on GaAs device technology and fabricated with MOCVD for an ideal combination of low cost and high reliability.

This product is specifically designed as a final or driver stage for 802.16 equipment in the 3.3-3.8 GHz bands. It can run from a 3V to 6V supply. The external output match and bias adjustability allows load line optimization for other applications or over narrower bands. It features an output power detector, on/off power control and high RF overdrive robustness. This product features a RoHS compliant and Green package with matte tin finish, designated by the 'Z' suffix.

Functional Block Diagram

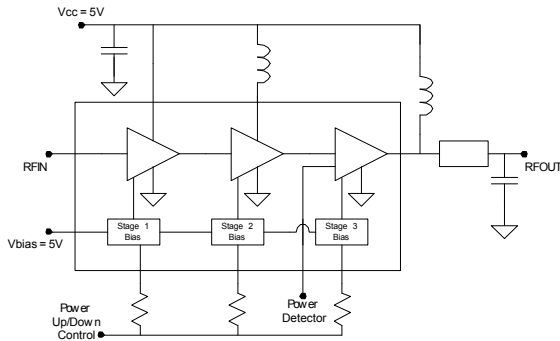

Key Specifications

Symbol	Parameters: Test Conditions, 3.3-3.8GHz App circuit, $Z_0 = 50\Omega$, $V_{CC} = 5.0V$, $I_q = 600mA$, $T_{BP} = 30^\circ C$	Unit	Min.	Typ.	Max.
f_O	Frequency of Operation	MHz	3300		3800
P_{1dB}	Output Power at 1dB Compression – 3.5GHz	dBm		33.5	
S_{21}	Small Signal Gain @ $P_{out} = 26dBm$ – 3.5GHz	dB	32.5	34	
P_{out}	Output power at 2.5% EVM 802.11g 54Mb/s - 3.5GHz	dBm		26	
IM3	Third Order Suppression ($P_{out}=23dBm$ per tone) - 3.5GHz	dBc		-38	-33
NF	Noise Figure at 3.6 GHz	dB		5	
IRL	Worst Case Input Return Loss 3.3-3.8GHz	dB	9	14	
ORL	Worst Case Output Return Loss 3.3-3.8GHz		6	9	
Vcc	Supply voltage range	V	3	5	6
Vdet Range	Output Voltage Range for $P_{out}=10dBm$ to 33dBm	V		0.9 to 2.2	
I_{cq}	Quiescent Current ($V_{cc} = 5V$)	mA	520	600	680
I_{VPC}	Power Up Control Current ($V_{pc}=5V$) ($I_{VPC1} + I_{VPC2} + I_{VPC3}$)	mA		5	
I_{leak}	Vcc Leakage Current ($V_{cc} = 5V$, $V_{pc} = 0V$)	mA			0.1
$R_{th, j-l}$	Thermal Resistance (junction - lead)	$^\circ C/W$		10	

The information provided herein is believed to be reliable at press time. Sirenza Microdevices assumes no responsibility for inaccuracies or omissions. Sirenza Microdevices assumes no responsibility for the use of this information, and all such information shall be entirely at the user's own risk. Prices and specifications are subject to change without notice. No patent rights or licenses to any of the circuits described herein are implied or granted to any third party. Sirenza Microdevices does not authorize or warrant any Sirenza Microdevices product for use in life-support devices and/or systems.

Copyright 2002 Sirenza Microdevices, Inc. All worldwide rights reserved.
303 South Technology Court Broomfield, CO 80021

Phone: (800) SMI-MMIC

<http://www.sirenza.com>
EDS-104608 Rev C

Preliminary

SZM-3066Z

3.3-3.8GHz 2W Power Amplifier

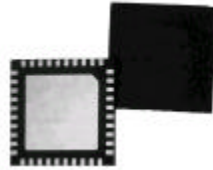

RoHS Compliant & Green Package

6mm x 6mm QFN Package

Product Features

- $P_{1dB} = 33.5dBm$ @ 5V
- Three Stages of Gain: 34dB
- 802.11g 54Mb/s Class AB Performance
 $P_{out} = 26dBm$ @ 2.5% EVM, $V_{cc} 5V, 730mA$
- Active Bias with Adjustable Current
- On-chip Output Power Detector
- Low Thermal Resistance
- Power up/down control < 1 μs
- Class 1C ESD Rating

Applications

- 802.16 WiMAX Driver or Output Stage
- Fixed Wireless, WLL

Typical Performance 3.3-3.8GHz App Circuit (Vcc=5V, Icq=600mA, * 802.11g 54Mb/s 64QAM)

Parameter	Units	3.3GHz	3.4GHz	3.5GHz	3.6GHz	3.7GHz	3.8GHz
Gain @ Pout=26dBm	dB	35.2	35.2	35.2	34.5	32.8	30.0
P1dB	dBm	34.4	34.3	34.3	34.1	33.9	33.0
Pout @ 2.5% EVM*	dBm	26.5	26.5	26.5	26.5	26	26
Current @ Pout 2.5% EVM*	mA	769	769	752	750	750	720
Input Return Loss	dB	15	17	19	21	19	16
Output Return Loss	dB	10	10.5	10	9	9	8

Absolute Maximum Ratings

Parameters	Value	Unit
VC3 Collector Bias Current (I _{VC3})	1500	mA
VC2 Collector Bias Current (I _{VC2})	600	mA
VC1 Collector Bias Current (I _{VC1})	300	mA
**Device Voltage (V _D)	9.0	V
Power Dissipation	6	W
Operating Lead Temperature (T _L)	-40 to +85	°C
*Max RF output Power for 50 ohm continuous long term operation	30	dBm
Max RF Input Power for 50 ohm output load	29	dBm
Max RF Input Power for 10:1 VSWR output load	5	dBm
Storage Temperature Range	-40 to +150	°C
Operating Junction Temperature (T _J)	+150	°C
ESD Human Body Model	1000	V

Operation of this device beyond any one of these limits may cause permanent damage. For reliable continuous operation the device voltage and current must not exceed the maximum operating values specified in the table on page one.

Bias conditions should also satisfy the following expression:
 $I_D V_D < (T_J - T_L) / R_{TH} \text{ } ^\circ\text{C}$

* With specified application circuit.

** No RF Drive



Caution: ESD Sensitive

Appropriate precaution in handling, packaging and testing devices must be observed.



Preliminary
SZM-3066Z 3.3-3.8GHz 2W Power Amp

Pin Out Description

Pin #	Function	Description
5, 7, 11, 12, 17, 18, 22, 29, 31, 33, 34, 39, 40	NC	These are no connect (NC) pins and are not wired inside the package. It is recommended to connect them as shown in the application circuit to achieve the stated performance.
1, 10, 21, 30	GND	These pins are internally grounded inside the package to the backside ground paddle. It is recommended to also ground them external to the package to achieve the specified performance.
2	VC1	This is the collector of the first stage.
3	VBIAS12	This is the supply voltage for the active bias circuit of the 1st and 2nd stages.
4	NC	This pin is not connected inside the package, but it is recommended to connect it to GND to achieve the specified performance.
6	RFIN	This is the RF input pin. It is DC grounded inside the package. Do not apply DC voltage to this pin.
8	VPC1	Power up/down control pin for the 1st stage. An external series resistor is required for proper setting of bias levels depending on control voltage. The voltage on this pin should never exceed the voltage on pin 3 by more than 0.5V unless the supply current from pin 3 is limited < 10mA.
9	VPC2	Power up/down control pin for the 2nd stage. An external series resistor is required for proper setting of bias levels depending on control voltage. The voltage on this pin should never exceed the voltage on pin 3 by more than 0.5V unless the supply current from pin 3 is limited < 10mA.
13, 38	VC2A, VC2B	These two pins are connected internal to the package to the 2nd stage collector. To achieve specified performance, the layout of these pins should match the Recommended Land Pattern, pg. 9.
14, 15, 36, 37	C1A, C2A C1B, C2B	These pins have capacitors across them internal to the package as shown in the below schematic. They are used as tuning and RF coupling elements between the 2nd and 3rd stage.
16, 35	VB3A, VB3B	These are the connections to the base of the 3rd stage output device. To achieve specified performance, the layout of these pins should match the Recommended Land Pattern, pg. 9.
19	VPC3	Power up/down control pin for the 3rd stage. An external series resistor is required for proper setting of bias levels depending on control voltage. The voltage on this pin should never exceed the voltage on pin 32 by more than 0.5V unless the supply current from pin 32 is limited < 10mA.
20	VDET	This is the output port for the power detector. It samples the power at the input of the 3rd stage.
23-28	RFOUT	These are the RF output pins and DC connections to the 3rd stage collector.
32	VBIAS3	This is the supply voltage for the active bias circuit of the 3rd stage.

Simplified Device Schematic

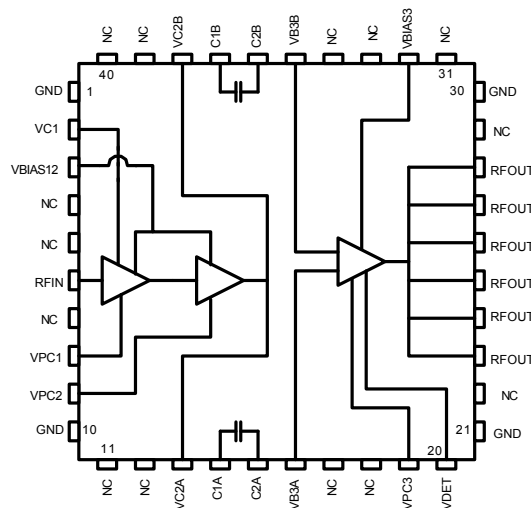



Preliminary
SZM-3066Z 3.3-3.8GHz 2W Power Amp

Measured 3.3 - 3.8 GHz Application Circuit Data ($V_{CC} = V_{PC} = 5.0V$, $I_q = 600mA$, $T=25C$)

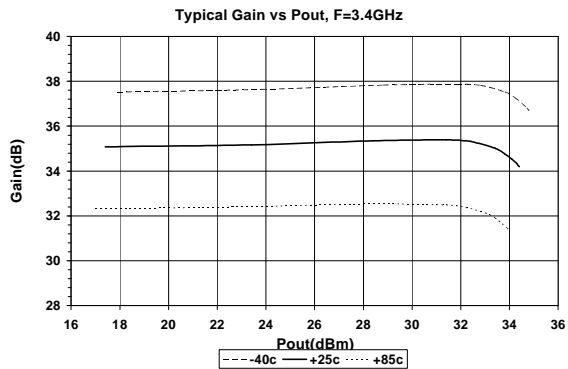
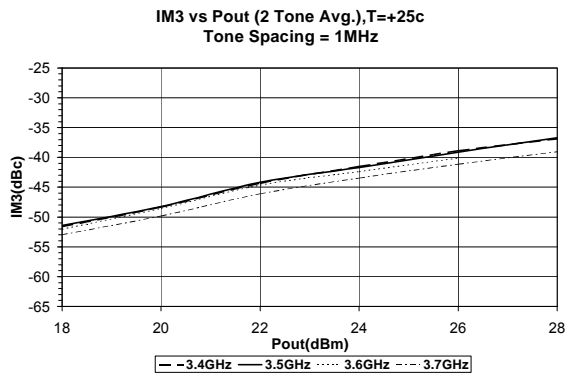
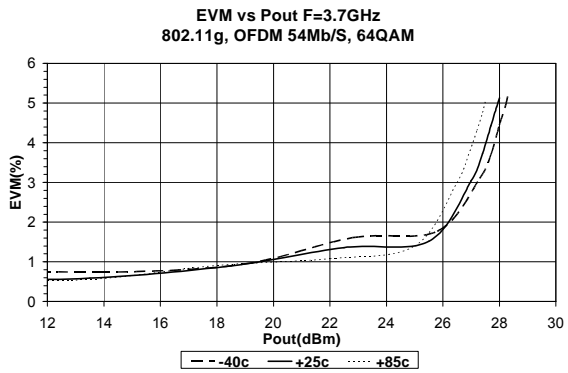
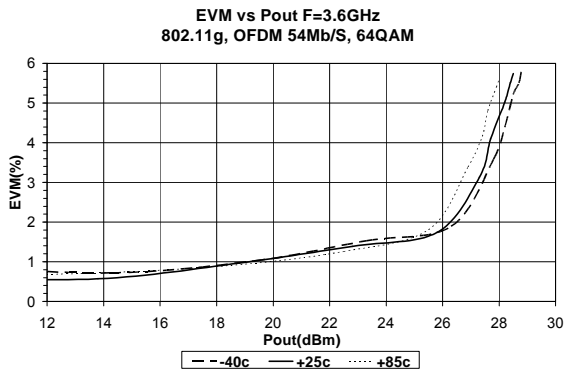
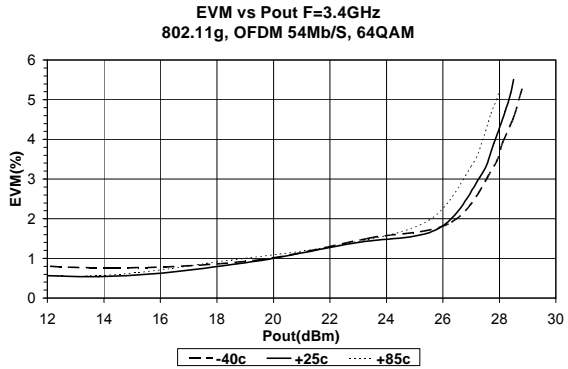
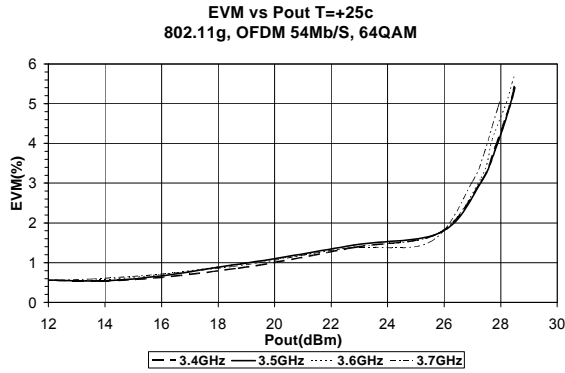



Preliminary
SZM-3066Z 3.3-3.8GHz 2W Power Amp

Measured 3.3 - 3.8 GHz Application Circuit Data ($V_{CC} = V_{DC} = 5.0V$, $I_q = 600mA$, $T = 25C$)

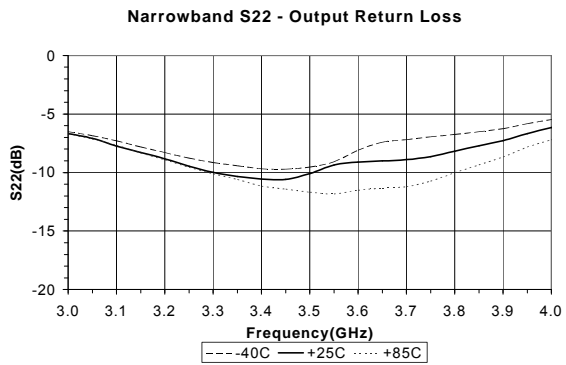
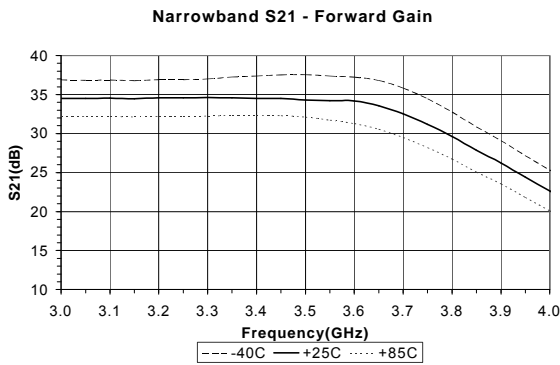
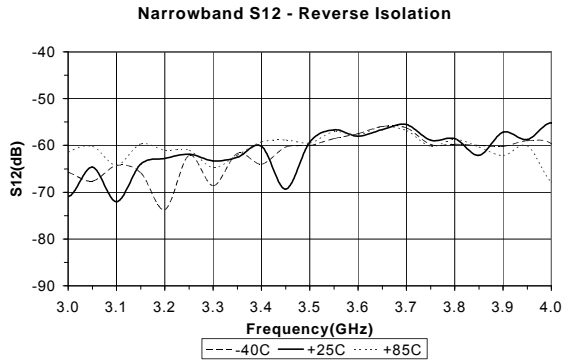
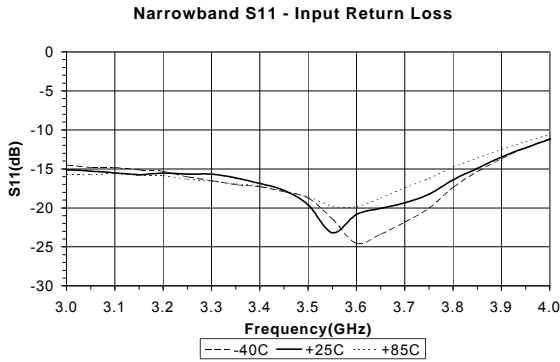
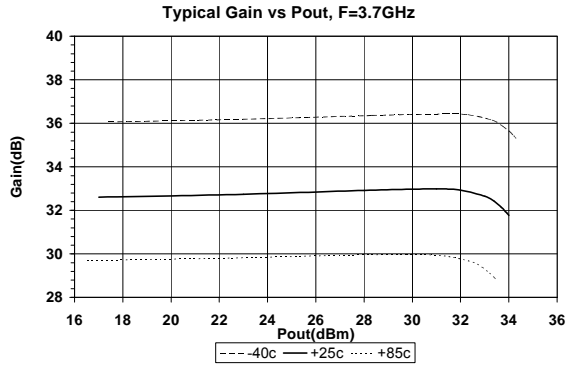
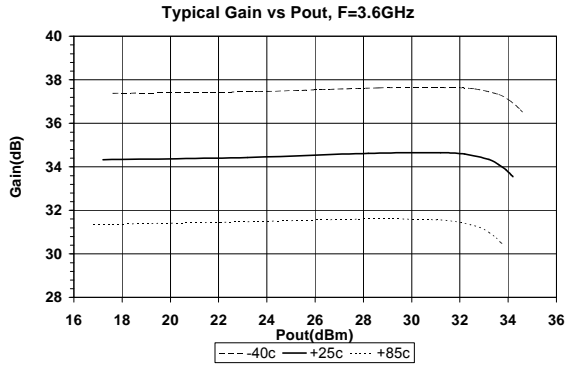



Preliminary
SZM-3066Z 3.3-3.8GHz 2W Power Amp

Measured 3.3 - 3.8 GHz Application Circuit Data ($V_{CC} = V_{PC} = 5.0V$, $I_q = 600mA$, $T=25C$)

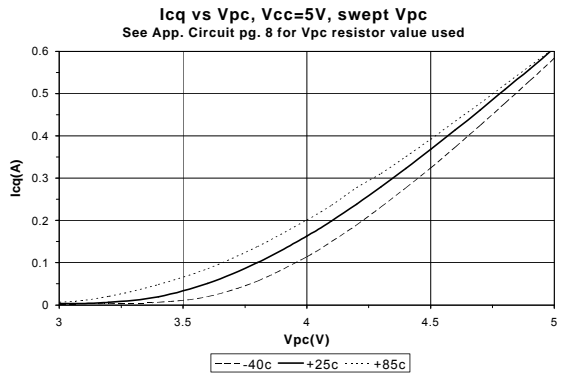
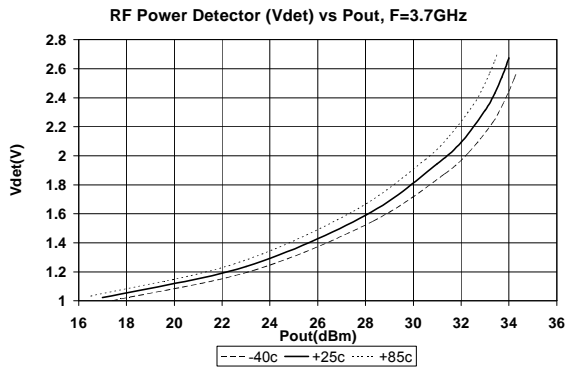
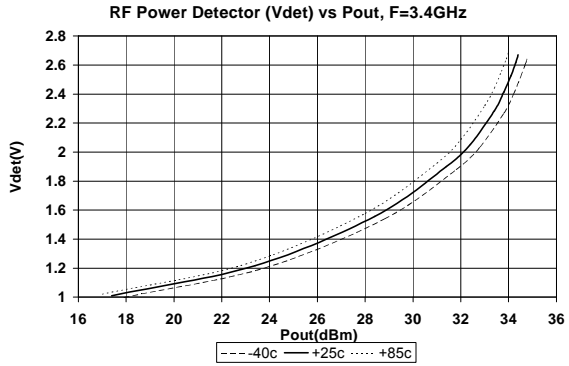
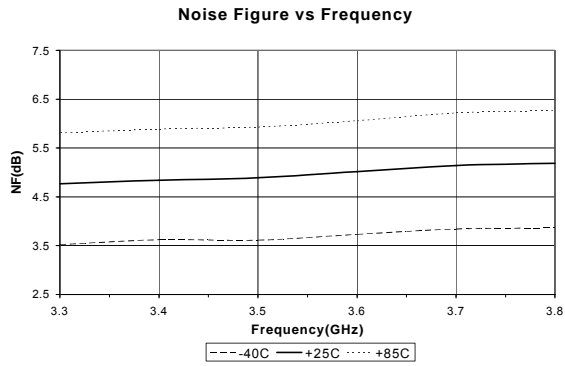
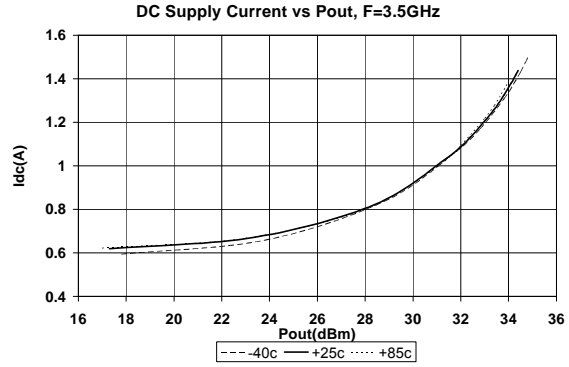
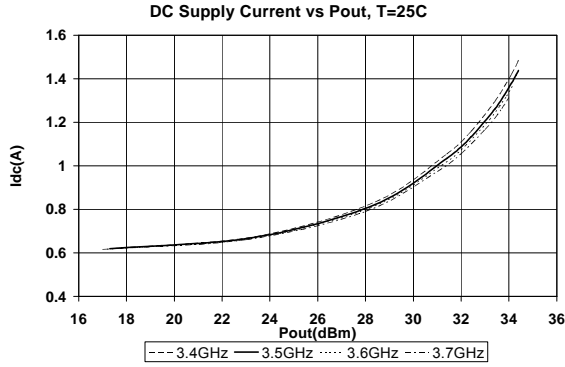



Preliminary
SZM-3066Z 3.3-3.8GHz 2W Power Amp

Measured 3.3 - 3.8 GHz Application Circuit Data ($V_{CC} = V_{PC} = 5.0V$, $I_q = 600mA$, $T=25C$)

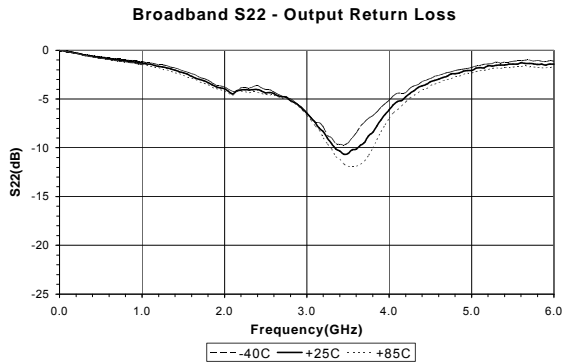
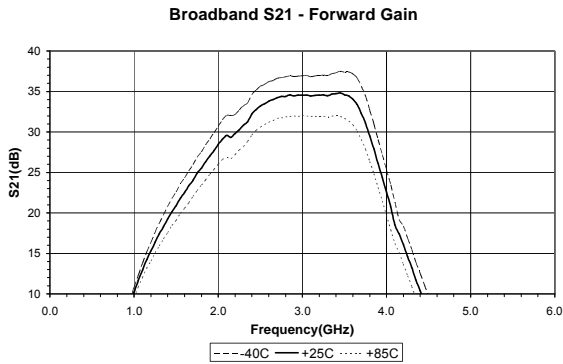
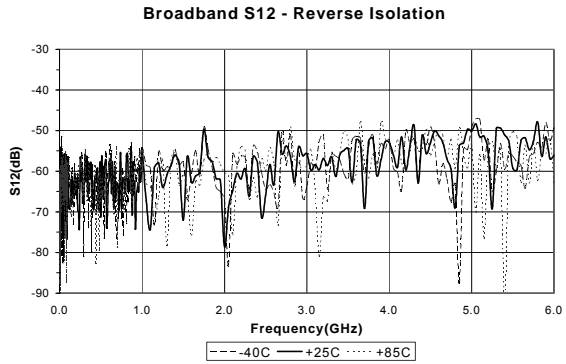
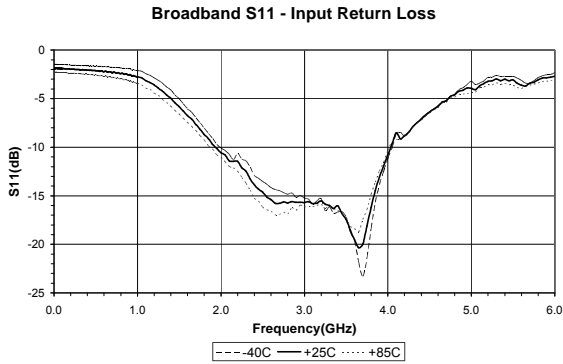

3.3-3.8 GHz Evaluation Board Schematic For Vcc = V+ = Vpc = 5.0V

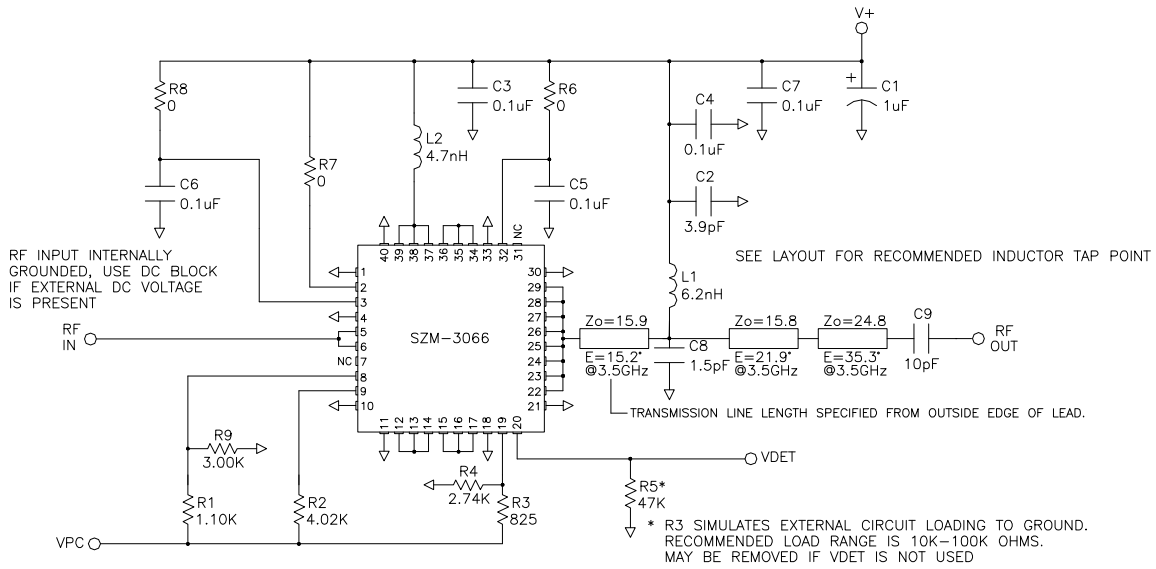

Note: For power up enable (Vpc) voltages < 5V, contact Applications Engineering for the appropriate R1, R9, R2, R3, and R4 values.

3.3-3.8 GHz Evaluation Board Layout For Vcc = V+ = Vpc = 5.0V

Board material GETEK, 10mil thick, Dk=3.9, 2 oz. copper

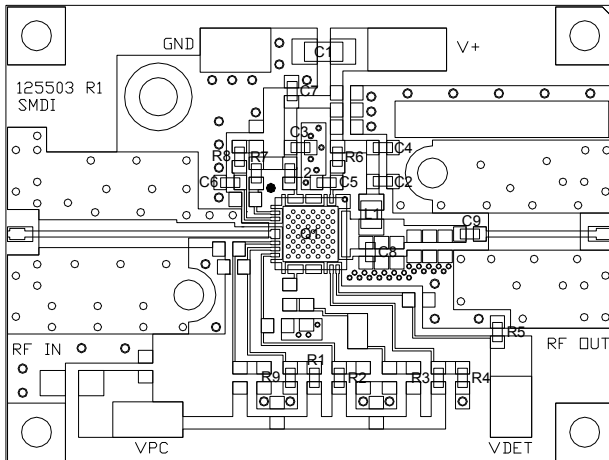

DESG	DESCRIPTION	NOTES
Q1	SZM-3066Z	6x6mm QFN
R1	1.10K OHM, 0603 1%	0402 may be used
R2	4.02K OHM, 0603 1%	"
R3	825 OHM, 0603 1%	"
R4	2.74K OHM, 0603 1%	"
R5	47K OHM, 0603	"
R6,7,8	0 OHM, 0603	"
R9	3K OHM, 0603 1%	"
C1	1uF 16V MLCC CAP	Tantalum ok for EVM performance Use MLCC type for best IM3 levels
C2	3.9pF CAP, 0603	NPO ROHM MCH185A3R9DK or equiv.
C3,4,5,6,7	0.1uF CAP, 0603	NPO 0402 ok ROHM MCH184CN105K or equiv.
C8	1.5pF CAP, 0603	NPO, low ESR ATC 600S1R5CW250 or equiv.
C9	10pF CAP, 0603	NPO, low ESR ATC 600S100JW250 or equiv.
L1	6.2nH IND 0805	Coilcraft 0805HQ - 6N2XJBB
L2	4.7nH IND, 0603	TOKO 0603 - LL1608FH4N7J



Preliminary
SZM-3066Z 3.3-3.8GHz 2W Power Amp

Part Symbolization

The part will be symbolized with "SZM-3066Z" to designate it as a RoHS green compliant product. Marking designator will be on the top surface of the package.

Part Number Ordering Information

Part Number	Reel Size	Devices/Reel
SZM-3066Z	13"	3000

Package Outline Drawing (dimensions in mm):

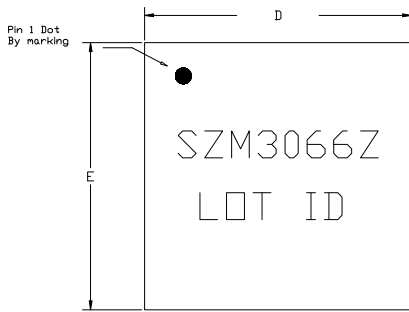

TOP VIEW

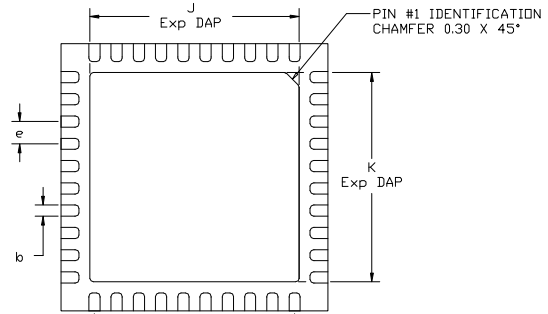

BOTTOM VIEW

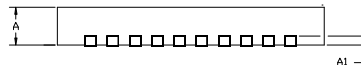

SIDE VIEW

DIM	Min	Nom	Max
A	.80	.85	.90
A1		.20	
b	.20	.25	.30
D	5.95	6.0	6.05
e		0.5 BSC	
E	5.95	6.0	6.05
J	4.65	4.70	4.75
K	4.65	4.70	4.75

Recommended Metal Land Pattern (dimensions in mm[in]):

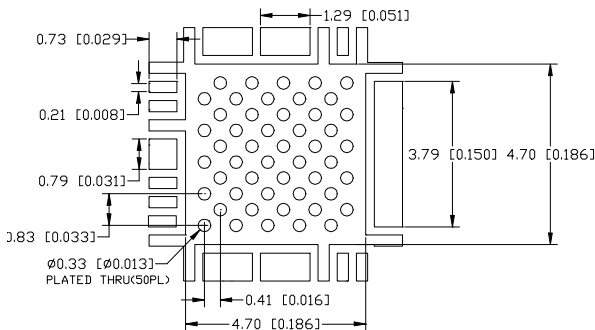

Recommended PCB Soldermask for Land Pattern (dimensions in mm[in]):

