

SCD Series



Various high power surface mountable type inductors provide superior high saturation. The magnetic shielding also protects against radiation.

Features

- RoHS compliant
- High saturation open type wire wound power inductor
- Suitable for large currents
- Ideal for DC – DC converter applications
- Available on tape and reel for auto surface mounting

Applications

- Power supply for VTRs
- OA equipment
- LCD televisions
- Notebook PCs
- Portable communication devices
- DC / DC converters, etc

Product Identification

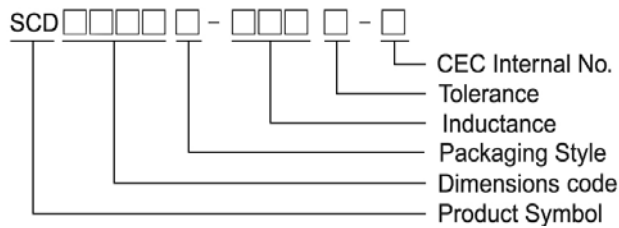

- Packaging: T : Tape and Reel

Shape and Dimensions

SCD 03011 ~ 1006

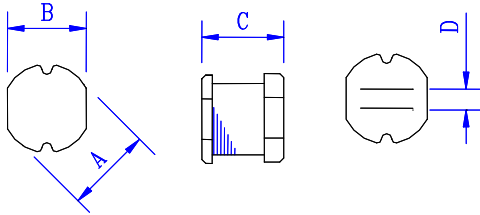

SCD 1307

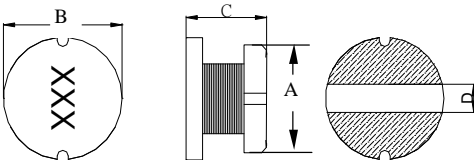

Dimensions in mm

TYPE	A	B	C	D
SCD 03011	3.5 ± 0.3	3.0 ± 0.3	1.1 ± 0.3	1.0 Typ.
SCD 03015	3.3 ± 0.3	3.0 ± 0.3	1.5 ± 0.3	1.0 Typ.
SCD 03021	3.3 ± 0.3	3.0 ± 0.3	2.1 ± 0.3	1.0 Typ.
SCD 0403	4.5 ± 0.3	4.0 ± 0.3	3.2 ± 0.3	1.2
SCD 0501	5.8 ± 0.3	5.2 ± 0.3	2.2 ⁺⁰	2.0 Typ.
SCD 0502	5.8 ± 0.3	5.2 ± 0.3	2.5 ± 0.3	2.0 Typ.
SCD 0503	5.8 ± 0.3	5.2 ± 0.3	3 ± 0.3	2.0 Typ.
SCD 0504	5.8 ± 0.3	5.2 ± 0.3	4.5 ± 0.4	1.3
SCD 0506	5.8 ± 0.3	5.2 ± 0.3	6.0 ± 0.4	1.3
SCD 0703	7.8 ± 0.3	7.0 ± 0.3	3.5 ± 0.3	2.1
SCD 0705	7.8 ± 0.3	7.0 ± 0.3	5.0 ± 0.3	2.1
SCD 0706	7.8 ± 0.3	7.0 ± 0.3	6.0 ± 0.3	2.1
SCD 1004	10.0 ± 0.3	9.0 ± 0.3	4.0 ± 0.5	2.1
SCD 1005	10.0 ± 0.4	9.0 ± 0.4	5.4 ± 0.4	2.1
SCD 1006	10.0 ± 0.4	9.0 ± 0.4	6.5 ± 0.4	2.1
SCD 1307	13.0 ± 0.5	13.0 ± 0.5	7.0 ± 0.3	5 Typ.

Recommended Pattern

SCD 1307

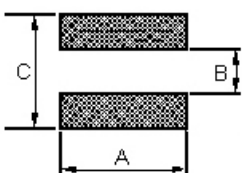

Dimensions in mm

Dim	A	B	C
1307	14	4.5	14

SCD03011-SCD1006

Dimensions in mm

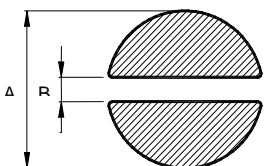

PAD LAYOUT

Dim	SCD 03011	SCD 03015	SCD 03021	SCD 0403	SCD 0501	SCD 0502	SCD 0503	SCD 0504	SCD 0506	SCD 0703	SCD 0705	SCD 0706	SCD 1004	SCD 1005	SCD 1006
A	4.5	4.5	4.5	5.5	6.8	6.8	6.8	6.8	6.8	8.8	8.8	8.8	11	11	11
B	1.5	1.0	1.0	1.2	2.0	2.0	2.0	1.3	1.3	2.1	2.1	2.1	2.1	2.1	2.1

Standard Specifications

Stamp	Inductance (μH)	RDC (Ω) Max														
		SCD 03011	SCD 03015	SCD 03021	SCD 0403	SCD 0501	SCD 0502	SCD 0503	SCD 0504	SCD 0506	SCD 0703	SCD 0705	SCD 0706	SCD 1004	SCD 1005	SCD 1006
R15	0.15				0.0085											
1R0	1.0	0.084		0.07	0.033	0.034	0.03	0.03								
1R2	1.2							0.03								
1R4	1.4			0.09	0.038	0.048	0.04						0.02			
1R5	1.5	0.126						0.03								
1R8	1.8			0.11	0.042	0.062	0.05	0.03					0.02			
2R2	2.2	0.18	0.10±30%	0.13	0.047	0.064	0.06	0.03								
2R7	2.7			0.14	0.052	0.078	0.07	0.04					0.02			
3R3	3.3	0.27		0.17	0.058	0.097	0.08	0.05								
3R9	3.9	0.32		0.19	0.076	0.105	0.09	0.06					0.03			
4R7	4.7	0.33	0.15±30%	0.21	0.094	0.134	0.14	0.07					0.04			0.040
5R6	5.6	0.48		0.22	0.101	0.170	0.15	0.08					0.04			
6R8	6.8	0.56		0.25	0.117	0.187	0.16	0.09					0.04			0.037
8R2	8.2	0.62		0.28	0.132	0.225	0.17	0.10					0.05			
100	10	0.90	0.30±30%	0.32	0.182	0.255	0.18	0.12	0.10			0.08	0.07		0.05	0.060
120	12	1.00		0.35	0.210	0.292	0.20	0.13	0.12			0.09	0.08		0.06	0.070
150	15	1.10	0.58±30%	0.40	0.235	0.360	0.22	0.15	0.14			0.10	0.09	0.08	0.07	0.080
180	18	1.24		0.48	0.338	0.430	0.25	0.22	0.15			0.11	0.10		0.08	0.090
220	22	1.40	0.71±30%	0.58	0.378	0.492	0.35	0.22	0.18	0.165		0.13	0.11		0.09	0.100
270	27	2.18		0.65	0.522	0.603	0.45	0.26	0.20			0.15	0.12		0.10	0.110
330	33	2.54	1.10±30%	0.80	0.540	0.796	0.56	0.33	0.23			0.17	0.13	0.14	0.12	0.120
390	39	2.80		0.90	0.587	0.897	0.69	0.42	0.32			0.22	0.16		0.15	0.140
470	47	3.10	1.30±30%	1.19	0.844	1.020	0.72	0.50	0.37			0.25	0.18		0.17	0.170
500	50	3.20		1.22		1.040										
560	56	3.50		1.27	0.937	1.164	0.84	0.55	0.42			0.28	0.24		0.20	0.190
680	68	5.80	2.20±30%	1.73	1.117	1.220	0.90	0.65	0.46			0.33	0.28		0.22	0.220
750	75	6.10		1.90		1.340										
820	82	6.60		1.99		1.570	1.20	0.80	0.60			0.41	0.37		0.30	0.25
101	100		3.50±30%	2.52	2.000	1.800	1.30	0.90	0.70			0.48	0.43		0.34	0.35
121	120			2.90	1.800	2.000	1.38	1.00	0.93			0.54	0.47		0.40	0.40
151	150			3.36	2.800	2.80	1.81	1.30	1.10			0.75	0.64		0.54	0.47
181	180			5.10	3.200	3.15	1.95	1.50	1.38			1.02	0.71		0.62	0.63
221	220			5.80	4.000	4.40	3.00	2.00	1.57			1.20	0.96		0.72	0.73
271	270			7.80		6.40	3.20	2.50	1.85			1.31	1.11		0.95	0.97
301	300			8.10		6.75										
331	330			9.24	5.850	7.20	3.82	3.20	2.00			1.50	1.26		1.10	1.15
391	390			10.14		8.40	4.68	3.50	2.60				1.77		1.24	1.30
461	460			11.15		12.0										
471	470			11.48		12.4	5.10	4.20	3.00			1.96			1.53	1.48
561	560			19.49		13.0	8.50	4.50	4.19						1.90	1.90
681	680							10.0	6.50	4.44						2.25
821	820							12.0	7.50	5.12						2.55
102	1000							18.0	8.00	10.00						
122	1200															
152	1500															
602	6000															14
822	8200															50

Test Freq.(L): SCD03011: (100KHz/1V) SCD03015: (1MHz/1V)
 SCD03021/0403/0501/0502/ 0503: 0.15 ~ 8.2μH(7.96MHz/1V), 10 ~ 82μH (2.52MHz/1V), 100 ~ 1000μH (1KHz/1V).
 SCD0504/0506/0703/0705/0706/1004: 1.0 ~ 8.2μH(7.96MHz/1V), 10 ~ 82μH (2.52MHz/1V), 100 ~ 1000μH (1KHz/1V).
 SCD1005/1006: 1.0 ~ 8.2μH(7.96MHz/1V), 10 ~ 82μH (2.52MHz/1V), 100 ~ 1000μH (1KHz/1V).

Test Instrument: L: Agilent/ E4980 or HP4284A (over 1MHz), HP4285A (under 1MHz)
 DCR: CH502BC ; Rated D.C. Current: HP4284+42841A or WK3260B+WK3265B

Standard Specifications

Stamp	Inductance (μH)	Isat (A) Max														
		SCD03011	SCD03015	SCD03021	SCD0403	SCD0501	SCD0502	SCD0503	SCD0504	SCD0506	SCD0703	SCD0705	SCD0706	SCD1004	SCD1005	SCD1006
R15	0.15				7.5											
1R0	1.0	1.80		2.080	3.80	4.00	4.50	4.50								
1R2	1.2							4.20								
1R4	1.4			1.860	3.30	3.60	4.00					3.70				
1R5	1.5	1.44						4.10								
1R8	1.8			1.800	2.91	3.00	3.30	3.70				3.70				
2R2	2.2	1.26	0.79	1.390	2.60	2.65	2.94	3.50								
2R7	2.7			1.320	2.43	2.20	2.50	3.20				3.70				
3R3	3.3	1.08		1.250	2.15	2.11	2.35	2.80								
3R9	3.9	1.00		1.200	1.98	2.00	2.20	2.60				3.70				
4R7	4.7	0.90	0.65	1.130	1.70	1.80	2.00	2.50				3.50			2.60	
5R6	5.6	0.76		0.910	1.60	1.60	1.80	2.40				3.30				
6R8	6.8	0.68		0.850	1.41	1.50	1.70	2.20				3.10			4.33	
8R2	8.2	0.63		0.820	1.26	1.30	1.40	2.00				2.70				
100	10	0.56	0.45	0.740	1.15	1.10	1.20	1.80	1.44		1.44	2.30		2.38	2.60	
120	12	0.52		0.640	1.05	1.05	1.18	1.75	1.40		1.39	2.00		2.13	2.45	
150	15	0.50	0.30	0.600	0.92	1.00	1.15	1.70	1.30		1.24	1.80	2.8	1.87	2.27	
180	18	0.46		0.540	0.84	0.95	1.10	1.60	1.23		1.12	1.60		1.73	2.15	
220	22	0.36	0.25	0.500	0.76	0.90	1.00	1.50	1.11	1.6	1.07	1.50		1.60	1.95	
270	27	0.30		0.430	0.71	0.77	0.86	1.40	0.97		0.94	1.30		1.44	1.76	
330	33	0.28	0.20	0.400	0.64	0.68	0.76	1.10	0.88		0.85	1.20	2.3	1.26	1.50	
390	39	0.26		0.370	0.59	0.67	0.75	1.00	0.80		0.74	1.10		1.20	1.37	
470	47	0.25	0.17	0.360	0.54	0.66	0.73	0.90	0.72		0.68	1.10		1.10	1.28	
500	50	0.24		0.330		0.61										
560	56	0.23		0.310	0.50	0.50	0.55	0.85	0.68		0.64	0.94		1.01	1.17	
680	68	0.20	0.13	0.300	0.46	0.47	0.52	0.80	0.61		0.59	0.85		0.91	1.11	
750	75	0.18		0.290		0.46										
820	82	0.17		0.280		0.45	0.50	0.65	0.58		0.54	0.78		0.85	1.00	
101	100		0.10	0.250	0.40	0.36	0.40	0.60	0.52		0.51	0.72		0.74	0.97	
121	120			0.200	0.38	0.32	0.36	0.58	0.48		0.49	0.66		0.69	0.89	
151	150			0.190	0.30	0.270	0.30	0.43	0.40		0.40	0.58		0.61	0.78	
181	180			0.170	0.25	0.230	0.26	0.41	0.38		0.36	0.51		0.56	0.72	
221	220			0.160	0.15	0.220	0.25	0.38	0.35		0.31	0.49		0.53	0.66	
271	270			0.140		0.190	0.21	0.35	0.29		0.29	0.42		0.45	0.57	
301	300			0.135		0.180										
331	330			0.130	0.21	0.16	0.18	0.28	0.28		0.28	0.40		0.42	0.52	
391	390			0.120		0.150	0.16	0.26	0.26			0.36		0.38	0.48	
461	460			0.090		0.140										
471	470			0.084		0.135	0.15	0.20	0.12			0.34		0.35	0.42	
561	560			0.080		0.130	0.14	0.19	0.10					0.32	0.33	
681	680						0.13	0.18	0.08						0.28	
821	820						0.07	0.15	0.05						0.24	
102	1000						0.05	0.13	0.03							
122	1200															
152	1500															
602	6000															0.27
822	8200															0.20

Tolerance Of Inductors

- SCD03011 1.0 ~ 82μH ± 20%
- SCD03015 2.2 ~ 100μH ± 20%
- SCD03021 1.0 ~ 560μH ± 20%
- SCD0403 0.15 ~ 27μH ± 20% 33 ~ 100μH ± 10%
- SCD0501 1.0 ~ 27μH ± 20% 33 ~ 560μH ± 10%
- SCD0502 1.0 ~ 27μH ± 20% 33 ~ 1000μH ± 10%
- SCD0503 1.0 ~ 27μH ± 20% 33 ~ 1000μH ± 10%
- SCD0504 1.0~27μH±20% 33~47μH ±15% 56~1000μH±10%
- SCD0506 22μH ± 20%
- SCD0703 10 ~ 27μH ± 20% 33 ~ 330μH ±10%
- SCD0705 1.4 ~ 27μH ± 20% 33 ~ 470μH ±10%
- SCD0706 15μH ± 20% 33μH ±10%
- SCD1004 10 ~ 27μH ± 20% 33 ~ 560μH ±10%
- SCD1005 4.7 ~ 27μH ± 20% 33 ~ 820μH ±10%
- SCD1006 4.7 ~ 27uH ± 20% 33 ~820uH ± 10%
- SCD1006 6000μH ~8200μH±20%

Tolerance: K = ±10% , M = ±20%

※ This indicates the value of current when the inductance is 10% lower than its initial value at D.C superposition or D.C current when at Δt = 40° whichever is lower

Electrical Characteristics

Part Number	Inductance (μ H)	Tolerance (\pm %)	Q Ref	Q Frequency (MHz)	SRF (MHz) Typ.	DC Resistance (m Ω) Typ.	I _{rms} (A) Max	I _{sat} (A) Typ.
SCD1307T-1R5□-N	1.5	20	20	7.96 / 0.1V	65	5.0	9.50	20.0
SCD1307T-2R2□-N	2.2	20	22	7.96 / 0.1V	50	6.0	9.00	18.0
SCD1307T-2R7□-N	2.7	20	24	7.96 / 0.1V	40	8.0	8.20	16.0
SCD1307T-3R3□-N	3.3	20	26	7.96 / 0.1V	38	8.7	7.50	15.0
SCD1307T-4R7□-N	4.7	20	25	7.96 / 0.1V	36	10	7.00	13.0
SCD1307T-5R6□-N	5.6	20	24	7.96 / 0.1V	28	15	6.50	11.0
SCD1307T-6R8□-N	6.8	20	24	7.96 / 0.1V	26	17	6.00	10.5
SCD1307T-8R2□-N	8.2	20	24	7.96 / 0.1V	24	19	5.80	9.8
SCD1307T-100□-N	10	20	22	2.52 / 0.1V	22	21	5.60	9.2
SCD1307T-120□-N	12	20	25	2.52 / 0.1V	20	30	4.80	8.0
SCD1307T-150□-N	15	20	28	2.52 / 0.1V	17	34	4.50	7.5
SCD1307T-180□-N	18	20	28	2.52 / 0.1V	16	36	4.20	7.0
SCD1307T-220□-N	22	20	40	2.52 / 0.1V	15	47	3.60	6.5
SCD1307T-270□-N	27	20	35	2.52 / 0.1V	11	60	3.30	5.5
SCD1307T-330□-N	33	20 / 10	35	2.52 / 0.1V	10	65	3.10	5.0
SCD1307T-390□-N	39	20 / 10	28	2.52 / 0.1V	9.0	75	2.90	4.6
SCD1307T-470□-N	47	20 / 10	24	2.52 / 0.1V	7.5	82	2.70	4.2
SCD1307T-560□-N	56	20 / 10	22	2.52 / 0.1V	7.2	95	2.50	3.8
SCD1307T-680□-N	68	20 / 10	24	2.52 / 0.1V	7.0	120	2.30	3.5
SCD1307T-820□-N	82	20 / 10	18	2.52 / 0.1V	6.0	140	2.10	3.2
SCD1307T-101□-N	100	20 / 10	25	0.796 / 0.1V	5.8	180	1.90	3.0
SCD1307T-121□-N	120	20 / 10	20	0.796 / 0.1V	5.5	210	1.80	2.8
SCD1307T-151□-N	150	20 / 10	20	0.796 / 0.1V	4.5	250	1.60	2.6
SCD1307T-181□-N	180	20 / 10	18	0.796 / 0.1V	4.0	280	1.50	2.3
SCD1307T-221□-N	220	20 / 10	15	0.796 / 0.1V	3.8	360	1.30	2.1
SCD1307T-271□-N	270	20 / 10	15	0.796 / 0.1V	3.5	410	1.20	1.8
SCD1307T-331□-N	330	20 / 10	15	0.796 / 0.1V	3.2	520	1.10	1.6
SCD1307T-391□-N	390	20 / 10	12	0.796 / 0.1V	2.5	600	1.00	1.5
SCD1307T-471□-N	470	20 / 10	12	0.796 / 0.1V	2.2	720	0.90	1.4
SCD1307T-561□-N	560	20 / 10	10	0.796 / 0.1V	2.0	880	0.85	1.3
SCD1307T-681□-N	680	20 / 10	10	0.796 / 0.1V	1.6	1000	0.80	1.2
SCD1307T-821□-N	820	20 / 10	10	0.796 / 0.1V	1.5	1300	0.75	1.1
SCD1307T-102□-N	1000	20 / 10	10	0.252 / 0.1V	1.4	1600	0.65	1.0

- When ordering, please specify tolerance and packaging codes.
- Inductance tested at 0.1 V_{rms}, 100KHz.
- Tolerance: K = \pm 10% , M = \pm 20%
- Inductance drop = 10%. Typ. at I_{sat}
- Δ T = 40°C rise typ. at I_{rms}
- Test Instrument: L / Q : Agilent/ E4980 or HP4284A (over 1MHz), HP4285A (under 1MHz)
SRF: HP4286A
RDC: CH502BC
I_{sat}: HP4284+42841A or WK3260B+WK3265B

SMD Unshielded Power Inductors - SCD Series

Test Instruments : HP4294A Impedance / Material Analyzer

SCD0403

INDUCTANCE vs. FREQUENCY CHARACTERISTICS

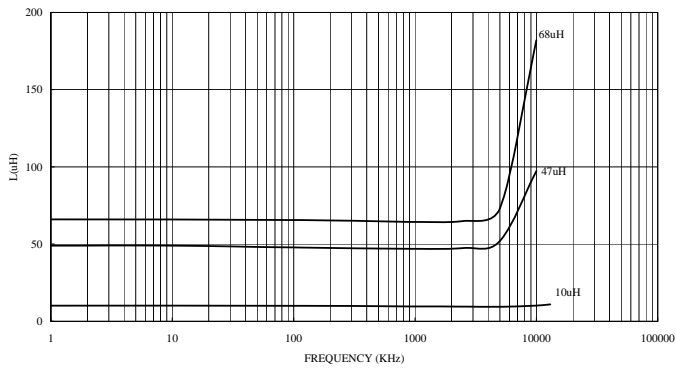

INDUCTANCE vs. IDC CHARACTERISTICS

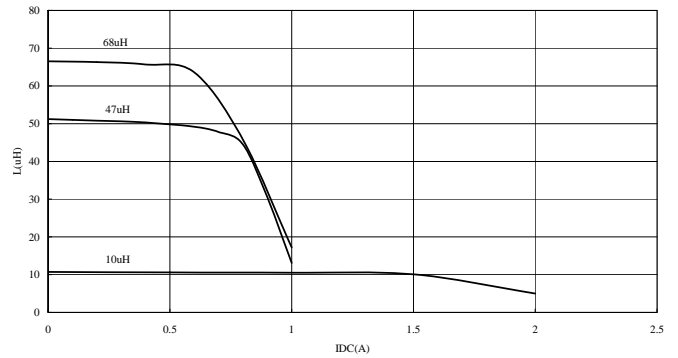

SCD0504

INDUCTANCE vs. FREQUENCY CHARACTERISTICS

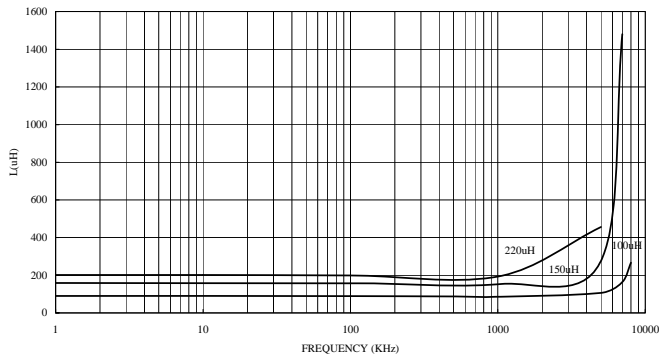

INDUCTANCE vs. IDC CHARACTERISTICS

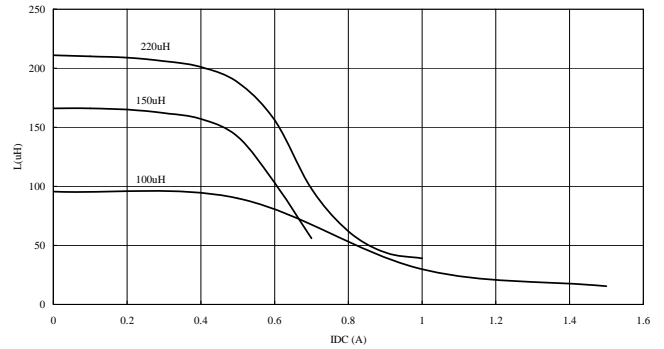

SCD0703

INDUCTANCE vs. FREQUENCY CHARACTERISTICS

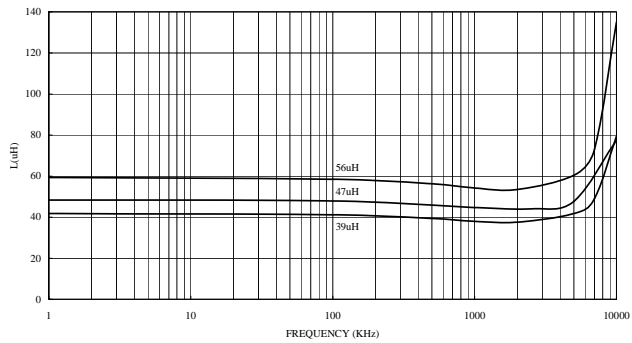

INDUCTANCE vs. IDC CHARACTERISTICS

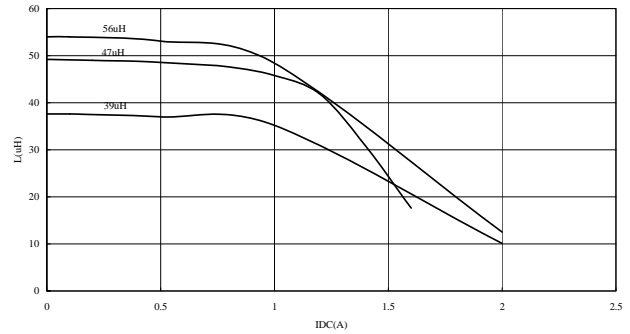

SMD Unshielded Power Inductors - SCD Series

Test Instruments : HP4294A Impedance / Material Analyzer

SCD0705

INDUCTANCE vs. FREQUENCY CHARACTERISTICS

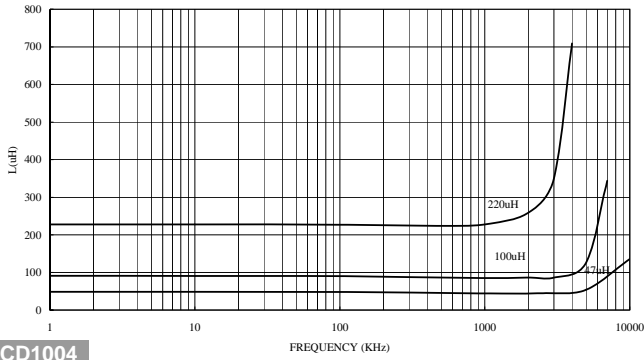

INDUCTANCE vs. IDC CHARACTERISTICS

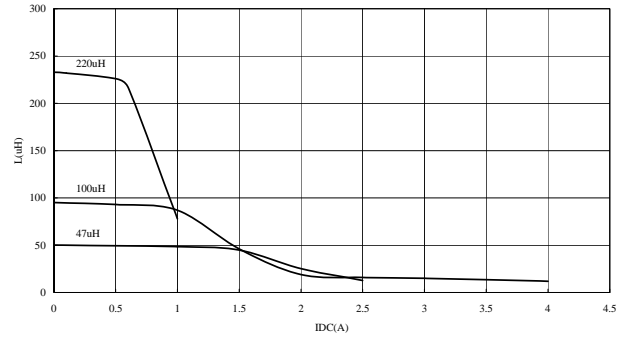

SCD1004

INDUCTANCE vs. FREQUENCY CHARACTERISTICS

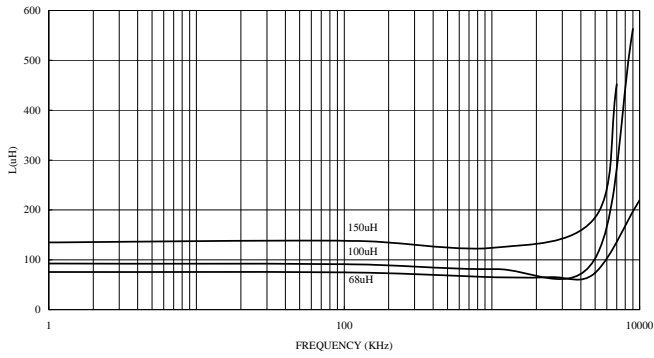

INDUCTANCE vs. IDC CHARACTERISTICS

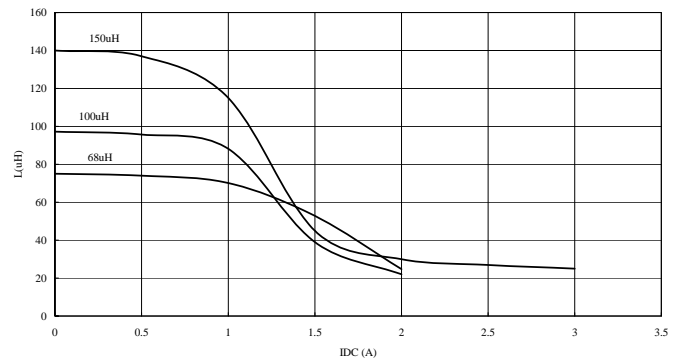

SCD1005

INDUCTANCE vs. FREQUENCY CHARACTERISTICS

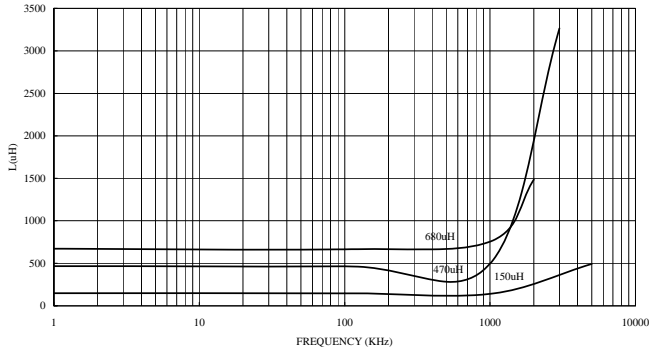

INDUCTANCE vs. IDC CHARACTERISTICS

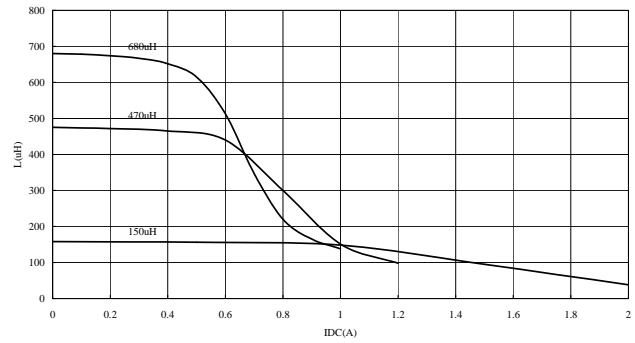

Packaging Specifications

Tape Dimensions

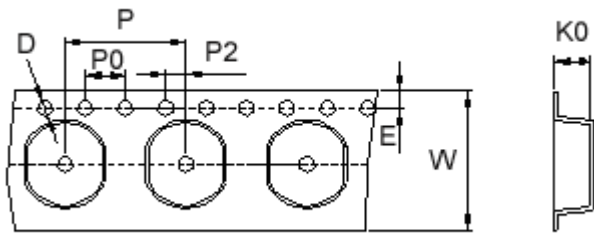

Tape Material

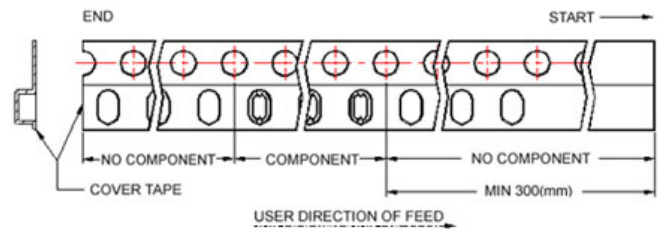

Reel Dimensions

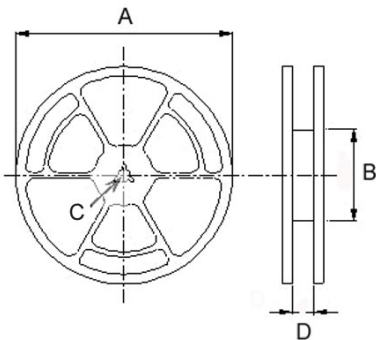

Dimensions in mm

TYPE	Tape Dimensions							Reel Dimensions				Quantity PCS / REEL
	K0	D	E	W	P	P0	P2	A	B	C	D	
SCD03011	1.4	1.50	1.75	12	8	4	2	330	100	13	13.4	3000
SCD03015	1.80	1.55	1.75	12	8	4	2	330	100	13	13.4	3000
SCD03021	2.50	1.55	1.75	12	8	4	2	330	100	13	13.4	3000
SCD0403	3.55	1.55	1.75	12	8	4	2	330	100	13	13.4	2000
SCD0501	2.35	1.55	1.75	12	8	4	2	330	100	13	13.4	2000
SCD0502	3.30	1.50	1.75	16	8	4	2	330	100	13	17.4	2000
SCD0503	3.30	1.50	1.75	16	8	4	2	330	100	13	17.4	2000
SCD0504	4.8	1.55	1.75	16	8	4	2	330	100	13	17.4	1500
SCD0506	6.4	1.55	1.75	16	8	4	2	330	100	13	17.4	1500
SCD0703	3.8	1.55	1.75	16	12	4	2	330	100	13	17.4	1000
SCD0705	5.2	1.55	1.75	16	12	4	2	330	100	13	17.4	700
SCD0706	6.4	1.55	1.75	16	12	4	2	330	100	13	17.4	700
SCD1004	4.5	1.55	1.75	24	12	4	2	330	100	13	24.4	700
SCD1005	5.8	1.55	1.75	24	12	4	2	330	100	13	24.4	700
SCD1006	7.0	1.55	1.75	24	12	4	2	330	100	13	24.4	500
SCD1307	7.4	1.55	1.75	24	16	4	2	330	100	13	24.4	500