

# ISL8225MEVAL2Z 6-Phase, 90A Evaluation Board Setup Procedure

The ISL8225M is a complete, dual step-down switching mode DC/DC module. The dual outputs can easily be paralleled for single-output, high-current use. It is easy to apply this high-power, current-sharing DC/DC power module to power-hungry datacom, telecom, and FPGA applications. All that is needed in order to have a complete, dual 15A design ready for use are the ISL8225M, a few passive components, and  $V_{OUT}$  setting resistors.

The ease of use virtually eliminates design and manufacturing risks while dramatically improving time to market. Need more output current? Simply parallel up to six ISL8225M modules to scale up to an 180A solution.

The ISL8225M has a thermally enhanced, compact QFN package that operates at full load and over-temperature without requiring forced-air cooling. Easy access to all pins, with few external components, reduces PCB design to a component layer and a simple ground layer.

The ISL8225MEVAL2Z evaluation board allows for a single 6-phase paralleled output, which delivers high current up to 90A. The input voltage is 4.5V to 20V and the default output voltage on this board is set at 1.2V. The current level for this board is 90A with no extra cooling required.

## Related Resources



## Recommended Equipment

- 0V to 20V power supply with at least 10A source current capability
- Electronic load capable of sinking current up to 90A (multiple electronic current loads can be used in parallel to sink more current)
- Digital multimeters (DMMs)
- 100MHz quad-trace oscilloscope

## Quick Start

The inputs are J3 (VIN) and J4 (GND). The outputs are J1 and J5 (VOUT), J2 and J6 (GND) and J6 (VOUT2). Please refer to Figure 1. This 90A evaluation board can be easily modified to 30A (one module) or 60A (two modules) operation.

1. Connect a power supply capable of sourcing at least 10A to the input (VIN J3 & GND J4) of the ISL8225MEVAL2Z evaluation board, with a voltage between 4.5V to 20V. Connect an electronic load or the device to be powered to the output (VOUT (J1, J5) & GND (J2, J6)) of the board. All connections, especially the low voltage, high current  $V_{OUT}$  lines, should be able to carry the desired load current and should be made as short as possible. Duplicated tab connections on VOUT (J1, J5) and GND (J2, J6) to carry large current.
2. Ensure the jumpers for EN2 and EN3 are in the “ON” position and EN is open. Turn on the power supply. If the board is working properly, the green LED will illuminate; if not, the red LED will illuminate (recheck the wire/jumper connections in this case). Measure the output voltage,  $V_{OUT}$ , which should be at 1.2V.
3. The ISL8225MEVAL2Z is manufactured with a  $V_{OUT}$  default value of 1.2V; if different output voltages are desired, board resistors can be exchanged to provide the desired  $V_{OUT}$ . Please refer to Table 1 on page 2 for R2/R64 resistor values, which can be used to produce different output voltages.

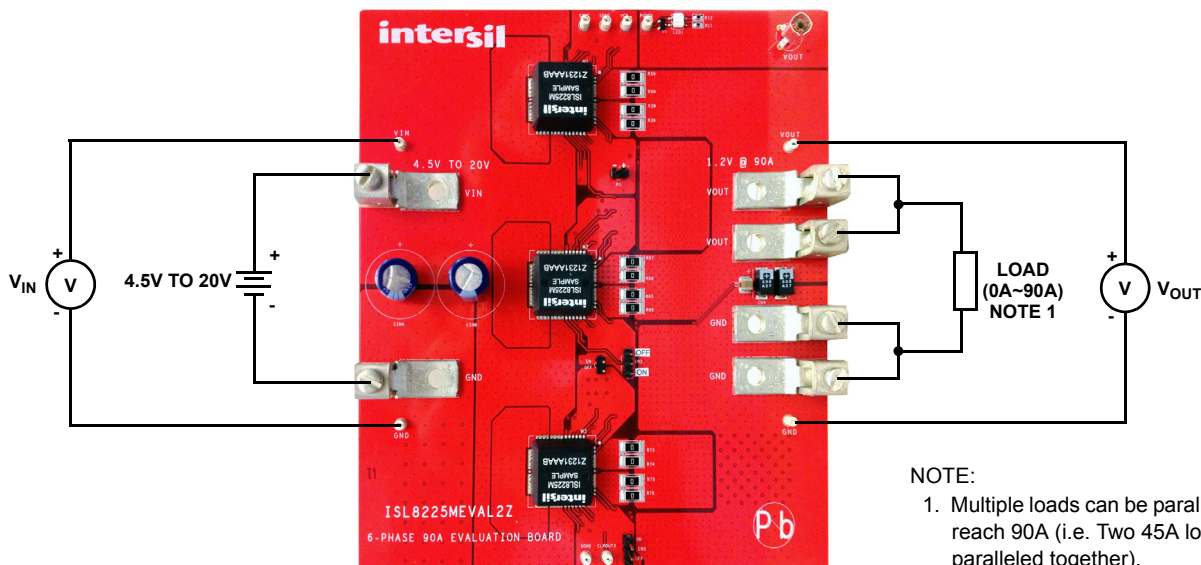

FIGURE 1. ISL8225MEVAL2Z BOARD IMAGE

For 12V  $V_{IN}$  and  $V_{OUT}$  more than 1.5V, the switching frequency will need to be adjusted, as shown in Table 1. The resistor  $R_{FSET}$  can be adjusted for the desired frequency. No frequency adjustments are necessary for  $V_{OUT}$  below 1.5V. For 5V  $V_{IN}$ , the frequency does not need to be adjusted and the module default frequency can be used at any allowed  $V_{OUT}$ . If the output voltage is set to more than 1.8V, the output current will need to be derated to allow for safe operation. Please refer to the derating curves in the [ISL8225M datasheet](#).

**TABLE 1. VALUE OF BOTTOM RESISTOR FOR DIFFERENT OUTPUT VOLTAGES (R1 = 1k)**

$V_{OUT}$ (V)	R2 /R64 (Ω)	FREQUENCY (kHz)	$R_{FSET}$ (Ω) ( $V_{IN} = 12V$ )
0.6	0/0	Default	Default
0.8	3010/1500	Default	Default
1.0	1500750	Default	Default
1.2	1000/500	Default	Default
1.5	665/332	Default	Default
2.5	316/158	650	249k
3.3	221/110	800	124k
5.0	137/68.1	950	82.5k
5.5	121/60.4	950	82.5k

## Board Setting

If low current applications are needed, this 90A evaluation board can be easily programmed to 30A and 60A use.

### 30A Application (1 Module)

EN – Open, EN2– OFF, EN3 – OFF

In this mode, only module 1 is running and modules 2 and 3 are disabled.

### 60A Application (2 Modules)

EN – Open, EN2– ON, EN3 – OFF

Or:

EN – Open, EN2– OFF, EN3 – ON

In this mode, only modules 1 and 2 (or 3) are running and module 3 (or 2) is disabled.

### 90A Application (3 Modules)

EN – Open, EN2– ON, EN3 – ON

In this mode, all modules are running.

### Disable All Modules and Use the EN Pin to Start the Modules

EN – Connected

In this mode, all modules are disabled and EN can be used to control all modules to startup.

## Evaluation Board Information

The evaluation board size is 150mm x 130mm. It is a 6-layer board, containing 2-ounce copper on the top and bottom layers and 1-ounce copper on all internal layers. The board can be used as a 90A reference design. Refer to the “Layout” section beginning on page 7. The board is made of FR4 material and all components, including the solder attachment, are lead-free.

### Current Sharing Check

The evaluation board allows the user to measure the current sharing accuracy. Four zero ohm resistors (i.e. R59~R62 for M1 channel 2 in Figure 2) are put serially on each output with two on each side of the evaluation board. To measure the output current of each phase, please remove all four resistors and put looped wires or sensing resistors on correct positions.

Although the assembled resistors have zero resistance, there is still small resistance (< 50mΩ) on each resistor. At large output current, the efficiency can be decreased by 1~3% due to the power loss on those zero ohm resistors. The efficiency curves are shown in Figures 16 and 17 with zero ohm resistors, while Figures 18 and 19 show the efficiency curves by replacing those resistors with short copper straps.

### Thermal Considerations and Current Derating

For high current applications, board layout is very critical in order to make the module operate safely and deliver maximum allowable power. To carry large currents, the board layout needs to be designed carefully to maximize thermal performance. To achieve this, select enough trace width, copper weight and the proper connectors.

This evaluation board is designed for running 90A @ 1.2V at room temperature without additional cooling systems needed. However, if the output voltage is increased or the board is operated at elevated temperatures, then the available current is derated. Refer to the derated current curves in the [datasheet](#) to determine the output current available.

For layout of designs using the ISL8225M, the thermal performance can be improved by adhering to the following design tips:

1. Use the top and bottom layers to carry the large current. VOUT1, VOUT2, Phase 1, Phase 2, PGND, VIN1 and VIN2 should have large, solid planes. Place enough thermal vias to connect the power planes in different layers under and around the module.
2. Phase 1 and Phase 2 pads are switching nodes that generate switching noise. Keep these pads under the module. For noise-sensitive applications, it is recommended to keep phase pads only on the top and inner layers of the PCB; do not place phase pads exposed to the outside on the bottom layer of the PCB. To improve the thermal performance, the phase pads can be extended in the inner layer, as shown in Phase 1 and 2 pads on layer 3 (Figure 11) for this 90A evaluation board. Make sure that layer 2 and layer 4 have the GND layers to cover the extended areas of phase pads at layer 3 to avoid noise coupling.

# Application Note 1789

- To avoid noise coupling, we recommend adding 1nF capacitors on all COMP and ISHARE pins of each module for multiple module operations.
- Place the modules evenly on the board and leave enough space between modules. If the board space is limited, try to put the modules with low power loss closely together (i.e. low  $V_{OUT}$  or  $I_{OUT}$ ) while still separating the module with high power loss.
- If the ambient temperature is high or the board space is limited, airflow is needed to dissipate more heat from the modules. A heat sink can also be applied to the top side of the module to further improve the thermal performance (heat sink recommendation: Aavid Thermalloy, part number 375424B00034G, [www.aavid.com](http://www.aavid.com)).

## Remote Sensing

The ISL8225MEVAL2Z board allows the user to apply the remote sensing function to loads in order to achieve good output regulation accuracy. To make use of this function, remove resistors R7 and R8 and connect the kelvin sensing lines through the jumper JP4 (RS) to the point of load.

## Phase-shift Programming

In current sharing mode, the phase-shift is needed to interleave the different phases to lower the input and output ripples. As shown in Table 2, there are different sharing modes from 2-phase (180° phase-shift) and 4-phase (90° phase-shift) to 6-phase (60° phase-shift). The master module sends the CLKOUT signal to the SYNC pin of the second module with the phase-shift to its own clock signal. Then the second module synchronizes to the CLKOUT signal of the master module and sends its CLKOUT signal to the third module's SYNC pin. The individual 2 phases of each module are set to be 180° phase-shift by default. This evaluation board is set to mode 5B with 60° phase-shift between phases.

If the MODE pin is not tied to VCC (5A or 5B), all VMON pins of different modules can be tied together, except the VMON pin of the master phase. If mode 7A is needed to allow for 90° phase-shift, the MODE pin has to tie to VCC. In this case, the VMON pin of the associated module needs to be separated by connecting a 1.05kΩ resistor to SGND, as shown in the [ISL8225M datasheet](#).

TABLE 2. ISL8225M 3-MODULE BOARD OPERATION MODES

1 <sup>ST</sup> MODULE (I = INPUT; O = OUTPUT; I/O = INPUT AND OUTPUT, BI-DIRECTION)								MODES OF OPERATION			OUTPUT
MODE	EN2 (I)	EN3 (I)	VSEN2- (I)	MODE (I)	VSEN2+ (I)	CLKOUT/REFIN WRT 1 <sup>ST</sup> (I OR O)	ISHARE (I/O) REPRESENTS WHICH CHANNEL(S) CURRENT	2 <sup>ND</sup> CHANNEL WRT 1 <sup>ST</sup> (O)	OPERATION MODE OF 2 <sup>ND</sup> MODULE	OPERATION MODE OF 3 <sup>RD</sup> MODULE	
5A	0	0	V <sub>CC</sub>	GND	-	60°	Both Channels	180°	-	-	2-Phase
5B	1	1	V <sub>CC</sub>	GND	-	60°	Both Channels	180°	5B	5B	6-Phase
7A	1	0	V <sub>CC</sub>	V <sub>CC</sub>	V <sub>CC</sub>	90°	Both Channels	180°	5A or 7A	-	4-Phase
8	Cascaded Module Operation MODEs 5A+5A+7A+5A+5A+5A/7A, No External Clock Required										12-Phase

# ISL8225MEVAL2Z Board Schematics

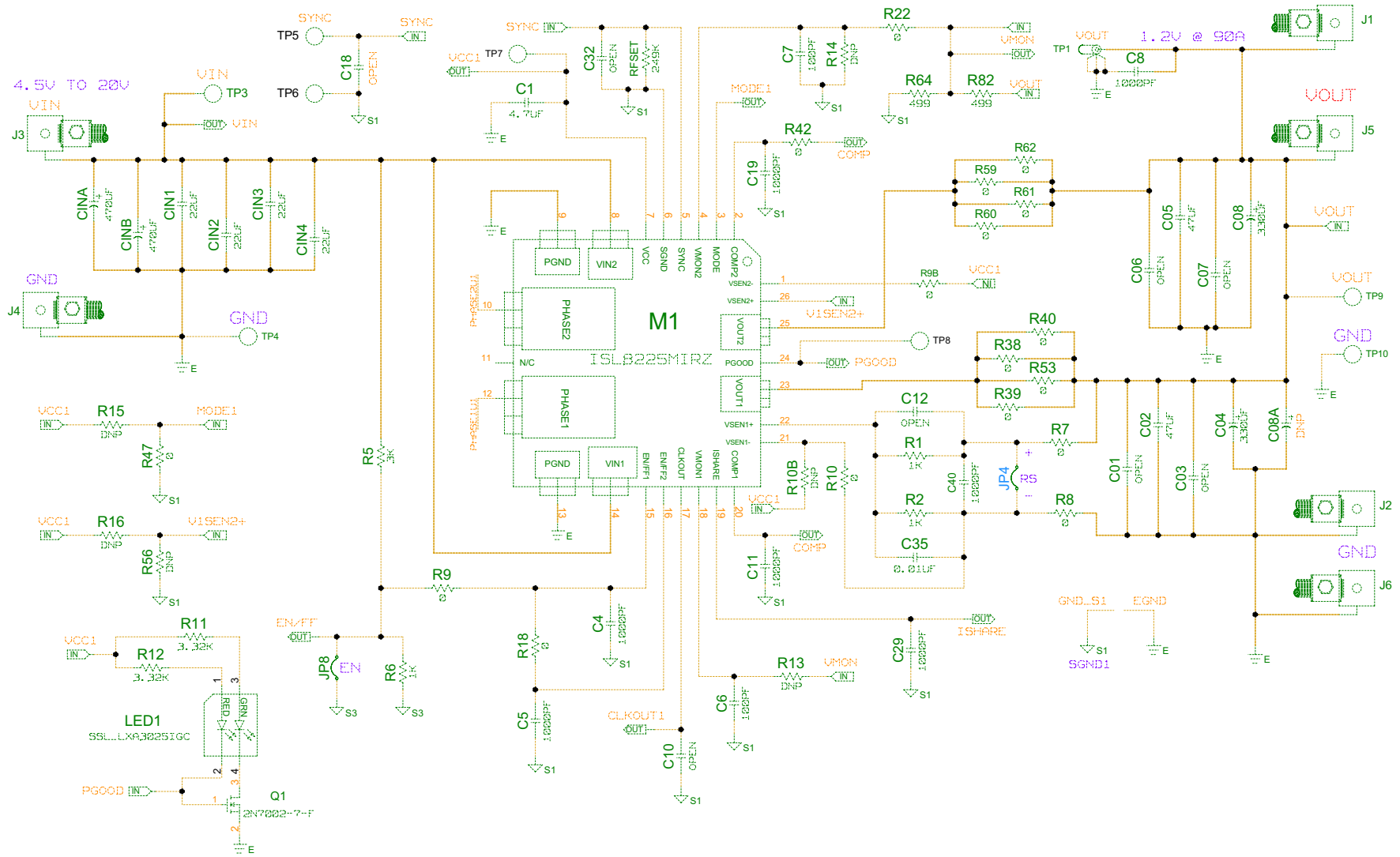

FIGURE 2. ISL8225MEVAL2Z BOARD SCHEMATIC

# ISL8225MEVAL2Z Board Schematics (Continued)

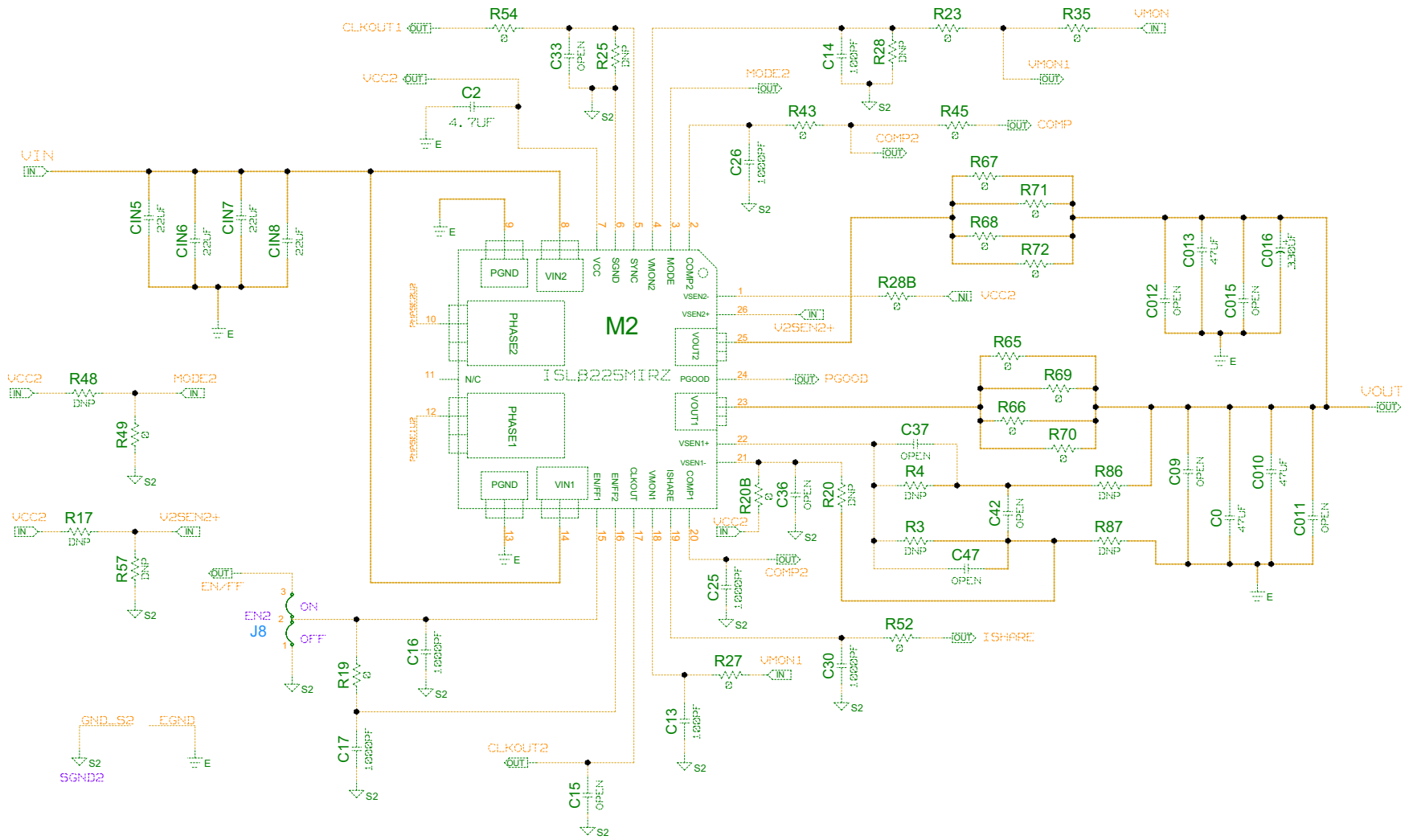

FIGURE 3. ISL8225MEVAL2Z BOARD SCHEMATIC

# ISL8225MEVAL2Z Board Schematics (Continued)

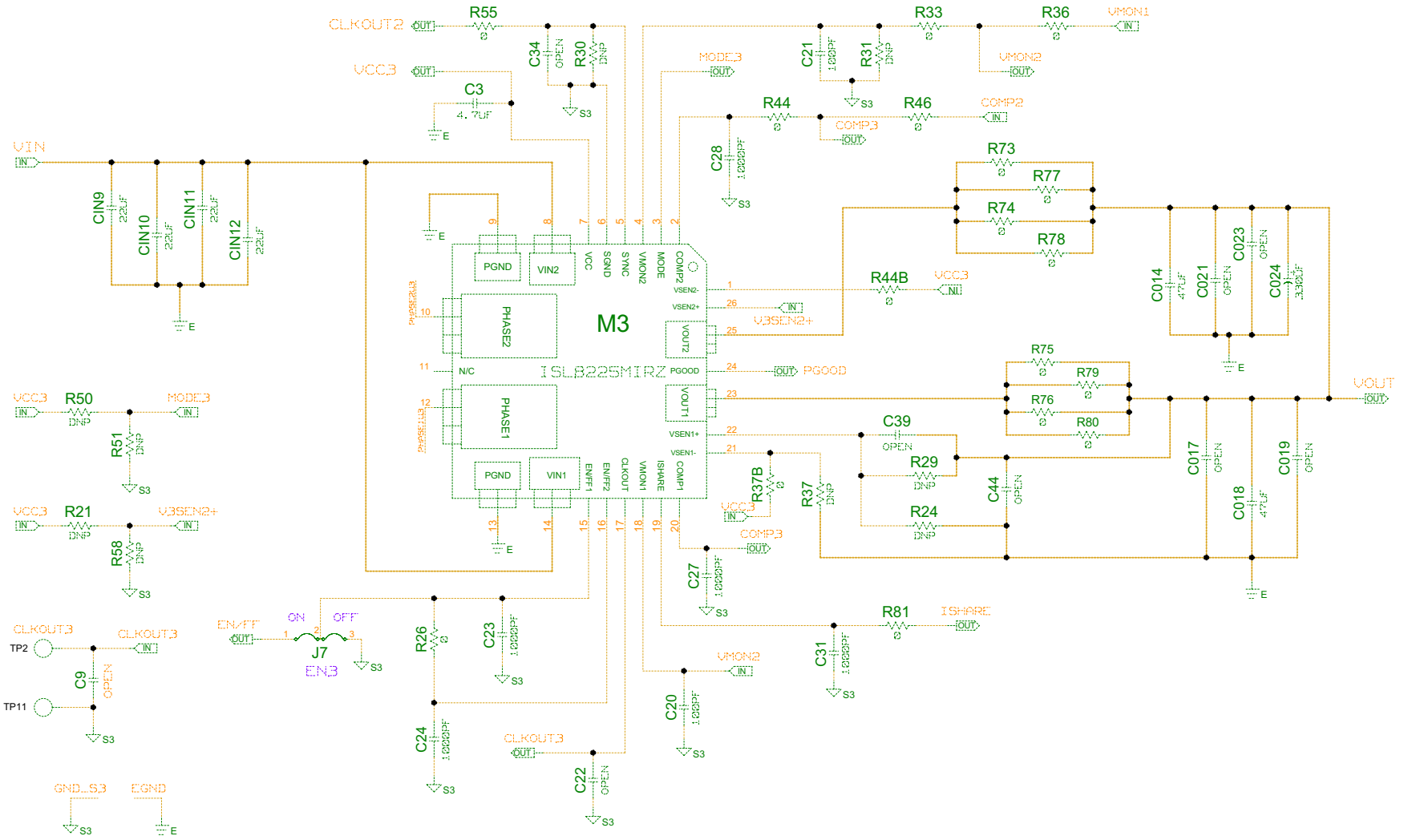

FIGURE 4. ISL8225MEVAL2Z BOARD SCHEMATIC

## Layout

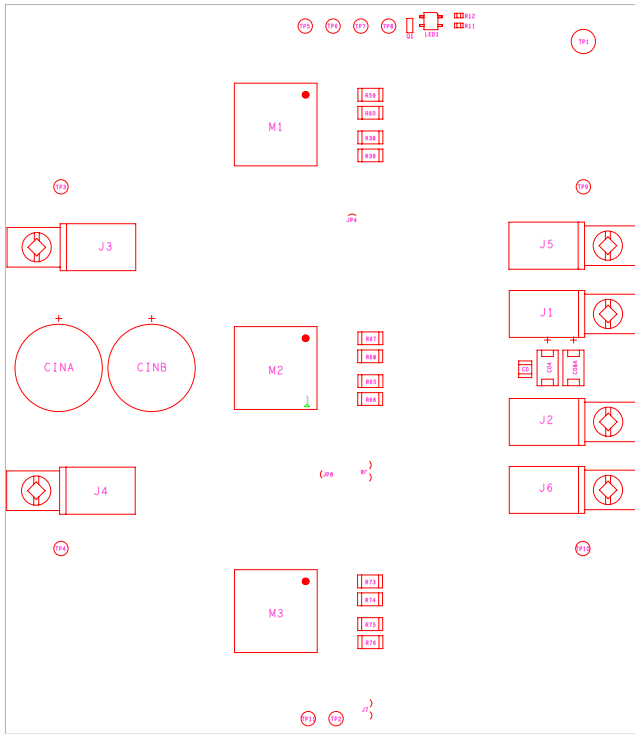

FIGURE 5. TOP ASSEMBLY

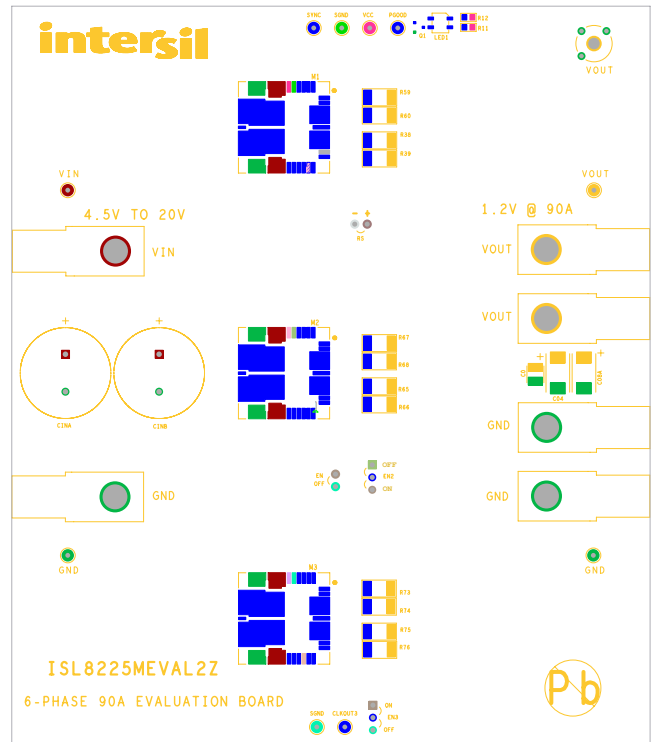

FIGURE 6. TOP SILK SCREEN

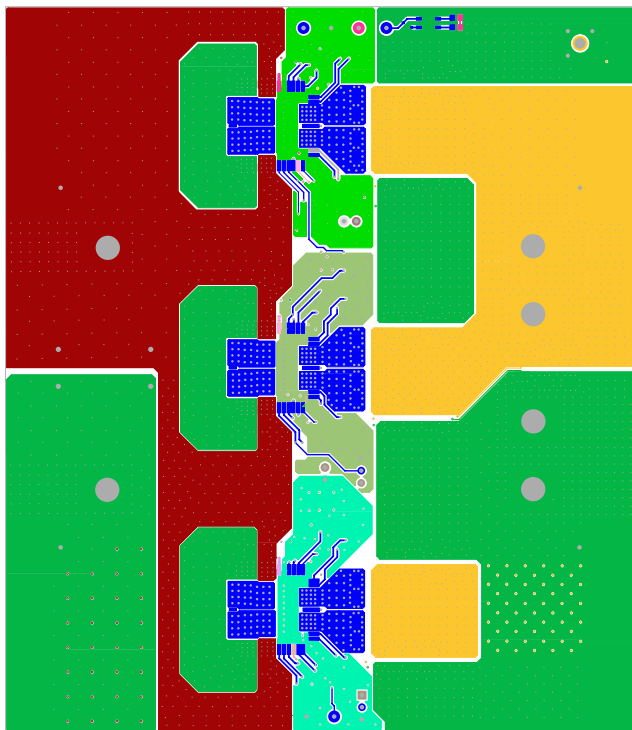

FIGURE 7. TOP LAYER COMPONENT SIDE

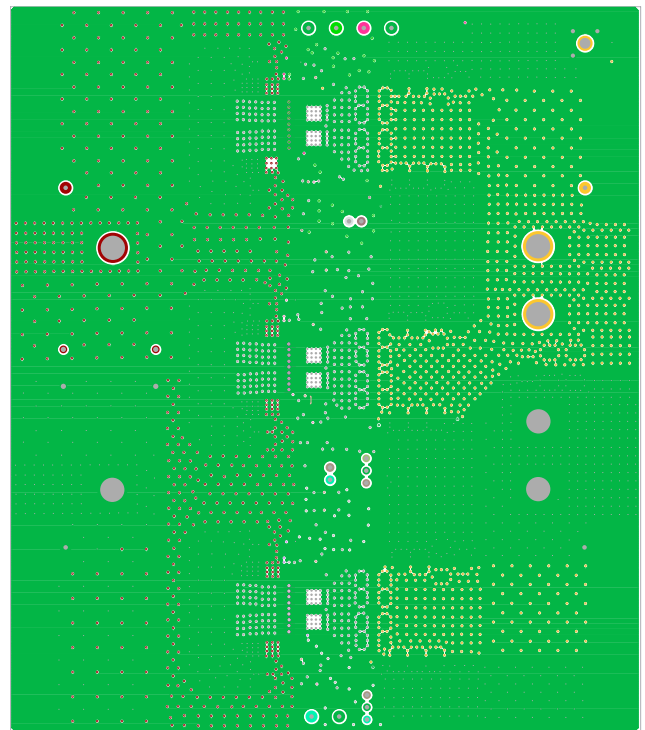

FIGURE 8. LAYER 2

Layout (Continued)

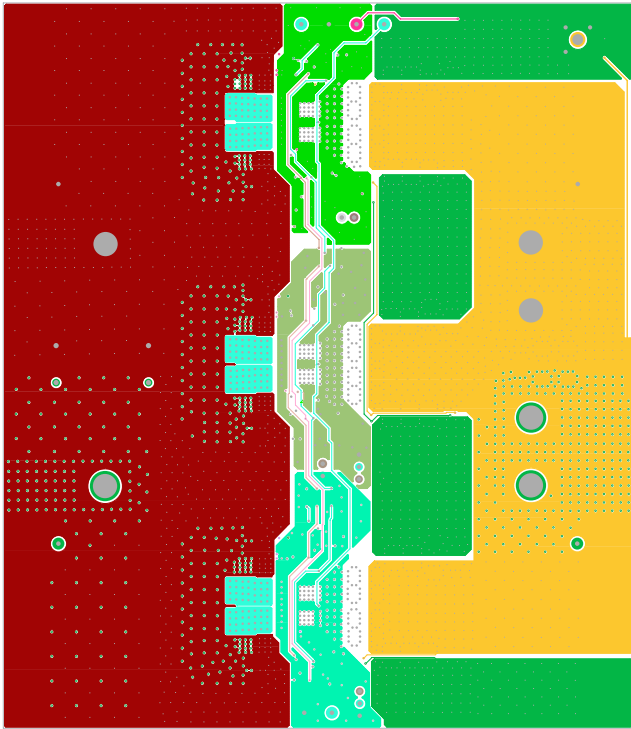

FIGURE 9. LAYER 3

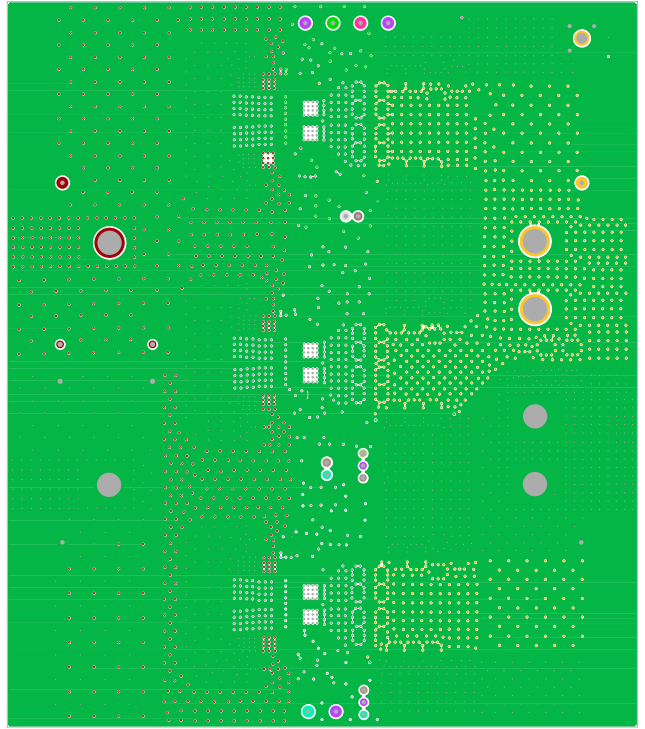

FIGURE 10. LAYER 4

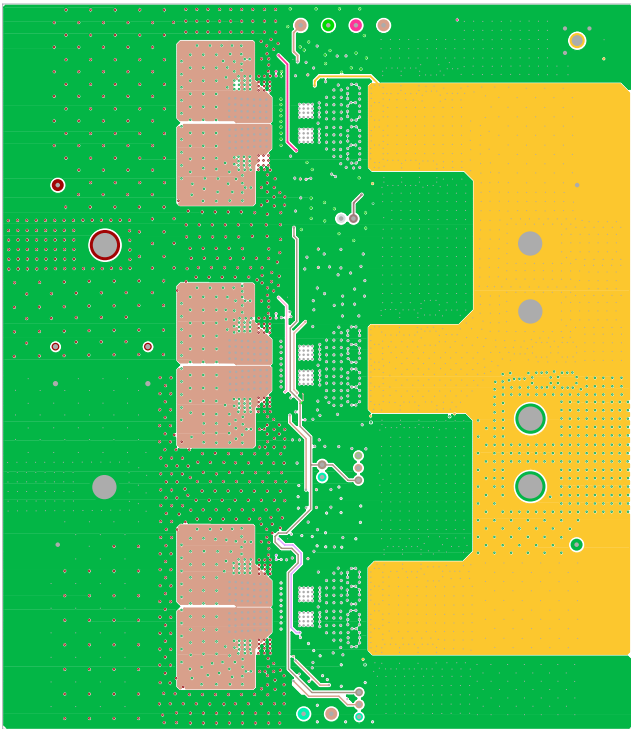

FIGURE 11. LAYER 5

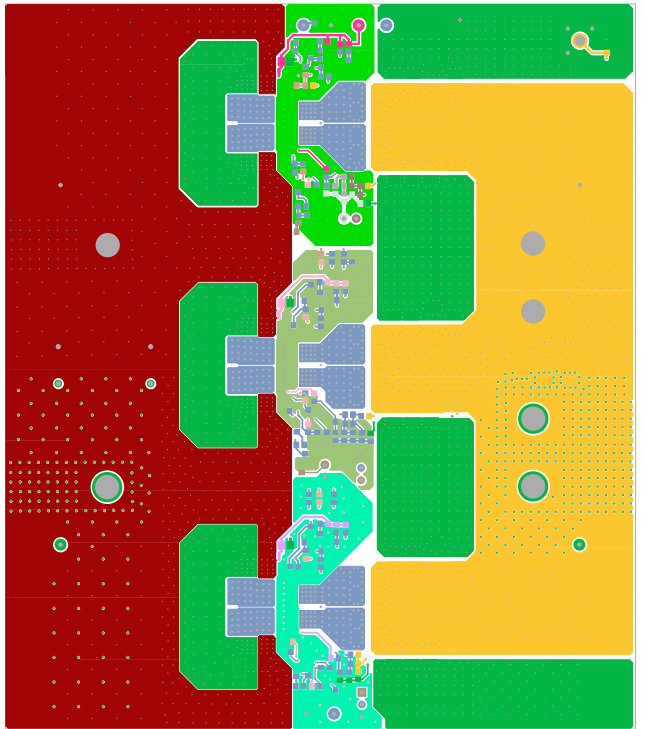

FIGURE 12. BOTTOM LAYER SOLDER SIDE



## Layout (Continued)

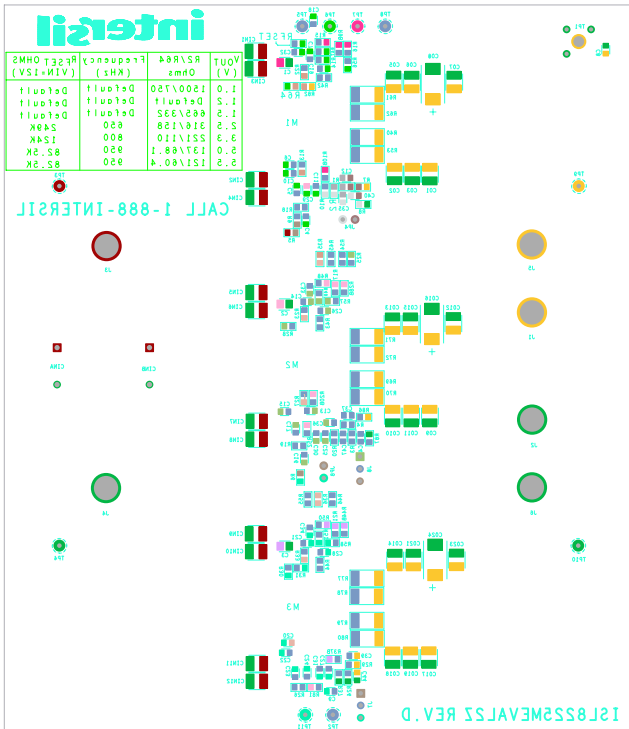

FIGURE 13. BOTTOM SILK SCREEN

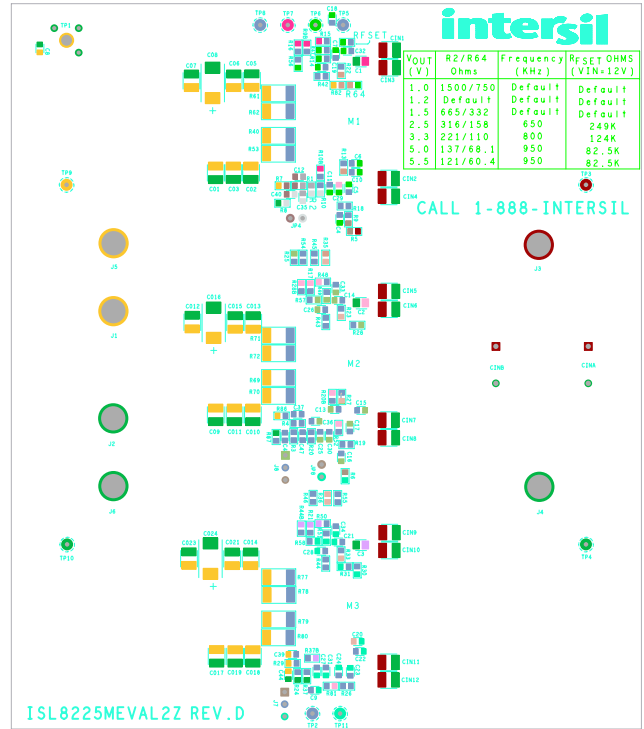

FIGURE 14. BOTTOM SILK SCREEN MIRRORED

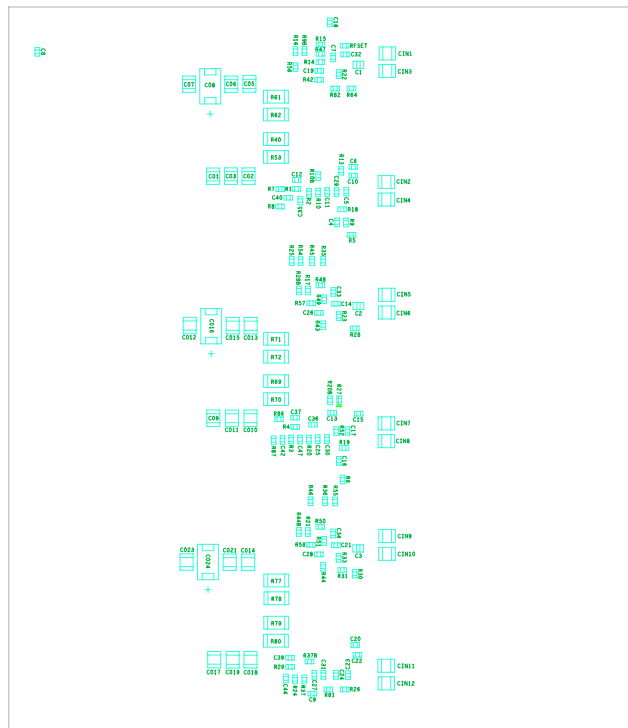

FIGURE 15. BOTTOM ASSEMBLY

# Bill of Materials

PART NUMBER	REF DES	QTY.	VALUE	TOL.	VOLTAGE	POWER	PACKAGE TYPE	JEDEC TYPE	MANUFACTURER	DESCRIPTION
10TPB330M	C04, C08, C016, C024, C08A	5	330µF	20%	10V		SMD	CAP_7343_149	SANYO-POSCAP	Standard solid electrolytic chip tantalum SMD capacitor
131-4353-00	TP1	1					CONN	TEK131-4353-00	Tektronix	Scope probe test point PCB mount
2N7002-7-F	Q1	1					SOT23	SOT23	Fairchild	N-Channel EMF effect transistor (Pb-free)
5002	TP2-TP11	10					THOLE	MTP500X	Keystone	Miniature white test point 0.100 pad 0.040 Thole
ECA-1VM471	CINA, CINB	2	470µF	20%	35V		RADIAL	CAPR_708X1398_300_P	Panasonic	Radial capacitor Pb-free
GRM21BR71C475KA73L	C1-C3	3	4.7µF	10%	16V		805	CAP_0805	Murata	Ceramic capacitor
GRM32ER70A476K	C0, C02, C05, C010, C013, C014, C018	7	47µF	10%	10V		1210	CAP_1210	Murata	Ceramic chip capacitor
GRM32ER71E226KE15L	CIN1-CIN12	12	22µF	10%	25V		1210	CAP_1210	Murata	Ceramic chip capacitor
H1045-00101-50V10	C6, C7, C13, C14, C20, C21	6	100pF	10%	50V		603	CAP_0603	Generic	Multilayer capacitor
H1045-00102-16V10	C8	1	1000pF	10%	16V		603	CAP_0603	Generic	Multilayer capacitor
H1045-00102-50V10	C4, C5, C9, C11, C16-C19, C23-C31, C40	18	1000pF	10%	50V		603	CAP_0603	Generic	Multilayer capacitor
H1045-00103-50V10	C35	1	0.01µF	10%	50V		603	CAP_0603	Generic	Multilayer capacitor
H1045-OPEN	C10, C12, C15, C22, C32-C34, C36, C37, C39, C42, C44, C47	13	OPEN	5%	OPEN		603	CAP_0603	Generic	Multilayer capacitor
H1082-OPEN	C01, C03, C06, C07, C09, C011, C012, C015, C017, C019, C021, C023	12	OPEN	10%	OPEN		1210	CAP_1210	Generic	Ceramic chip capacitor
H2505-DNP-DNP-1	R3, R4, R13-R17, R20, R21, R24, R25, R28-R31, R37, R48, R50, R51, R56-R58, R86, R87, R10B, RFSET	26	DNP	1%		DNP	603	RES_0603	Generic	Metal film chip resistor (do not populate)

# Bill of Materials (Continued)

PART NUMBER	REF DES	QTY.	VALUE	TOL.	VOLTAGE	POWER	PACKAGE TYPE	JEDEC TYPE	MANUFACTURER	DESCRIPTION
H2511-00R00-1/16W1	R7-R10, R18, R19, R22, R23, R26, R27, R33, R35, R36, R42-R47, R49, R52, R54, R55, R81, R9B, R20B, R28B, R37B, R44B	29	0Ω	1%		1/16W	603	RES_0603	Generic	Thick film chip resistor
H2511-01001-1/16W1	R1, R2, R6	3	1kΩ	1%		1/16W	603	RES_0603	Generic	Thick film chip resistor
H2511-03321-1/16W1	R11, R12	2	3.32kΩ	1%		1/16W	603	RES_0603	Generic	Thick film chip resistor
H2511-04990-1/16W1	R64, R82	2	499Ω	1%		1/16W	603	RES_0603	Generic	Thick film chip resistor
H2520-00R00-1/2W5	R38-R40, R53, R59-R62, R65-R80	24	0Ω	5%		1/2W	2010	RES_2010	Generic	Thick film chip resistor
ISL8225MIRZ	M1-M3	3					QFN	QFN26_670X670_ISL8225M	Intersil	Dual 15A DC/DC power module
JUMPER-3-100	J7, J8	2					THOLE	JUMPER-3	Generic	Three pin jumper
JUMPER2_100	JP4, JP8	2					THOLE	JUMPER-1	Generic	Two pin jumper
KPA8CTP	J1-J6	6					CONN	KPA8CTP	Burndy	Wire connector lug
MCR03EZPFX3001	R5	1	3kΩ	1%		1/10W	603	RES_0603	ROHM	Metal film chip resistor
SSL-LXA3025IGC	LED1	1					SMD	LED_3X2_5MM	Lumex	3mmx2.5mm surface mount red/green LED

**NOTE:**

- Resistance accuracy of the feedback resistor divider R1/R2 can affect the output voltage accuracy. Please use high accuracy resistance (i.e. 0.5% or 0.1%) to meet the output accuracy requirement.

## ISL8225MEVAL2Z Efficiency Curves Test conditions at +25 °C and no air flow.

### Efficiency Curves with Zero-ohm Resistance on the Output

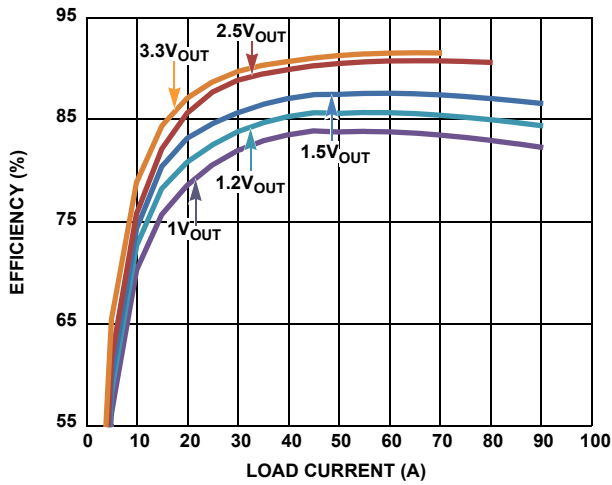

FIGURE 16. EFFICIENCY CURVES FOR 12V INPUT

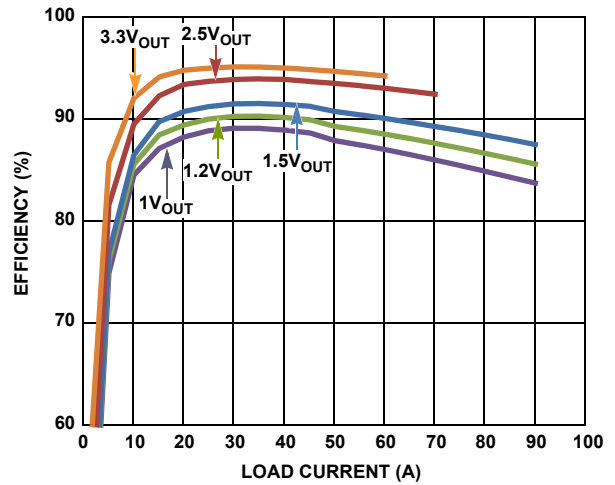

FIGURE 17. EFFICIENCY CURVES FOR 5V INPUT

### Efficiency Curves by Replacing Zero-ohm Resistance with Thick Copper Strap

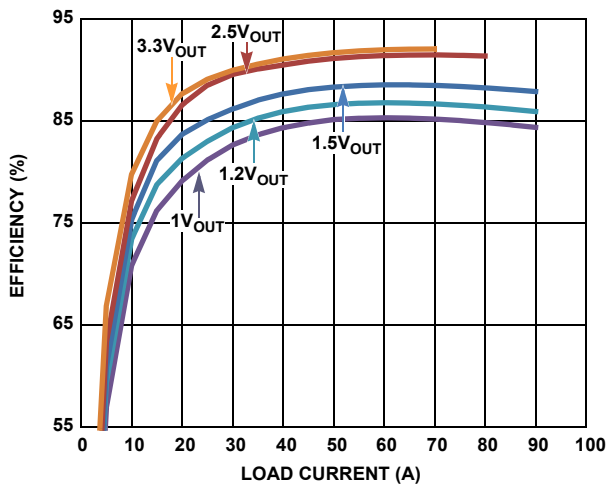

FIGURE 18. EFFICIENCY CURVES FOR 12V INPUT

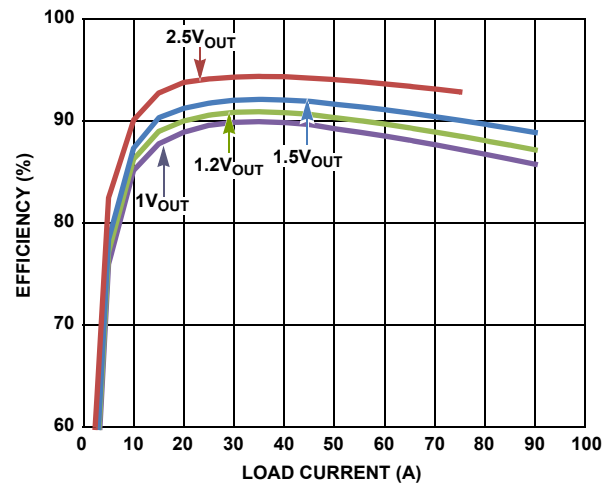

FIGURE 19. EFFICIENCY CURVES FOR 5V INPUT

Intersil Corporation reserves the right to make changes in circuit design, software and/or specifications at any time without notice. Accordingly, the reader is cautioned to verify that the Application Note or Technical Brief is current before proceeding.

For information regarding Intersil Corporation and its products, see [www.intersil.com](http://www.intersil.com)